

# DKM-430

## MULTIPLE NETWORK ANALYSER

### DESCRIPTION

**DATAKOM DKM-430** is a precision instrument allowing the measurement, recording and remote monitoring of 10 3-phased or 30 single-phased feeders (or any combination of these two). The number and flexibility of current inputs allow the unit to be used in a variety of applications like power distribution network monitoring, ISO50001 energy efficiency or home and factory automation.

The unit can be mounted on a DIN rail or backplane. It can be easily adapted to existing panels.

Current inputs of the unit are designed for 0.1A output current transformers (CTs). Different 0.1A rated CTs are available at Datakom for sales.

Each CT can be assigned to any phase voltage and any virtual analyzer. Inputs can be moved between analyzers without modifying connections.

Independently adjustable current limits for each phase provide pre-alarms and help to reduce energy failures.

All measurement values and program parameters may be displayed on the graphic LCD screen.

The unit logs all fault conditions together with date and time information. The internal real time clock is capable of running 10 years without energy.

The astronomical relay function calculates sunrise and sunset times precisely for daylight based applications.

Any fault or warning signal can be connected to digital inputs of the unit. Input functions are selected from list.

Any function can be assigned to relay outputs of the unit. Relays may be remotely operated through the central monitoring program.

The isolated RS-485 MODBUS RTU data port is unaffected by ground potential differences and allows safe transmission of information to monitoring and automation systems.

The optional internal GPRS modem allows remote monitoring and control of the distribution panel without the use of any additional module.

Parameter setting of the unit is made either manually or through the USB port using the free PC program.

The unit records electrical parameters in its 1MB internal memory with programmed period. Records are read through Modbus.

### FEATURES

**Equivalent to 10 3-phase analyzers**

**True RMS measurements**

**0.5% measurement precision**

**Internal record memory: 1MB**

**Internal battery backed-up real time clock**

**Astronomical relay function**

**Isolated RS-485 serial port**

**MODBUS-RTU communication**

**Internal GPRS modem (optional)**

**2 programmable relay outputs**

**2 optically isolated programmable inputs**

**Active-reactive energy counters**

**USB port for programming**

**Free programming software**

**Graphic LCD, 128x64 pixels**

**Wide supply range: 85-305VAC / 88-450VDC**

**DC supply version available**

**Wide operating temperature range**

### MEASUREMENTS

#### VOLTAGE INPUTS:

- P-N and P-P voltages: V1-V2-V3-U12-U23-U31
- Harmonics: Voltage inputs, 2-17 harmonics

#### EACH CT INPUT:

- Current: In
- Active/reactive/apparent powers: Pn-Qn-Sn
- Power factor: COSn
- Current harmonics 2-17

#### EACH VIRTUAL ANALYSER:

- Total active/reactive/apparent power:  $\sum P - \sum Q - \sum S$
- Total power factor:  $\sum \cos$
- Active and reactive counters: Pn-Qn



## COPYRIGHT NOTICE

Any unauthorized use or copying of the contents or any part of this document is prohibited.

## ABOUT THIS DOCUMENT

This document describes minimum requirements and necessary steps for the successful installation of the DKM-430 family units.

Follow carefully advices given in the document. These are often good practices for the installation which reduce future issues.

For all technical queries please contact Datakom at below e-mail address:

**datakom@datakom.com.tr**

## QUERRIES

If additional information to this manual is required, please contact the manufacturer directly at below e-mail address:

**datakom@datakom.com.tr**

Please provide following information in order to get answers to any question:

- Device model name (see the back panel of the unit),
- Complete serial number (see the back panel of the unit),
- Firmware version (read from the display screen),
- Measuring-circuit voltage and power supply voltage,
- Precise description of the query.

## RELATED DOCUMENTS

FILENAME	DESCRIPTION
500-Rainbow Installation	Rainbow Plus D-500 D-700 Installation Guide
500-Rainbow Usage	Rainbow Plus D-500 D-700 Usage Guide
500-Rainbow Scada Installation	Rainbow Scada Installation Guide
500-Rainbow Scada Usage	Rainbow Scada Usage Guide

## REVISION HISTORY

REVISION	DATE	AUTHOR	DESCRIPTION
01	15.06.2015	MH	First edition
02	15.02.2017	ME	Modbus addresses updated

## TERMINOLOGY



**CAUTION:** Potential risk of injury or death.



**WARNING:** Potential risk of malfunction or material damage.



**ATTENTION:** Useful hints for the understanding of device operation.

## ORDERING CODES

The D-500 family units are available in various options and peripheral features. Please use below information for ordering the correct version:

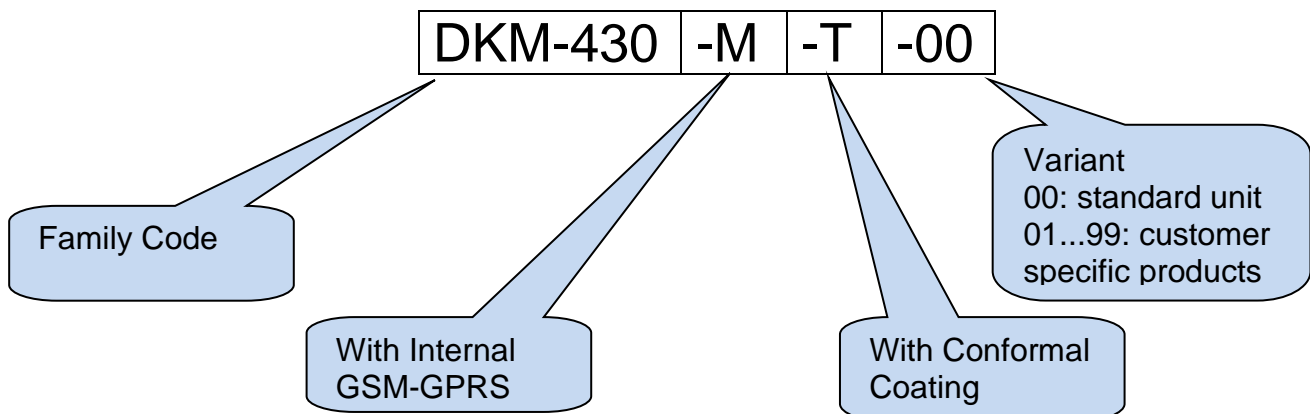



### SAFETY NOTICE

**Failure to follow below instructions  
will result in death or serious injury**



- Electrical equipment should be installed only by qualified specialist. No responsibility is assured by the manufacturer or any of its subsidiaries for any consequences resulting from the non-compliance to these instructions.

- Check the unit for cracks and damages due to transportation. Do not install damaged equipment.



- Do not open the unit. There are no serviceable parts inside.

- Fuses must be connected to the power supply and phase voltage inputs, in close proximity of the unit.



- Fuses must be of fast type (FF) with a maximum rating of 6A.



- Disconnect all power before working on equipment.



- When the unit is connected to the network do not touch terminals.

- Short circuit terminals of unused current transformers.



- Any electrical parameter applied to the device must be in the range specified in the user manual. Although the unit is designed with a wide safety margin, over-range parameters may reduce lifetime, alter operational precision or even damage the unit.



- Do not try to clean the device with solvent or the like. Only clean with a damp cloth.

- Verify correct terminal connections before applying power.

- Only for panel base mounting.



**Current measurement is made with CTs provided together  
with the module.**

**Do not apply direct connection, do not use 1A/5A current  
transformers.**

## TABLE OF CONTENTS

- 1. INSTALLATION INSTRUCTIONS**
- 2. MOUNTING**
  - 2.1 DIMENSIONS**
  - 2.3 ELECTRICAL INSTALLATION**
- 3. TERMINAL DESCRIPTIONS**
  - 3.1. BATTERY VOLTAGE INPUT**
  - 3.2. AC VOLTAGE INPUTS**
  - 3.3. AC CURRENT INPUTS**
  - 3.4. DIGITAL INPUTS**
  - 3.5. RELAY OUTPUTS**
  - 3.6. RS-485 PORT**
  - 3.7. USB DEVICE PORT**
  - 3.8. GSM MODEM (OPTIONAL)**
- 4. CONNECTION DIAGRAM**
- 5. TECHNICAL SPECIFICATIONS**
- 6. DESCRIPTION OF CONTROLS**
  - 6.1. FRONT PANEL FUNCTIONALITY**
  - 6.2. PUSHBUTTON FUNCTIONS**
  - 6.3. LED FUNCTIONS**
  - 6.4. SCREEN SCROLLING**
- 7. WAVEFORM DISPLAY & HARMONIC ANALYSIS**
- 8. ASTRONOMIC RELAY FUNCTIONALITY**
- 9. PROTECTIONS AND ALARMS**
- 10. PROGRAMMING**
  - 10.1. ENTERING THE PROGRAMMING MODE**
  - 10.2. NAVIGATING BETWEEN MENUS**
  - 10.3. MODIFYING PARAMETER VALUE**
  - 10.4. PROGRAMMING MODE EXIT**

**11. PROGRAM PARAMETER LIST**

- 11.1. CONTROLLER CONFIGURATION GROUP
- 11.2. ELECTRICAL PARAMETERS GROUP
- 11.3. CHANNEL CONFIGURATION
- 11.4. GSM MODEM PARAMETERS
- 11.5. DIGITAL INPUT PARAMETERS
- 11.6. DIGITAL OUTPUT PARAMETERS
- 11.7. USER INPUT SCREENS
- 11.8. DEMAND AND COUNTERS
- 11.9. USER SCREENS
- 11.10. DEVICE CALIBRATION
- 11.11. ADJUST DATE AND TIME
- 11.12. CHANGE PASSWORD
- 11.13. RETURN TO FACTORY SETTINGS
- 11.14. LOCATION SETUP

**12. INTERNAL RECORD MEMORY****13. CENTRAL MONITORING OF UNITS****14. E-MAIL SENDING****15. SMS COMMANDS****16. MODBUS COMMUNICATIONS**

- 16.1. PARAMETERS REQUIRED FOR RS-485 MODBUS OPERATION
- 16.2. DATA FORMATS
- 16.3. EXCHANGE BUFFER
- 16.4. DATE-TIME AND LOCATION ARRAY
- 16.5. COUNTERS ARRAY
- 16.6. COMMANDS ARRAY
- 16.7. MEASUREMENTS ARRAY
- 16.8. ANALYZER BLOCKS
- 16.9. DIGITAL INPUTS AND OUTPUTS
- 16.10. HARMONIC ANALYSIS
- 16.11. OSCILLOGRAPHIC RECORDS
- 16.12. DEVICE INFORMATION
- 16.13. ALARM INFORMATION

**17. DECLARATION OF CONFORMITY****18. MAINTENANCE****19. DISPOSAL OF THE UNIT****20. ROHS COMPLIANCE****21. TROUBLESHOOTING GUIDE**

## 1. INSTALLATION INSTRUCTIONS

### **Before installation:**

- Read the user manual carefully, determine the correct connection diagram.
- Install to the panel base or DIN rail. In order to install to panel base, pull mounting tabs at corners.
- Make electrical connections with plugs removed from sockets, then place plugs to their sockets.
- Be sure that adequate cooling is provided.
- Be sure that the temperature of the environment will not exceed the maximum operating temperature in any case.
- Be sure that the unit is not subject to water spill.

### **Below conditions may damage the device:**

- Incorrect connections.
- Incorrect power supply voltage.
- Voltage at measuring terminals beyond specified range.
- Voltage applied to digital inputs over specified range.
- Current at measuring terminals beyond specified range.
- Overload or short circuit at relay outputs
- Connecting or removing data terminals when the unit is powered-up.
- High voltage applied to communication ports.
- Ground potential differences at non-isolated communication ports.
- Excessive vibration, direct installation on vibrating parts.



**Current measurement is made with CTs provided together with the module.**

**Do not apply direct connection, do not use 1A/5A current transformers.**

### **Below conditions may cause abnormal operation:**

- Power supply voltage below minimum acceptable level.
- Power supply frequency out of specified limits
- Phase order of voltage inputs not correct.
- Current transformers not matching related phases.
- Current transformer polarity incorrect.
- Missing grounding.

## 2. MOUNTING

### 2.1. DIMENSIONS

**Dimensions:** 158x90x60mm (6.22"x3.55"x2.36")

**Installation:** Panel base or DIN rail

**Weight:** 350g (0.77 lb)

### 2.2. ELECTRICAL INSTALLATION



**Do not install the unit close to high electromagnetic noise emitting devices like contactors, high current busbars, switchmode power supplies and the like.**

Although the unit is protected against electromagnetic disturbance, excessive disturbance can affect the operation, measurement precision and data communication quality.

- **ALWAYS** remove plug connectors when inserting wires with a screwdriver.
- Fuses must be connected to the power supply and phase voltage inputs, in close proximity of the unit.
- Fuses must be of fast type (FF) with a maximum rating of 6A.
- Use cables of appropriate temperature range.
- Use adequate cable section, at least 0.75mm<sup>2</sup> (AWG18).
- Follow national rules for electrical installation.
- Current transformers must have 0.1A output.



**Current measurement is made with CTs provided together with the module.**

**Do not apply direct connection, do not use 1A/5A current transformers.**



### 3. TERMINAL DESCRIPTIONS

#### 3.1. BATTERY VOLTAGE INPUT

<b>Supply voltage:</b>	<b>AC SUPPLY VERSIONS:</b> 85-305VAC, 45-65Hz, 88-450VDC <b>DC SUPPLY VERSIONS:</b> 19-150VDC
<b>Reverse voltage:</b>	Non polarized inputs, works in both polarizations.
<b>Maximum input power:</b>	6W
<b>Typical operating current:</b>	250mA @ 12VDC. (all options passive, digital outputs open) 125mA @ 24VDC. (all options passive, digital outputs open)
<b>Maximum operating current:</b>	30mA @ 230VAC. (all features active, digital outputs open) 60mA @ 110VDC. (all features active, digital outputs open)

#### 3.2. AC VOLTAGE INPUTS

<b>Measurement method:</b>	True RMS
<b>Sampling rate:</b>	2048 Hz
<b>Harmonic analysis:</b>	up to 17th harmonic
<b>Input voltage range:</b>	5 to 300 VAC (phase-neutral)
<b>Measurement range:</b>	0 to 330VAC ph-N (0 to 570VAC ph-ph)
<b>Input impedance:</b>	4.5M-ohms
<b>Display resolution:</b>	0.1VDC
<b>Accuracy:</b>	0.5% + 1 digit @ 230VAC ph-N ( $\pm 2$ VAC ph-N) 0.5% + 1 digit @ 400VAC ph-ph ( $\pm 3$ VAC ph-ph)

<b>Frequency range:</b>	45 to 65 Hz
<b>Frequency display resolution:</b>	0.01 Hz
<b>Frequency accuracy:</b>	0.2% + 1 digit ( $\pm 0.1$ Hz @ 50Hz)

### 3.3. AC CURRENT INPUTS

<b>Measurement method:</b>	True RMS
<b>Sampling rate:</b>	2048 Hz
<b>Harmonic analysis:</b>	up to 17th harmonic
<b>CT secondary rating:</b>	100mA
<b>Measurement range:</b>	5/0.1 to 5000/0.1A minimum
<b>Input impedance:</b>	1 ohm
<b>Burden:</b>	10 mW
<b>Maximum continuous current:</b>	500mA
<b>Measurement range:</b>	0.5 to 120mAA
<b>Display resolution:</b>	0.1A
<b>Accuracy:</b>	0.5% + 1 digit @ 100mA

#### **SELECTING THE CT ACCURACY CLASS:**

The CT accuracy class should be selected in accordance with the required measurement precision. The accuracy class of the Datakom controller is 0.5%. Thus 0.5% class CTs are advised for the best result.

**CONNECTING CTs:**

Be sure of connecting each CT to the related phase input with the correct polarity. Mixing CTs between phases will cause faulty power and pf readings.

Many combinations of incorrect CTs connections are possible, so check both order of CTs and their polarity. Reactive power measurement is affected by incorrect CTs connection in similar way as active power measurement.

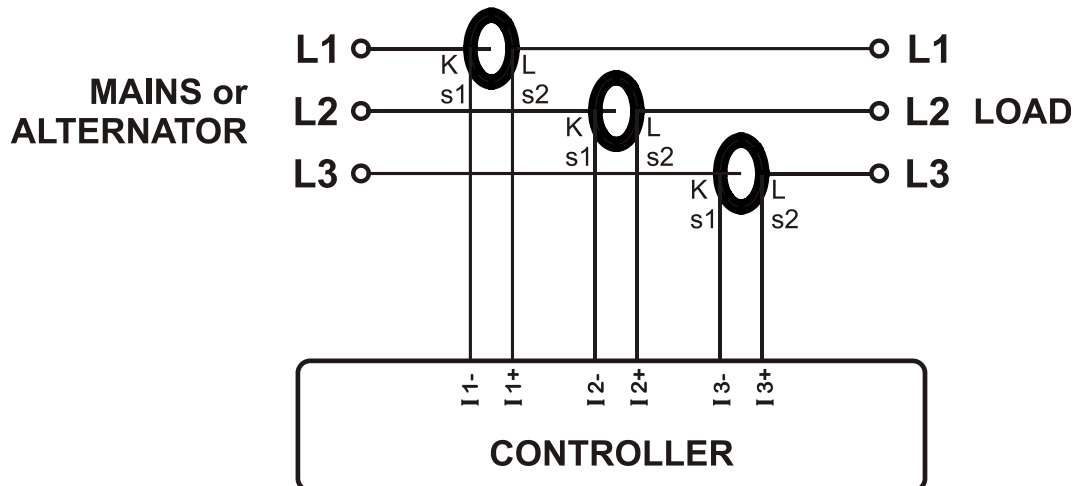
**CORRECT CT CONNECTIONS**

Let's suppose that the network is loaded with 100 kW on each phase. The load Power Factor (PF) is 1. Measured values are as follows:

	kW	kVAr	kVA	pf
Phase L1	100.0	0.0	100	1.00
Phase L2	100.0	0.0	100	1.00
Phase L3	100.0	0.0	100	1.00
<b>Total</b>	<b>300.0</b>	<b>0.0</b>	<b>300</b>	<b>1.00</b>

**EFFECT OF POLARITY REVERSAL**

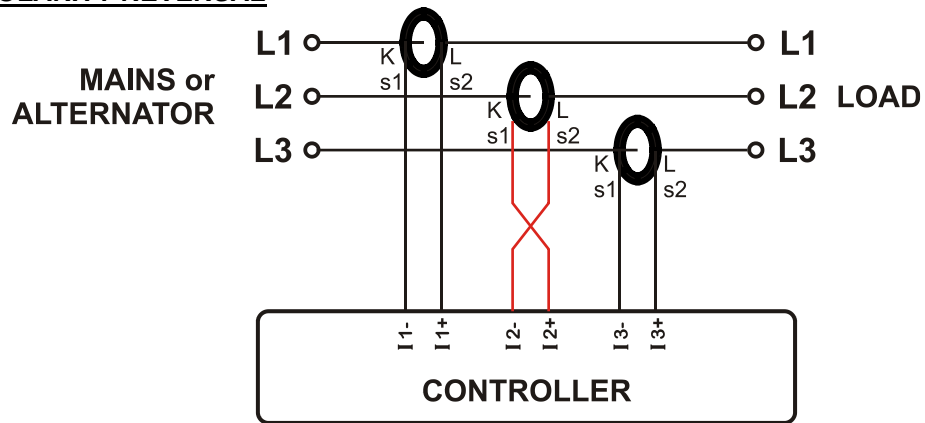

The network is still loaded with 100 kW On each phase. The load Power Factor (PF) is 1. PF in phase L2 will show -1,00 due to reverse CT polarity. The result is that total network power displayed by the controller is 100 kW.

Measured values are as follows:

	kW	kVAr	kVA	pf
Phase L1	100.0	0.0	100	1.00
Phase L2	-100.0	0.0	100	-1.00
Phase L3	100.0	0.0	100	1.00
<b>Total</b>	<b>100.0</b>	<b>0.0</b>	<b>300</b>	<b>0.33</b>

**EFFECT OF PHASE SWAPPING**

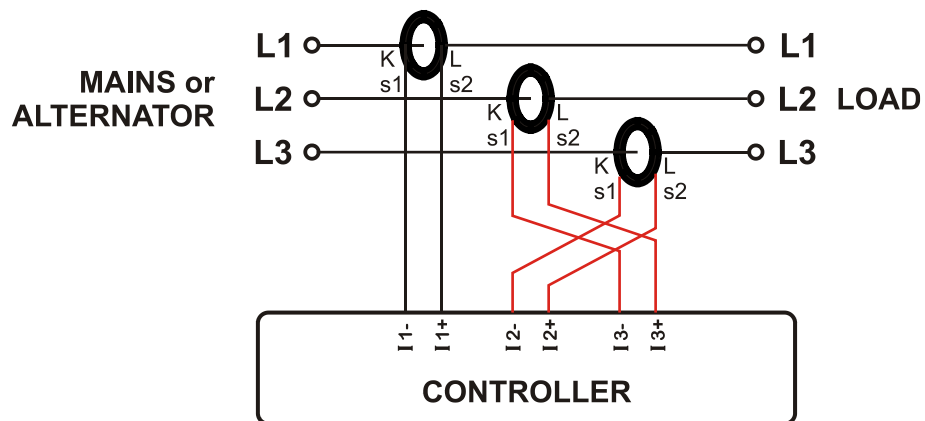

The network is still loaded with 100 kW on each phase. The load Power Factor (PF) is 1. PF in phases L2 and L3 will show -0,50 due to phase shift between voltages and currents which is caused by CT swapping. The result is that total network power displayed by controller is 0 kW.

Measured values are as follows:

	kW	kVAr	kVA	pf
Phase L1	100.0	0.0	100	1.00
Phase L2	-50.0	86.6	100	-0.50
Phase L3	-50.0	-86.6	100	-0.50
<b>Total</b>	<b>0.0</b>	<b>0.0</b>	<b>300</b>	<b>0.0</b>

### 3.4. DIGITAL INPUTS

<b>Number of inputs:</b>	2 inputs, all configurable
<b>Input type:</b>	Opto-isolated digital input
<b>Function selection:</b>	from list
<b>Contact type:</b>	Normally open or normally closed (programmable)
<b>Minimum pulse duration:</b>	250ms
<b>Active level:</b>	85-305VAC
<b>Isolation:</b>	1000VAC, 1 minute
<b>Noise filtering:</b>	yes

### 3.5. RELAY OUTPUTS

<b>Structure:</b>	Relay output, normally open contact. One terminal is internally connected to the common terminal for both relays.
<b>Max switching current:</b>	5A @250VAC
<b>Max switching voltage:</b>	250VAC
<b>Max switching power:</b>	1250VA

### 3.6. RS-485 PORT

<b>Structure:</b>	RS-485, isolated.
<b>Connection:</b>	3 wires (A-B-GND). Half duplex.
<b>Baud rate:</b>	2400-115200 bauds, selectable
<b>Data type:</b>	8 bit data, no parity, 1 bit stop
<b>Termination:</b>	External 120 ohms required
<b>Common mode voltage:</b>	-0.5 VDC to +7VDC, internally clamped by transient suppressors.
<b>Max distance:</b>	1200m @ 9600 bauds (with 120 ohms balanced cable) 200m @ 115200 bauds (with 120 ohms balanced cable)
<b>Isolation:</b>	1000VAC, 1 minute

The RS-485 port features MODBUS-RTU protocol. Multiple modules (up to 128) can be paralleled on the same RS-485 bus for data transfer to automation or building management systems.

The RS-485 port provides also a good solution for distant PC connection where RainbowPlus program will enable programming, control and monitoring.

### 3.7. USB PORT

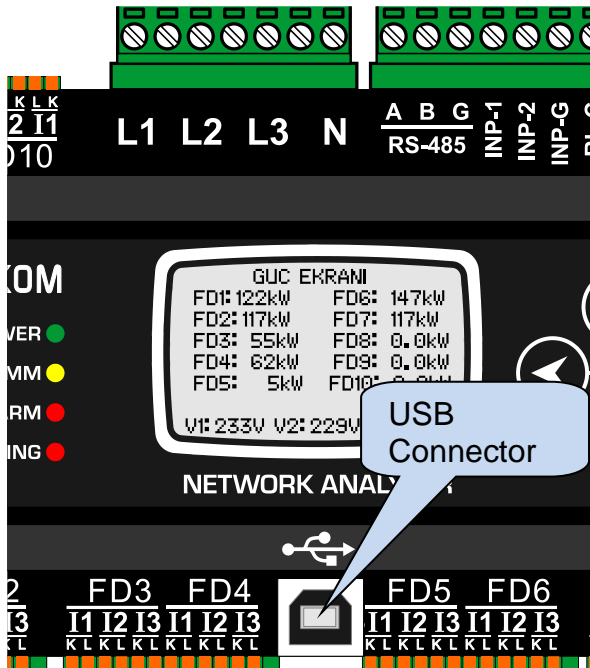

<b>Description:</b>	USB 2.0, not isolated, HID mode
<b>Data rate:</b>	Full Speed 1.5/12 Mbits/s, auto detecting
<b>Connector:</b>	USB-B (printer connector)
<b>Cable length:</b>	Max 6m
<b>Functionality:</b>	Modbus, FAT32 for firmware upgrade (boot loader mode only)

The USB-Device port is designed to connect the module to a PC. Using the RainbowPlus software, programming, control of the genset and monitoring of measured parameters are achieved.

The RainbowPlus software can be downloaded from [www.datakom.com.tr](http://www.datakom.com.tr) website.

The connector on the module is of USB-B type. Thus A to B type USB cable should be used. This is the same cable used for USB printers.

For more details about programming, control and monitoring please refer to RainbowPlus user manual.



**If USB connector provides also power supply to the unit. During computer connection additional supply is not required.**

### 3.8. GSM MODEM (OPTIONAL)

The optional internal GSM modem offers the advantage of being internally powered and is fully compatible with the unit. It does not require any special setup.

The 1800/1900 MHz magnetic antenna together with its 2 meter cable is supplied with the internal modem option. The antenna is intended to be placed outside of the genset panel for the best signal reception.

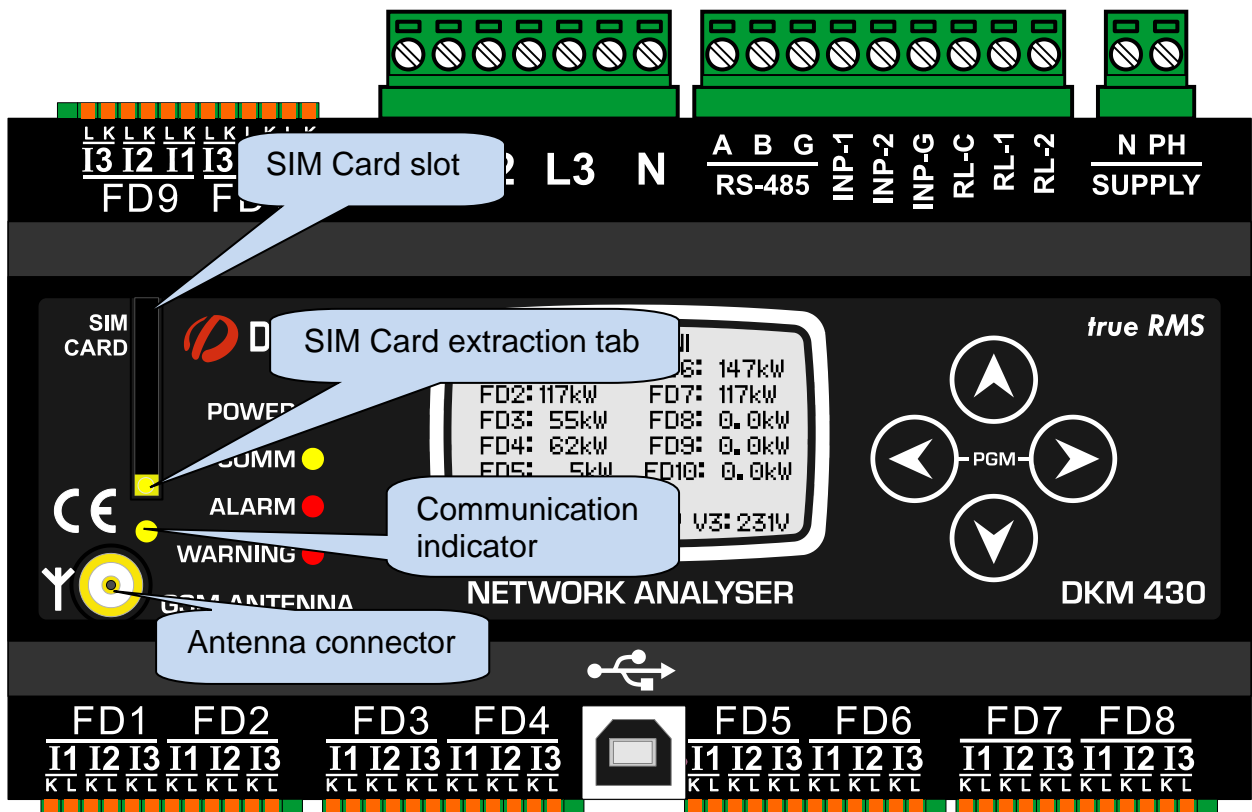

The module requires a GPRS enabled SIM card for full functionality. Voice-only type SIM cards will usually not function properly.

Please refer to **GSM Modem Configuration Guide** for more details.

<b>Description:</b>	Quad-band GSM/GPRS 850/900/1800/1900MHz module. GPRS multi-slot class 12/10 GPRS mobile station class B Compliant to GSM phase 2/2+. – Class 4 (2 W @850/ 900 MHz) – Class 1 (1 W @ 1800/1900MHz)
<b>Functionality:</b>	Web Client, SMTP, Modbus TCP/IP (client), SMS, e-mail
<b>Operating temp range:</b>	-40°C to +85 °C
<b>Data speed:</b>	max. 85.6 kbps (download), 85.6 kbps (upload)
<b>SIM card type:</b>	external SIM 3V/1.8V, GPRS enabled
<b>Antenna:</b>	Quad band, magnetic, with 2m cable
<b>Module certificates:</b>	CE, FCC, ROHS, GCF, REACH

## 4. CONNECTION DIAGRAM

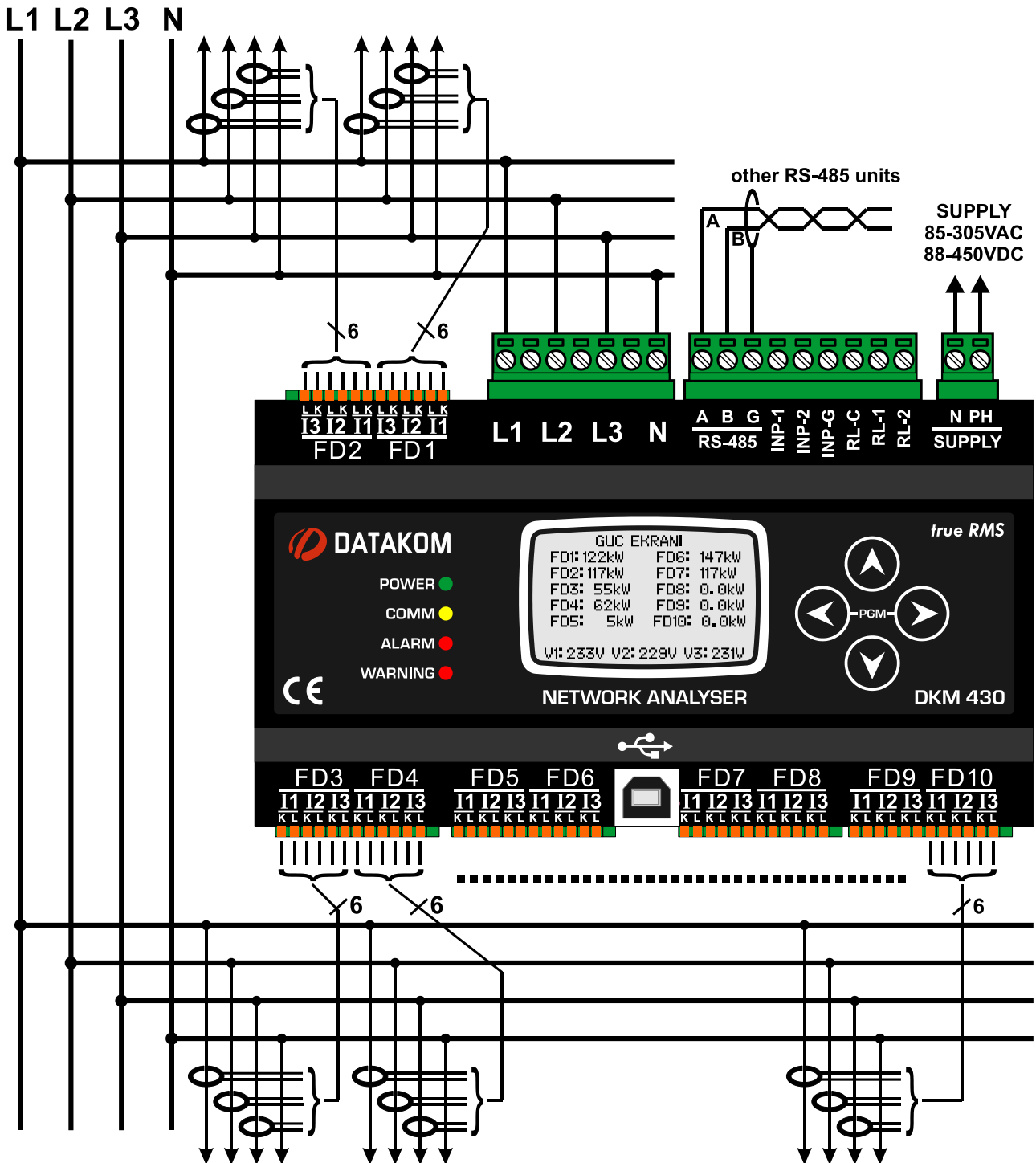



## 5. TECHNICAL SPECIFICATIONS

**Supply Input:**

85 - 305VAC, 50/60Hz,  
88 - 450VDC  
Optional 19-150VDC

**Measurement Inputs:**

**Voltage:** 7 - 300 V AC (P-N)  
14 - 520 V AC (P-P)  
**Current:** 0.001 – 0.12 A AC  
**Frequency:** 45 - 65 Hz

**Accuracy:**

**Voltage:** 0.5% + 1 digit  
**Current:** 0.5% + 1 digit  
**Frequency:** 0.5% + 1 digit  
**Power (kW,kVAr):** 1.0% + 2 digit  
**Cos:** 0.5% + 1 digit

**Measurement Range:**

**CT range:** 5A to 6500A  
**VT range:** 1.0/1 to 5000.0/1  
**kW range:** 1.0 kW to 5000 MW

**Power Consumption:** < 6 VA

**Loading:**

**Voltage Input:** < 0.02VA per phase  
**Current Input:** < 0.02VA per phase

**Relay Outputs:** 5A @ 250V AC

**Digital Inputs:**

**Active level:** 85 – 305VAC  
**Min pulse:** 250ms.  
**Isolation:** 1000V AC, 1 minute

**Serial Port:**

**Signal type:** RS-485  
**Protocol:** Modbus RTU  
**Data Rate:** 2400-115200b adjustable  
**Isolation:** 1000V AC, 1 minute

**Operating Temp. Range:** -20°C to +70 °C (-4°F to 158°F)

**Max Relative Humidity:** 95%, non-condensing

**Case Material:** Flame retardant, ROHS compliant, high temp. ABS/PC (UL94-V0)

**Installation:** DIN rail or backpanel

**Dimensions:** 158x90x60mm (WxHxD)

**Weight:** 350 gr

**AB Directives:**

2006/95/EC (LVD)  
2004/108/EC (EMC)

**Reference Standards:**

EN 61010 (safety)  
EN 61326 (EMC)

## 6. DESCRIPTION OF CONTROLS

### 6.1. FRONT PANEL FUNCTIONALITY

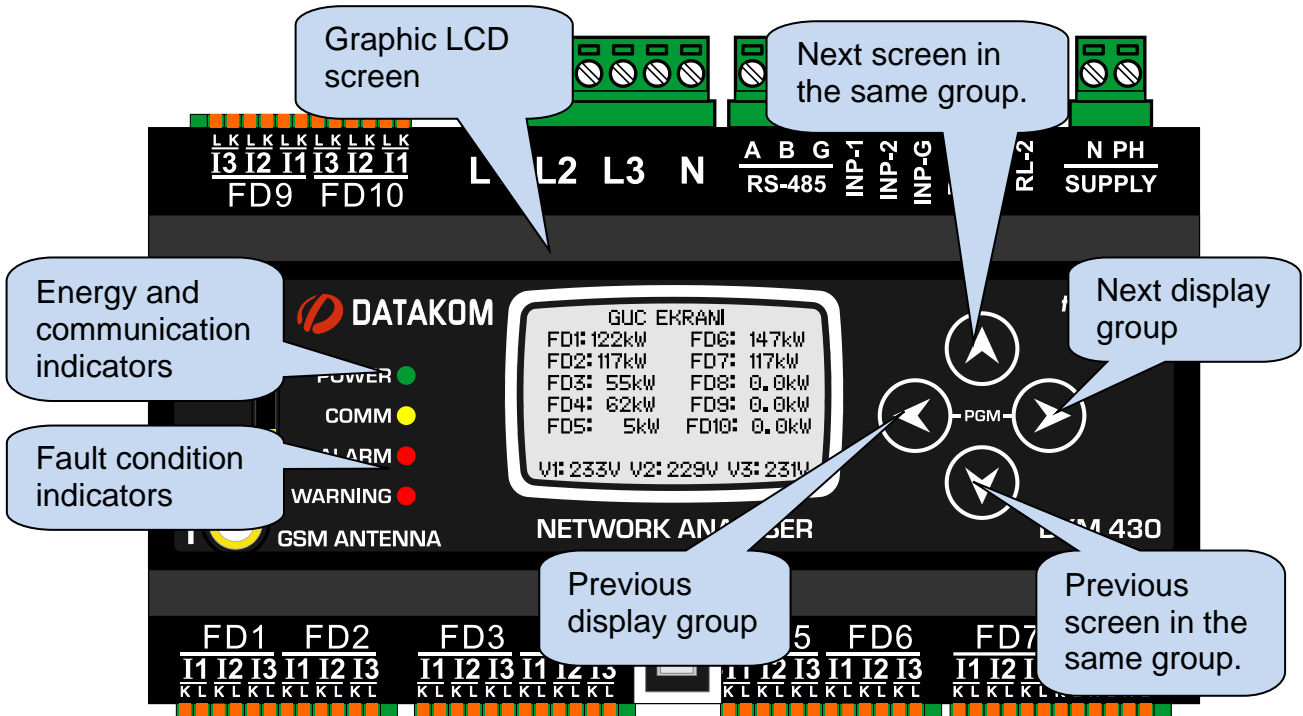

### 6.2. PUSHBUTTON FUNCTIONS

BUTTON	FUNCTION
	Selects previous display screen in the same display group.
	Selects previous display group.
	Selects next display group.
	Selects next display screen in the same display group.
	When held pressed for 5 seconds, enters PROGRAMMING mode.

## 6.3. LED FUNCTIONS

**POWER:** Turns on as long as energy is supplied to the unit.



**COMM:** Flashes when the RS-485 Modbus communication is active.

**ALARM:** Turns on in case of high level alarm (trip condition).

**UYARI:** Turns on in case of warning.



## 6.4. SCREEN SCROLLING

The unit performs a detailed set of AC measurements. Displaying these parameters are organized under PARAMETER GROUPS and subgroups.

Switching between parameter groups are made with  and  buttons.

Each depression of the  button switches the screen to the next parameter group. After the last group, the first group is displayed again.

Each depression of the  button switches the screen to the previous parameter group. After the first group, the last group is displayed again.

Switching within the same group is performed with  and  buttons.

Each depression of the  button switches the screen to the next display in the same group. After the last display, the first display comes again.

Each depression of the  button switches the screen to the previous display in the same group. After the first display, the last display comes again.

The list of **parameter groups** are below:

**Channel Measurement Screens:** Voltage, current, kW, kVA, kVAr, pf and reactive ratio of each input channel.

**Channel Counter Screens:** Instantaneous current, demand current, demand power, active and reactive energy counters of each input channel.

**Main busbar voltages and frequency:** Phase-neutral, phase-phase and average voltages of the main busbar in different screens.

**GSM Modem Parameters:** Signal level, counters, connection status, IP addresses, etc...

**Status Group:** Various information as date-time, firmware version, identity, configuration, etc...

**User Screens:** Screens in this group are configured by the user.

**Oscilloscope Screen:** In this group, waveforms of currents and voltages may be visualized as an oscilloscope. All phase-neutral and phase-phase voltages and each current input are available. Thanks to this feature, waveform distortions and harmonic components are displayed in graphical form.

**Harmonic Analysis Result Tables:** In this group, THDs of currents and voltages are displayed with 0.1% precision. All phase-neutral and phase-phase voltages and each current input are available.

## 7. WAVEFORM DISPLAY & HARMONIC ANALYSIS

The unit features waveform display together with a precision harmonic analyzer for both voltages and currents. Both phase to neutral and phase to phase voltages are available for analysis, thus 36 channels in total are possible.

**Available channels are:**

Main busbar volts: V1, V2, V3, U12, U23, U31

Currents: I1, I2, I3, ..., I29, I30

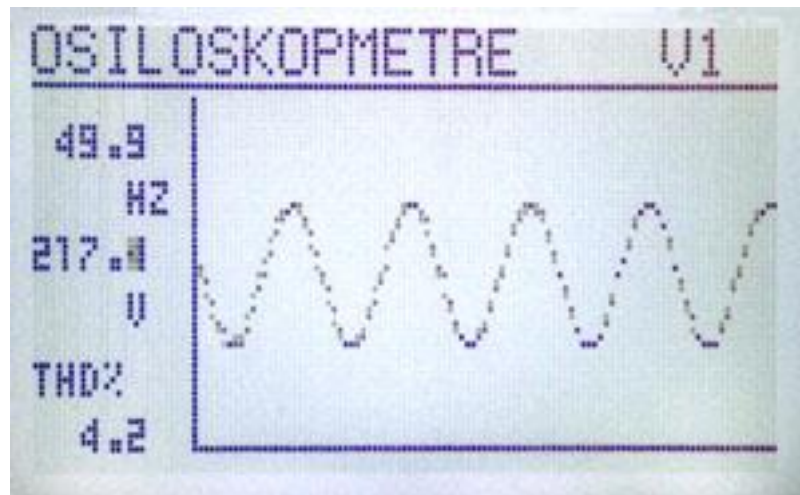



*Scopemeter Display*

The waveform display memory is of 100 samples length and 13 bit resolution, with a sampling rate of 2048 s/s. Thus one cycle of a 50Hz signal is represented with 41 points. The vertical scale is automatically adjusted in order to avoid clipping of the signal.

The waveform is displayed on the device screen, and with more resolution on PC screen through the RainbowPlus program.

The display memory is also available in the Modbus register area for third party applications. For more details please check chapter "**MODBUS Communications**".

The waveform display is updated twice a second. All channels may be scrolled using   buttons.

The harmonic analyzer consists on a Fast Fourier Transform (FFT) algorithm which is run twice a second on the selected channel.

The sample memory is 1024 samples length and 13 bits resolution with a sampling rate of 2048 s/s.

The unit is able to analyze up to 900Hz and up to 17th harmonic, whichever is smaller.

LINE	THD:	3.9	H10:	0.1
V1	H03:	2.6	H11:	0.0
49.9	H04:	0.1	H12:	0.2
H2	H05:	2.0	H13:	0.2
	H06:	0.3	H14:	0.5
218.6	H07:	0.5	H15:	0.1
U	H08:	0.3	H16:	1.1
	H09:	0.5	H17:	0.9

**Alphanumeric Harmonics Table**

All harmonics are displayed with 0.1% resolution.

On RainbowPlus program, harmonics and waveform are displayed on a single screen with more resolution.

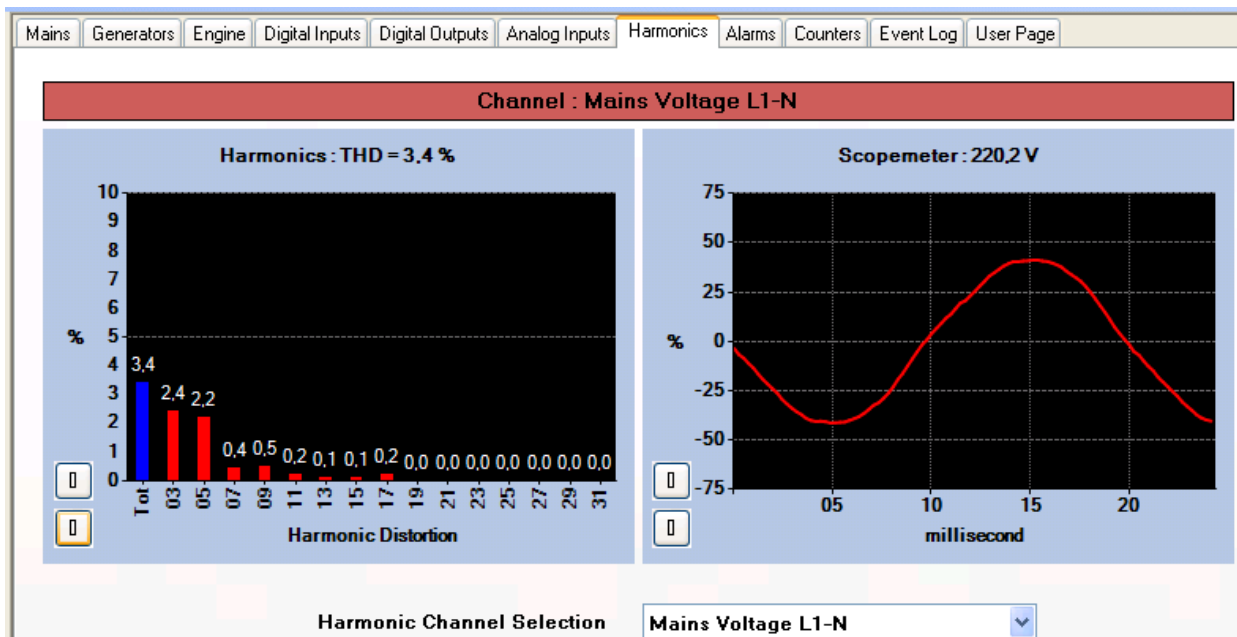

**RainbowPlus Scada section: Harmonic Analysis and Waveform Display**

## 8. ASTRONOMIC RELAY FUNCTIONALITY

Thanks to its internal astronomical relay function, the unit calculates sunrise and sunset times with precision using geographical coordinates and date.

Using the astronomical relay function it is possible turn on/off lights and activate various equipment depending on sunrise and sunset.



*Astronomical relay display screen*

Astronomical relay parameter setting is performed through LOCATION SETUP group of the programming menu.

The date-time information is picked-up from the internal real time clock circuit.

Geographical position information is programmed by direct entry of latitude and longitude.

The unit is capable of activating a relay following sunrise and sunset times. The delay before sunrise and the delay after sunset are programmable.

## 9. PROTECTIONS AND ALARMS

Measured analog values outside of programmed limits cause an ALARM condition.

Alarms cause below, actions to be taken:

- The **ALARM** led to turn on steadily,
- The **Alarm** digital output to operate.



**If a fault condition occurs, the display will automatically switch to the ALARM LIST page.**

### Alarms operate in a first occurring basis:

-If an alarm is present, following alarms will not be accepted,

Alarms may be of **LATCHING** type following programming. For latching alarms, even if the alarm condition is removed, the alarms will stay on and disable the operation of the genset.

Most alarms have programmable trip levels. See the programming chapter for adjustable alarm limits.

## 10. PROGRAMMING



The program mode is used to adjust timers, operational limits and the configuration of the unit.

Although a free PC program is provided for programming, every parameter may be modified through the front panel, regardless of the operating mode.

When modified, program parameters are automatically recorded into a non-erasable memory and take effect immediately.

The program mode will not affect the operation of the unit. Thus programs may be modified anytime.





### 10.1. ENTERING THE PROGRAMMING MODE

To **enter the program mode**, press together ,  and  buttons for 5 seconds.

When the program mode is entered, below password entry screen will be displayed.



A 4 digit password must be entered using , , ,  buttons.

The ,  buttons modify the value of the current digit. The ,  buttons navigate between digits.

The unit supports 3 password levels. The level\_1 is designed for field adjustable parameters. The level\_2 is designed for factory adjustable parameters. The level\_3 is reserved. It allows recalibration of the unit.

The password level-1 is factory set to '1234' and the password level-2 is factory set to '9876'.







**Passwords are not front panel adjustable.**

If a wrong password is entered, the unit will still allow access to the program parameters, but in read-only mode.







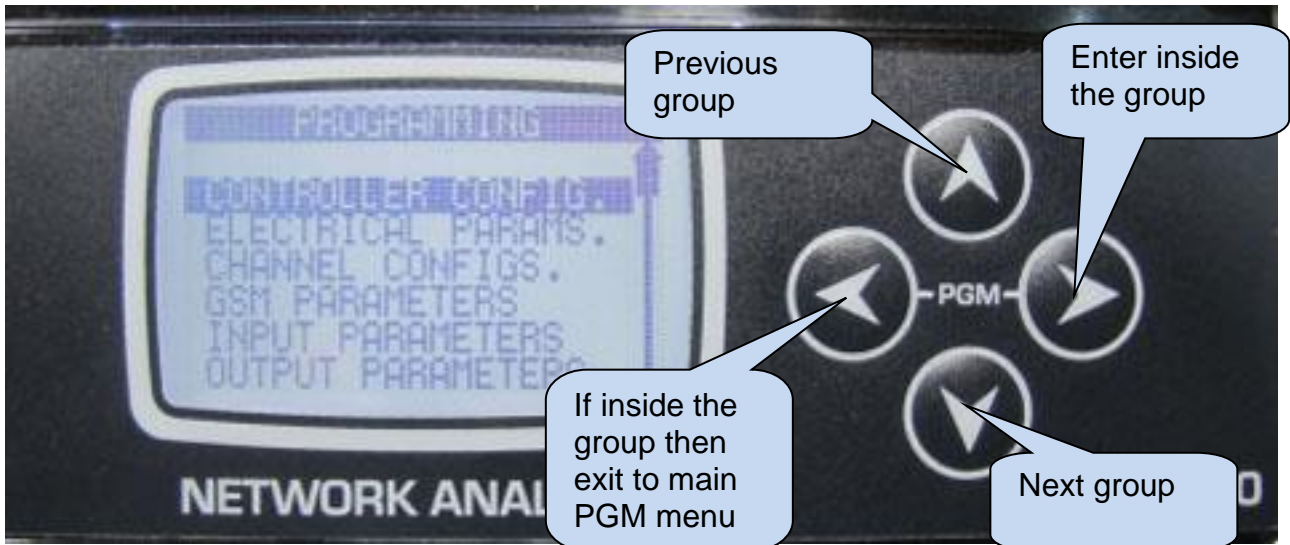

## 10.2. NAVIGATING BETWEEN MENUS

The program mode is driven with a two level menu system. The top menu consists on program groups and each group consists on various program parameters.

When program mode is entered, a list of available groups will be displayed. Navigation between different groups are made with  and  buttons. Selected group is shown in reverse video (black on white). In order to enter inside a group, please press  button. In order to exit from the group to the main list please press  button.



Navigation inside a group is made also with  and  buttons. A list of available parameters will be displayed. Selected parameter is shown in reverse video (black on white). In order display/change the value of this parameter, please press  button. Parameter value may be increased and decreased with  and  buttons. If these keys are hold pressed, the program value will be increased/decreased by steps of 10. When a program parameter is modified, it is automatically saved in memory. If  button is pressed, next parameter will be displayed. If  button is pressed, then the list of parameters in this group will be displayed.

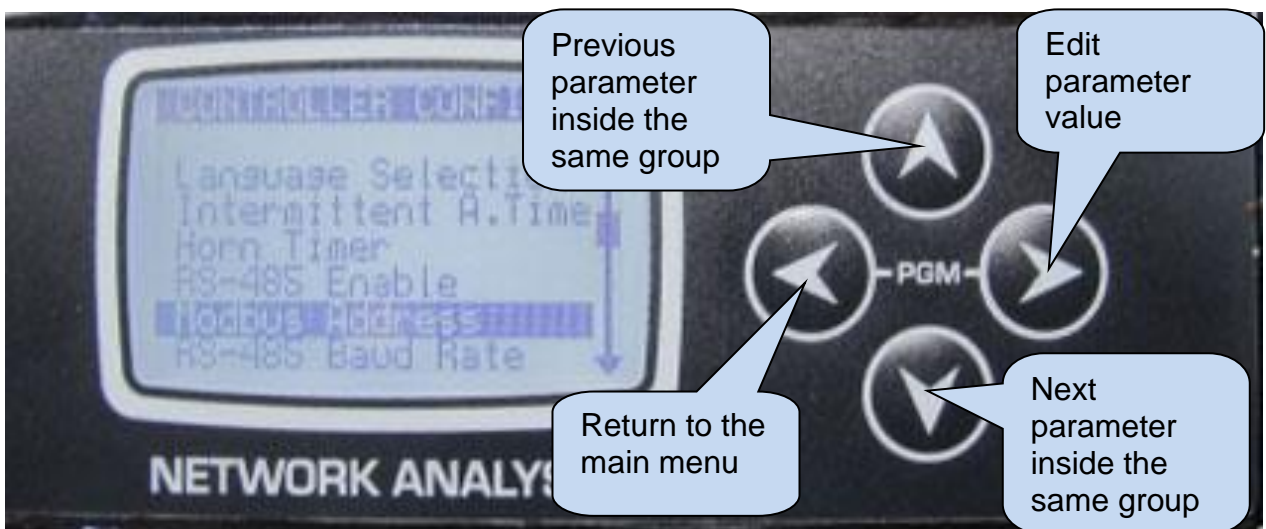

### 10.3. MODIFYING PARAMETER VALUE

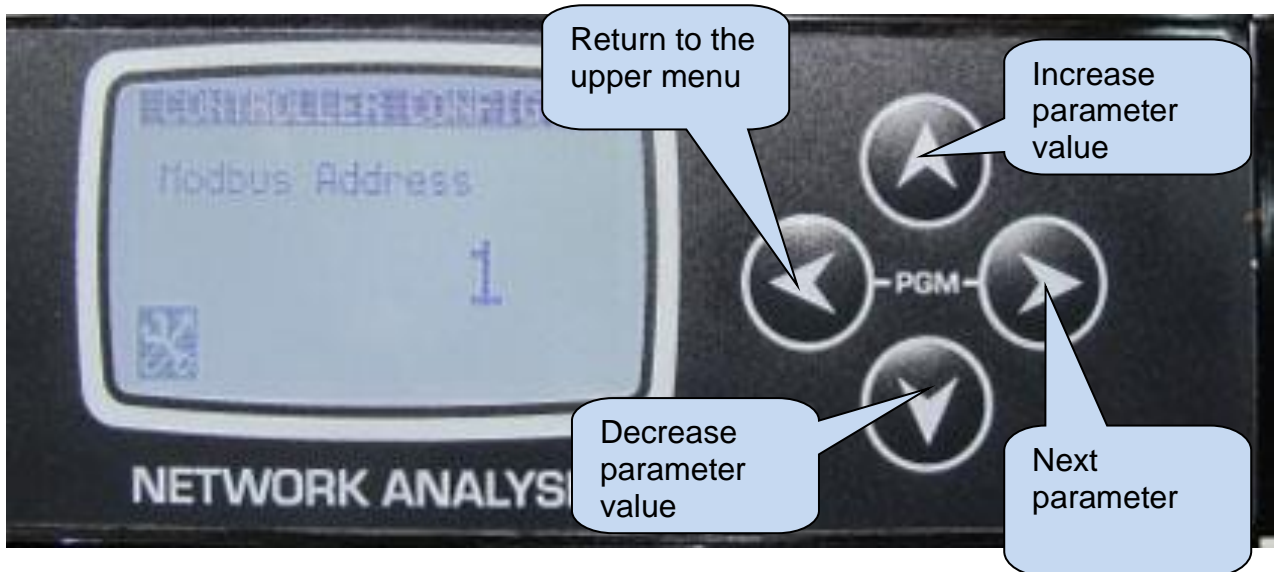

### 10.4. PROGRAMMING MODE EXIT

To **exit the program mode** press one of the mode selection keys. If no button is pressed during 2 minutes the program mode will be cancelled automatically.

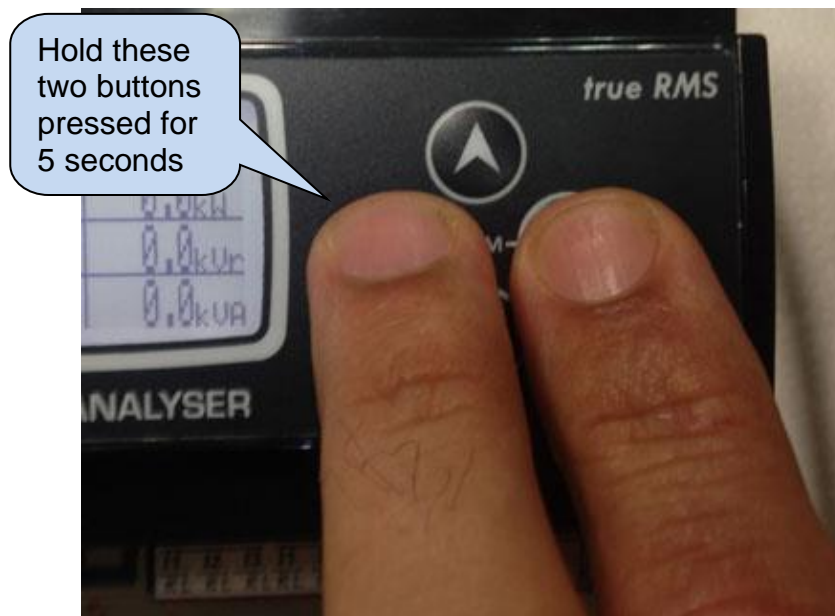

## 11. PROGRAM PARAMETER LIST

### 11.1. CONTROLLER CONFIGURATION GROUP

Parameter Definition	Unit	Min	Max	Factory Set	Description
LCD Contrast	-	30	50	39	This parameter is used to set LCD contrast. Adjust for the best viewing angle.
Language	-	0	1	0	0: English language selected. 1: Local language selected. This language may depend on the country where the unit is intended to be used.
Intermittent Alarm Timer	sec	0	250	60	If Intermittent Relay parameter is 1, then the HORN relay is activated and deactivated with this period.
Horn Timer	sec	0	120	60	This is the period during which the HORN relay is active. If the period is set to 0, this will mean that the period is unlimited.
RS-485 Enable	-	0	1	1	0: RS-485 port disabled 1: RS-485 port enabled
Modbus Address	-	0	240	1	This is the modbus controller identity used in Modbus communication.
RS-485 Baud Rate	bps	2400	115200	9600	This is the data rate of the RS-485 Modbus port.
Intermittent Alarm Relay	-	0	1	0	0: continuous 1: intermittent
LCD Backlight Delay	min	0	1440	60	If no button is pressed during this period, then the unit will reduce the LCD screen backlight intensity in for economy.
Flashing Relay ON Timer	min	0	1200	0	Flashing relay ON state duration timer.
Flashing Relay OFF Timer	min	0	1200	0	Flashing relay OFF state duration.
Internal Record Timer	sec	2	3600	900	Defines the data recording period to internal memory. Shorter periods will cause the internal memory to roll-up more often.

## 11.2. ELECTRICAL PARAMETERS GROUP

Parameter Definition	Unit	Min	Max	Factory Set	Description
Current Transformer Primary	Amp	1	5000	500	This is the rated value of current transformers. All transformers must have the same rating. The secondary of the transformer will be 0.1 Amps.
Voltage Transformer Ratio	-	0	5000	1.0	This is the voltage transformer ratio. This value will multiply all voltage and power readings. If transformers are not used, the ratio should be set to 1.0
Alarm Mute Timer	sec	0	10	1	If the alarm is selected <b>non-latching</b> , then the alarm condition disappears this timer after the alarm signal goes off.
Mains Phase Order Check Enable	-	0	1	0	0: mains phase order checking disabled 1: if mains phase order is faulty, then an alarm occurs.
Low Voltage Alarm Limit	V	0	65000	0	If the voltage of any phase falls below this limit, this will cause an alarm. If this limit is 0 then low voltage alarm is not controlled.
High Voltage Alarm Limit	V	0	65000	0	If the voltage of any phase goes above this limit, this will cause an alarm. If this limit is 0 then high voltage alarm is not controlled.
Voltage Fail Timer	sec	0	255	1	If the voltage goes outside limits during this timer, a voltage alarm will occur.
Voltage Alarm Lock Enable	-	0	1	1	0: alarm non latching 1: latching alarm
Frequency Low Alarm	Hz	0	400	0	If the frequency goes under this limit, this will cause an alarm. If this limit is 0 then the alarm is not controlled.
Frequency High Alarm	Hz	0	400	0	If the frequency goes above this limit, this will cause an alarm. If this limit is 0 then the alarm is not controlled.
Frequency Alarm Duration	sec	0	255	1	If the frequency goes outside of the limits during this timer, a frequency alarm will occur.
Frequency Alarm Lock Enable	-	0	1	1	0: alarm non latching 1: latching alarm
Active Power Low Alarm	kW	0	400	0	If the active power of any channel goes under this limit, this will cause an alarm. If this limit is 0 then the alarm is not controlled.
Active Power High Alarm	kW	0	400	0	If the active power of any channel goes above this limit, this will cause an alarm. If this limit is 0 then the alarm is not controlled.
Active Power Alarm Duration	sec	0	255	1	If the active power of any channel goes outside of the limits during this timer, an active power alarm will occur.
Active Power Alarm Lock Enable	-	0	1	1	0: alarm non latching 1: latching alarm

## 11.2. ELECTRICAL PARAMETERS GROUP (continued)

Parameter Definition	Unit	Min	Max	Factory Set	Description
Reactive Power Capacitive Alarm	kVAr	0	400	0	If the reactive power of any channel is capacitive and goes above this limit, this will cause an alarm. If this limit is 0 then the alarm is not controlled.
Reactive Power Inductive Alarm	kVAr	0	400	0	If the reactive power of any channel is inductive and goes above this limit, this will cause an alarm. If this limit is 0 then the alarm is not controlled.
Reactive Power Alarm Duration	sec	0	255	1	If the reactive power of any channel goes outside of the limits during this timer, a reactive power alarm will occur.
Reactive Power Alarm Lock Enable	-	0	1	1	0: alarm non latching 1: latching alarm
Power Factor Capacitive Alarm	-	0.000	1.000	0.000	If the power factor of any channel is capacitive and goes below this limit, this will cause an alarm. If this limit is 0 then the alarm is not controlled.
Power Factor Inductive Alarm	-	0.000	1.000	0.000	If the power factor of any channel is inductive and goes below this limit, this will cause an alarm. If this limit is 0 then the alarm is not controlled.
Power Factor Alarm Duration	sec	0	255	1	If the power factor of any channel goes outside of the limits during this timer, a power factor alarm will occur.
Power Factor Alarm Lock Enable	-	0	1	1	0: alarm non latching 1: latching alarm
Current High Alarm	A	0	5000	0	If the current of any channel goes above this limit, this will cause an alarm. If this limit is 0 then the alarm is not controlled.
Current High Alarm Duration	sec	0	255	1	If the current of any channel goes outside of the limits during this timer, a current alarm will occur.
Current Alarm Lock Enable	-	0	1	1	0: alarm non latching 1: latching alarm
THD-V Alarm	%	0	100	0	If the THD of any voltage goes above this limit, this will cause an alarm. If this limit is 0 then the alarm is not controlled.
THD-V Alarm Duration	sec	0	255	1	If the THD of any voltage goes outside of the limits during this timer, a THD-V alarm will occur.
THD-V Alarm Lock Enable	-	0	1	1	0: alarm non latching 1: latching alarm

## 11.2. ELECTRICAL PARAMETERS GROUP (continued)

THD-I Alarm	%	0	100	0	If the THD of any current channel goes above this limit, this will cause an alarm. If this limit is 0 then the alarm is not controlled.
THD-I Alarm Duration	sec	0	255	1	If the THD of any current channel goes outside of the limits during this timer, a THD-I alarm will occur.
THD-I Alarm Lock Enable	-	0	1	1	0: alarm non latching 1: latching alarm
Voltage Unbalance Alarm	%	0	100	0	If the Voltage Unbalance goes above this limit, this will cause an alarm. If this limit is 0 then the alarm is not controlled.
Voltage Unbalance Alarm Duration	sec	0	255	1	If the Voltage Unbalance goes outside of the limits during this timer, a THD-I alarm will occur.
Voltage Unbalance Alarm Lock Enable	-	0	1	1	0: alarm non latching 1: latching alarm
Demand Interval	min	0	1000	15	This is the period used in demand calculations.
Counter Unit	-	0	1	1	0: kWh 1: MWh



## 11.3. CHANNEL CONFIGURATION

In this group, every current channel is adjusted independently and assigned to any analyzer unit.

A general CT ratio is provided for the ease of configuration. If the related channel's CT parameter is left 0, then the general CT ratio is used. Each channel's CT ratio may also be independently adjusted.

Each current input can be matched to any voltage phase. CT inputs may be reversed.

## 11.4. GSM MODEM PARAMETERS

Parameter Definition	Unit	Min	Max	Factory Set	Description
Modem Selection	-	0	4	0	<b>0:</b> not used <b>1:</b> Internal GSM modem
GPRS Connection Enable	-	0	1	0	<b>0:</b> GPRS disabled <b>1:</b> GPRS enabled
Ping Period	sec	30	900	120	The unit will check the availability of the internet connection with this interval.
Modbus over IP Port	-	0000	65535	502	Internal Modbus TCP/IP server port. The unit answers only queries coming from this port number.
Site ID	The site identity string is designed to identify the current controller. This is the site Id string sent at the beginning of SMS messages, e-mails and web page headers for the identification of the genset sending the message. Any 20 character long string may be entered.				
Serial Number	The engine serial number string is designed to identify the current controller. This string is added to GSM-SMS messages, e-mails, web page headers etc... Any 20 character long string may be entered.				
SMS Enable	-	0	1	0	<b>0:</b> SMS messages disabled <b>1:</b> SMS messages enabled
SMS on Output Change	-	0	1	0	<b>0:</b> no SMS on any output relay change <b>1:</b> SMS sent on output relay change.
SMS on IP Change	-	0	1	0	This parameter controls SMS sending when IP address of GPRS connection is changed. No warnings generated. <b>0:</b> no SMS on IP change <b>1:</b> SMS sent on IP change
SMS Commands Enabled	-	0	1	0	<b>0:</b> SMS commands not accepted <b>1:</b> SMS commands are accepted but from listed telephone numbers only.
SMS Phone Numbers	These telephone number buffers accept up to 16 digits and are used for SMS sending.				
E-mail server port	-	0000	65535	587	Server port used in e-mail sending.
E-mail on IP Change	-	0	1	0	This parameter controls e-mail sending when IP address of GPRS or ethernet connection is changed. No warnings generated. <b>0:</b> no e-mail on IP change <b>1:</b> e-mail sent on IP change

## 11.4. GSM MODEM PARAMETERS (continued)

Parameter Definition	Unit	Min	Max	Factory Set	Description
E-mail account name	-----@yahoo.com				When the unit sends e-mails to users, this string will appear at the sender domain.
E-mail Account Password	d500_1234				The password for the e-mail account should be written to this parameter.
E-posta Sunucu Adı	smtp.mail.yahoo.com				Kullanılan mail hesabının ait olduğu mail server adresi bu parametreye tanımlanmalıdır.
E-mail Adresi-1 E-mail Adresi-2 E-mail Adresi-3	- - -				The unit is capable of sending e-mails to 3 different addresses.
Rainbow Scada Refresh Rate	sec	0	65535	5	The unit will update the distant monitoring terminal with this rate.
Rainbow Scada Address-1 Port	-	0	65535	0	This is the port number of the first monitoring terminal address.
Rainbow Scada Address-2 Port	-	0	65535	0	This is the port number of the second monitoring terminal address.
Ping Address	www.google.com				In order to check internet connection availability, the unit will periodically "ping" this address.
APN User Name	The APN (access point name) username may be required by the GSM operator. However some GSM operators may allow access without username. The exact information should be obtained from the GSM operator. Please search the GSM operator's website with "APN" string.				
APN Password	If the APN (access point name) username is required by the GSM operator, most probably the APN password will also be required. However some GSM operators may allow access without password. The exact information should be obtained from the GSM operator. Please search the GSM operator's website with "APN" string.				
APN Name	The APN (access point name) is always required by the GSM operator. The exact information should be obtained from the GSM operator. Please search the GSM operator's website with "APN" string.				
SMS Service Center Number	The SMS service center number may be required by the GSM operator. However some GSM operators may allow SMS sending without SMS service center number. The exact information should be obtained from the GSM operator. Please search the GSM operator's website with "sms service center" string.				



**Please enter phone numbers starting from the first character. Do not leave any blanks.**



## 11.5. DIGITAL INPUT PARAMETERS

The unit has 2 digital inputs. Only parameters of one input are explained below. Other input have identical parameter set.

The input name is freely programmable, thus the input can be adapted to any functionality through programming.



**The input name entry is made through RainbowPlus program only.**

Each digital input has below programmable parameters:

Parameter Definition	Unit	Min	Max	Factory Set	Description
Input Function	-	0	99		Selects between predefined input functions. Selected input name is displayed in the line below. If this parameter is set to 0 then the input name string can be freely entered. <b>0:</b> User function-1 <b>1:</b> User function-2 <b>2:</b> Alarm Mute <b>3:</b> High Temperature <b>4:</b> Panel Lock
Action	-	0	3		<b>0:</b> alarm
Sampling	-	0	3		<b>0:</b> always
Latching	-	0	1		<b>0:</b> non-latching. The fault disappears when cause is removed. <b>1:</b> latching. The fault persists even if the cause is removed. Requires manual reset.
Contact type	-	0	1		<b>0:</b> Normally open <b>1:</b> Normally closed
Response delay	-	0.1	10		This is the delay between the fault signal comes and the alarm occurs.

## 11.6. DIGITAL OUTPUT PARAMETERS

The parameters below define the functions of relay outputs. The unit has 2 relay outputs. All relays have programmable functions, selected from a list.



**Below is a short list for reference purposes. Please use the RainbowPlus program for complete selection list.**

### OUTPUT FUNCTION LIST

No	Description	No	Description	No	Description
1	Horn	31	Currentunbalance Alarm		
2	Flashing relay	32	Unbalance alarm		
3	Phase order alarm	33	User input alarm-1		
4	Voltage alarm	34	User input alarm-2		
5	Voltages OK	35	Button 1 simulation		
6	Internal alarm	36	Button 2 simulation		
7	Input alarm	37	Button 3 simulation		
8	Warning	38	Button 4 simulation		
9	Internal input alarm	39	Input-1 simulation		
10	kWh tick	40	Input-2 simulation		
11	kVArh tick	41	User output 1		
12	Low voltage alarm	42	User output 2		
13	High voltage alarm	43	Astronomical relay		
14	Low frequency alarm	44			
15	High frequency alarm	45			
16	Frequency alarm	46			
17	Low kW alarm	47			
18	High kW alarm	48			
19	kW alarm	49			
20	kVAr Capacitive alarm	50			
21	kVAr inductive alarm	51			
22	kVAr alarm	52			
23	Pf capacitive alarm	53			
24	Pf inductive alarm	54			
25	Pf alarm	55			
26	High current alarm	56			
27	THD-V alarm	57			
28	THD-I alarm	58			
29	THD alarm	59			
30	Voltage Unbalance A.	60			

## 11.7. USER INPUT SCREENS

In this group various texts are entered. These texts appear at top of user screens, as special names for digital inputs or analyzer module names.

## 11.8. DEMAND AND COUNTERS





In this group, restarting of demand periods and counter value settings are performed.

## 11.9. USER SCREENS

4 available user defined screens are configured through this menu.



There are 2 different character sizes that can be selected. (5x7 and 10x14 pixels)

- 1) Please select character size with  and  buttons, then press .
- 2) Please select the value to display through "SELECT AN ITEM" menu, then press .

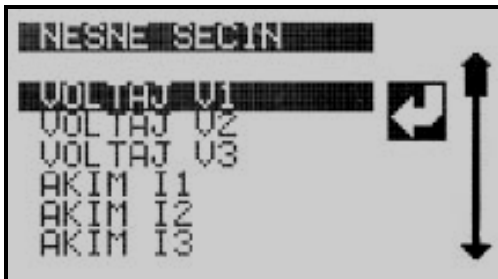

For the next item to display, the menu returns to the character size selection menu. Above steps 1 and 2 may be repeated until the screen is full.

As long as the user stays in the user screen menu, the current appearance of the screen will be on display.

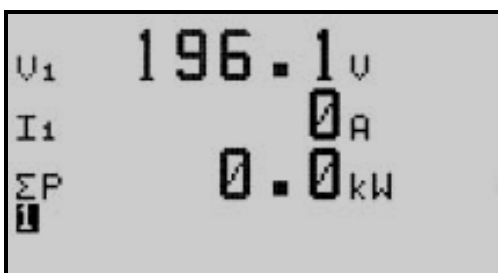

When all available space is occupied, the menu is automatically exited.

If required, the menu may be exited without filling the screen by holding  button pressed for 3 seconds.

## 11.10. DEVICE CALIBRATION

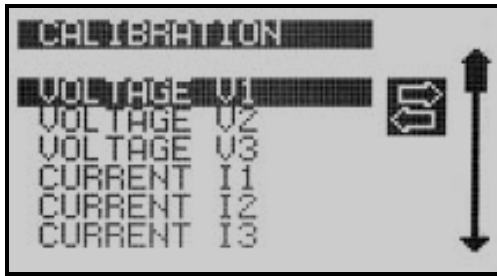

The unit is calibrated during factory production, but it is possible to calibrate again.

Please select "DEVICE CALIBRATION" menu from PROGRAMMING section.

Then select the input with and buttons and press .

Then adjust the coefficient in order to display the correct measured value on the screen and press button in order to save the new calibration and return to PROGRAMMING section.



MEASURED  
VALUE

## 11.11. ADJUST DATE AND TIME

These parameters allow adjusting the battery backup real time clock of the module. Once set, the clock will continue to run even if supply power is removed from the unit.

Parameter	Definition	Unit	Min	Max	Description
Date		-	01	31	Current day of the month.
Month		-	01	12	Current month.
Year		-	00	99	Last two digits of the current year.
Hours		-	00	23	Current hour of the day.
Minutes		-	00	59	Current minute of the hour.
Seconds		-	00	59	Current second of the minute.

## 11.12. CHANGE PASSWORD



The unit has 3 different password levels. Each password consists on a 4 digit number.



**Passwords can only be modified at factory.**

## 11.13. RETURN TO FACTORY SETTINGS

When this menu is selected, the unit will ask for confirmation.

Please adjust required selection with  and  buttons, then press  in order to return to PROGRAMMING section.



**It is not possible to restore previous parameter settings.**

## 11.14. LOCATION SETUP

Parameters adjusted in this section are used in the astronomical relay function.

Parameter Definition	Unit	Min	Max	Factory Set	Description
TIME SOURCE	-	-	-	RTC	The unit picks up the date&time information only from the internal RTC.
LOCATION SOURCE	-	-	-	SET	This parameter determines the source for geographical location information. The unit supports only manual entry.
LATITUDE	degrees	66S	66N	41,000N	This parameter defines the latitude as degrees. <b>NOTE:</b> Sunrise and sunset cannot be calculated for latitudes beyon polar circles.
LONGITUDE	degrees	180W	180E	36,444E	This parameter defines the longitude in degrees.
TIME ZONE	hour	-12	+12	+2	The effective time zone. For eastern longitudes the sign is positive. For western longitudes the sign is negative. Central Europe is generally +1 time zone.
SUNRISE OFFSET	minute			30	Defines the delay before sunrise that the astronomical relay will turn off.
SUNSET OFFSET	minute			30	Defines the delay after sunset that the astronomical relay will turn on.
PLATE CODE	-	1	100	34	Available for Turkey only. Latitudes and longitudes may be automatically selected from list.

## 12. INTERNAL RECORD MEMORY

The 1MB internal memory of the unit holds 200 records of 512 bytes long.

The record period is adjusted by program parameter.

Records can only be read through Modbus.

## 13. CENTRAL MONITORING OF UNITS

Please see related document: **Rainbow Scada Usage Guide**.

## 14. E-MAIL SENDING

Please see related document: **Ethernet Configuration Guide for D-500 D-700**.

## 15. SMS COMMANDS



SMS messages are accepted only from phone numbers recorded in the **GSM PARAMETERS>SMS TEL NUMBERS** tab.

Answers to SMS messages will be sent to **all** phone numbers in the list.



SMS messages must be written exactly as below, without any preceding blanks. Only **UPPERCASE** characters are permitted.

COMMAND	DESCRIPTION	ANSWER
<b>GET IP</b>	If GPRS connection is active, the controller will reply by an SMS message indicating the IP address of the GSM modem.	<b>IP: 188.41.10.244</b>
<b>GPRS 1</b>	Activates the GPRS connection	<b>GPRS enabled!</b>
<b>GPRS 0</b>	Stops the GPRS connection	<b>GPRS disabled!</b>
<b>RESET ALARMS</b>	Clears alarms of the controller. The operating mode is not modified.	<b>Alarms cleared!</b>
<b>REBOOT</b>	Performs a hard reset on the controller	no answer
<b>MODEM RESET</b>	Performs a hard reset on the modem	no answer

## 16. MODBUS COMMUNICATIONS

The unit offers the possibility of MODBUS communication through below carriers:

- RS485 serial port, with adjustable baud rate between 2400 and 115200 bauds
- MODBUS-TCP/IP through GPRS (85/85kb), client mode through Rainbow Scada only

The MODBUS properties of the unit are:

- Data transfer mode: RTU
- Serial data: selectable baud rate, 8 bit data, no parity, 1 bit stop
- Modbus-TCP/IP: GPRS Class 12.
- Supported functions:
  - Function 3 (Read multiple registers)
  - Function 6 (Write single register)
  - Function 16 (Write multiple registers)

Each register consists of 2 bytes (16 bits). A larger data structure will contain multiple registers.

The Modbus communications requires a slave address to be assigned to each device in the Modbus network. This address ranges between 1 and 240 and allows the addressing of different slave devices in the same network.



**Each device in the same RS-485 serial network must be assigned a different slave address. Otherwise the Modbus communications will not be performed.**



**Devices using Modbus-TCP/IP with different IP or port addresses may use any slave address. It is advised to set these slave addresses to the default setting which is 1.**

### 16.1. PARAMETERS REQUIRED FOR RS-485 MODBUS OPERATION

**Modbus Slave Address:** may be set between 1 and 240

**RS-485 Enable:** must be set to 1 (or checkbox enabled)

**RS-485 Baud Rate:** selectable between 2400 and 115200 bauds. All devices in the same network must use the same Baud Rate.

Selecting a higher baud rate will allow faster communication, but will reduce the communication distance. Selecting a lower baud rate will increase the communication distance, but will cause slower response times. Typically 9600 bauds will allow 1200m distance with special balanced 120 ohms cable.

### 16.2. DATA FORMATS

**16bit variables:** These variables are stored in a single register. Bit\_0 denotes the LSB and bit 15 denotes the MSB.

**32 bit variables:** These variables are stored in 2 consecutive registers. The high order 16 bits are in the first register and the low order 16 bits are in the second register

**Bit arrays:** Arrays larger than 16 bits are stored in multiple registers. The LSB of the first register is bit\_0. The MSB of the first register is bit\_15. The LSB of the second register is bit\_16. The MSB of the second register is bit\_31, and so on.

### 16.3. EXCHANGE BUFFER

Large blocks of information are transferred to other systems in smaller parts through this area. For example, the record memory of the unit is read through the exchange buffer in parts.

ADDRESS (decimal)	R / W	DATA SIZE	COEFF.	DESCRIPTION
4096-4611	R/W	16bit	-	Exchange buffer (516 registers)

### 16.4. DATE-TIME AND LOCATION ARRAY

ADDRESS (decimal)	R / W	DATA SIZE	COEFF.	DESCRIPTION
8192	R / W	32bit	-	Year (0-4095)
8193	R / W	32bit	-	Month (1-12)
8194	R / W	32bit	-	Date (1-31)
8195	R / W	32bit	-	Day of Week (0-6)
8196	R / W	32bit	-	Hours (0-23)
8197	R / W	32bit	-	Minutes (0-59)
8198	R / W	32bit	-	Seconds (0-59)

ADDRESS (decimal)	R / W	DATA SIZE	COEFF.	DESCRIPTION
8192	R/W	16bit	-	Year (0-4095)
8193	R/W	16bit	-	Month (1-12)
8194	R/W	16bit	-	Date (1-31)
8195	R/W	16bit	-	Day of Week (0-6)
8196	R/W	16bit	-	Hours (0-23)
8197	R/W	16bit	-	Minutes (0-59)
8198	R/W	16bit	-	Seconds (0-59)
8199-8200	R/W	32bit	-	Latitude
8201-8202	R/W	32bit	-	Longitude
8203	R/W	16bit	-	Sunrise (hour, minute)
8204	R/W	16bit	-	Sunset (hour, minute)



## 16.5. COUNTERS ARRAY

This area contains energy counters and demand registers.

ADDRESS (decimal)	R / W	DATA SIZE	COEFF.	DESCRIPTION
12288	R/W	32bit	10	Input-01 active energy counter
12290	R/W	32bit	10	Input -02 active energy counter
.....	R/W	32bit	10	.....
.....	R/W	32bit	10	.....
12346	R/W	32bit	10	Input -30 active energy counter

ADDRESS (decimal)	R / W	DATA SIZE	COEFF.	DESCRIPTION
12348	R/W	32bit	10	Input -01 reactive energy counter
12350	R/W	32bit	10	Input -02 reactive energy counter
.....	R/W	32bit	10	.....
.....	R/W	32bit	10	.....
12406	R/W	32bit	10	Input -30 reactive energy counter

ADDRESS (decimal)	R / W	DATA SIZE	COEFF.	DESCRIPTION
12408	R/W	32bit	1	Demand Counter
12410	R/W	32bit	1	Demand period
12416	R/W	32bit	10	Input -01 current demand
12418	R/W	32bit	10	Input -02 current demand
.....	R/W	32bit	10	.....
.....	R/W	32bit	10	.....
12474	R/W	32bit	10	Input -30 current demand
12476	R/W	32bit	10	Input -01 active power demand
12478	R/W	32bit	10	Input -02 active power demand
.....	R/W	32bit	10	.....
.....	R/W	32bit	10	.....
12534	R/W	32bit	10	Input -30 active power demand

## 16.6. COMMAND ARRAY

Bu alan üzerinden cihaza çeşitli komutlar gönderilebilir.

ADDRESS (decimal)	R / W	DATA SIZE	COEFF.	DESCRIPTION
16385	W	16bit	-	Key press
16386	W	16bit	-	Return to factory settings
16387	W	16bit	-	Reset counters
16390	W	16bit	-	Go to boot mode
16391	W	16bit	-	Write to energy counter
16392	W	16bit	-	Reset demands
16401	W	16bit	-	Read SFM page
16402	W	16bit	-	Goto auto calibration
16403	W	16bit	-	Reset unit
16404	W	16bit	-	Oscilloscope channel number

## 16.7. MEASUREMENTS ARRAY

Modbus üzerinden okunabilen en önemli kayıtların listesi aşağıdadır.

ADDRESS (decimal)	R / W	DATA SIZE	COEFF.	DESCRIPTION
20480	R	32bit	x10	Phase L1 voltage
20482	R	32bit	x10	Phase L2 voltage
20484	R	32bit	x10	Phase L3 voltage
20486	R	32bit	x10	Phase L1-L2 voltage
20488	R	32bit	x10	Phase L2-L3 voltage
20490	R	32bit	x10	Phase L3-L1 voltage
20492	R	32bit	x10	Input-01 current
20494	R	32bit	x10	Input-02 current
.....	R	32bit	x10	.....
.....	R	32bit	x10	.....
20550	R	32bit	x10	Input-30 current
20552	R	32bit	x100	Input-01 active power (kW)
20554	R	32bit	x100	Input-02 active power (kW)
.....	R	32bit	x100	.....
.....	R	32bit	x100	.....
20610	R	32bit	x100	Input-30 active power (kW)
20612	R	32bit	x100	Input-01 reactive power (kVAr)
20614	R	32bit	x100	Input-02 reactive power (kVAr)
.....	R	32bit	x100	.....
.....	R	32bit	x100	.....
20670	R	32bit	x100	Input-30 reactive power (kVAr)
20672	R	32bit	x100	Input-01 apparent power (kVA)
20674	R	32bit	x100	Input-02 apparent power (kVA)
.....	R	32bit	x100	.....
.....	R	32bit	x100	.....
20730	R	32bit	x100	Input-30 apparent power (kVA)
20732	R	32bit	x10	Average Phase-Neutral voltage
20734	R	32bit	x10	Average Phase-Phase voltage
20736	R	16bit	x1000	Input-01 power factor (cos)
20737	R	16bit	x1000	Input-02 power factor (cos)
.....	R	16bit	x1000	.....
.....	R	16bit	x1000	.....
20765	R	16bit	x1000	Input-30 power factor (cos)
20766	R	16bit	x1000	Input-01 reactive power ratio(%)
20767	R	16bit	x1000	Input-02 reactive power ratio(%)
.....	R	16bit	x1000	.....
.....	R	16bit	x1000	.....
20795	R	16bit	x1000	Input-30 reactive power ratio(%)
20796	R	16bit	x100	Mains frequency
20797	R	16bit	x10	Internal supply voltage

## 16.8. ANALYZER BLOCKS

The unit offers 15 virtual analyzers. Any current input can be assigned to any analyzer block.

The sum of inputs assigned to an analyzer are displayed under this analyzer.

The definition of a sample analyzer block and starting addresses of each analyzer are given below. Each block is the copy of the sample block.

ADDRESS (decimal)	R / W	DATA SIZE	COEFF.	DESCRIPTION
20828	R	32bit	x10	Analyzer-01 I1 current (A)
20830	R	32bit	x10	Analyzer-01 I2 current (A)
20832	R	32bit	x10	Analyzer-01 I3 current (A)
20834	R	32bit	x10	Analyzer-01 total current (A)
20836	R	32bit	x100	Analyzer-01 total active power (kW)
20838	R	32bit	x100	Analyzer-01 total reactive power (kVAr)
20840	R	32bit	x100	Analyzer-01 total apparent power (kVA)
20842	R	16bit	x1000	Analyzer-01 total power factor (cos)
20843	R	16bit	x1000	Analyzer-01 total reactive power ratio (%)
20844	R	32bit	x10	Analyzer-02 I1 current (A)
.....	.....	.....	.....	.....
20859	R	16bit	x1000	Analyzer-02 total reactive power ratio (%)
20860	R	32bit	x10	Analyzer-03 I1 current (A)
.....	.....	.....	.....	.....
20875	R	16bit	x1000	Analyzer-03 total reactive power ratio (%)
20876	R	32bit	x10	Analyzer-04 I1 current (A)
.....	.....	.....	.....	.....
20891	R	16bit	x1000	Analyzer-04 total reactive power ratio (%)
20892	R	32bit	x10	Analyzer-05 I1 current (A)
.....	.....	.....	.....	.....
20907	R	16bit	x1000	Analyzer-05 total reactive power ratio (%)
20908	R	32bit	x10	Analyzer-06 I1 current (A)
.....	.....	.....	.....	.....
20923	R	16bit	x1000	Analyzer-06 total reactive power ratio (%)
20924	R	32bit	x10	Analyzer-07 I1 current (A)
.....	.....	.....	.....	.....
20939	R	16bit	x1000	Analyzer-07 total reactive power ratio (%)
20940	R	32bit	x10	Analyzer-08 I1 current (A)
.....	.....	.....	.....	.....
20955	R	16bit	x1000	Analyzer-08 total reactive power ratio (%)
20956	R	32bit	x10	Analyzer-09 I1 current (A)
.....	.....	.....	.....	.....
20971	R	16bit	x1000	Analyzer-09 total reactive power ratio (%)
20972	R	32bit	x10	Analyzer-10 I1 current (A)
.....	.....	.....	.....	.....
20987	R	16bit	x1000	Analyzer-10 total reactive power ratio (%)
20988	R	32bit	x10	Analyzer-11 I1 current (A)
.....	.....	.....	.....	.....
21003	R	16bit	x1000	Analyzer-11 total reactive power ratio (%)
21004	R	32bit	x10	Analyzer-12 I1 current (A)
.....	.....	.....	.....	.....
21019	R	16bit	x1000	Analyzer-12 total reactive power ratio (%)
21020	R	32bit	x10	Analyzer-13 I1 current (A)
.....	.....	.....	.....	.....
21035	R	16bit	x1000	Analyzer-13 total reactive power ratio (%)
21036	R	32bit	x10	Analyzer-14 I1 current (A)
.....	.....	.....	.....	.....
21051	R	16bit	x1000	Analyzer-14 total reactive power ratio (%)

ADDRESS (decimal)	R / W	DATA SIZE	COEFF.	DESCRIPTION
21052	R	32bit	x10	Analyzer-15 I1 current (A)
.....	.....	.....	.....	.....
21067	R	16bit	x1000	Analyzer-15 total reactive power ratio (%)

## 16.9. DIGITAL INPUTS AND OUTPUTS

ADDRESS (decimal)	R / W	DATA SIZE	COEFF.	DESCRIPTION
21068	R	16 bit	-	Dijital Input statuses (2 LSb bits)
21069	R	16 bit	-	Dijital output statuses (2 LSb bits)

## 16.10. HARMONIC ANALYSIS

The unit analyses harmonics of 30 current inputs and 6 voltage inputs. The harmonic analysis result buffer is identical for each channel.

The definition of a sample block and starting addresses of each block are given below. Each block is a copy of the sample block.

ADDRESS (decimal)	R / W	DATA SIZE	COEFF.	DESCRIPTION
+00	R	16bit	x100	Harmonic-02 percentage
+01	R	16bit	x100	Harmonic-03 percentage
+02	R	16bit	x100	Harmonic-04 percentage
+03	R	16bit	x100	Harmonic-05 percentage
+04	R	16bit	x100	Harmonic-06 percentage
+05	R	16bit	x100	Harmonic-07 percentage
+06	R	16bit	x100	Harmonic-08 percentage
+07	R	16bit	x100	Harmonic-09 percentage
+08	R	16bit	x100	Harmonic-10 percentage
+09	R	16bit	x100	Harmonic-11 percentage
+10	R	16bit	x100	Harmonic-12 percentage
+11	R	16bit	x100	Harmonic-13 percentage
+12	R	16bit	x100	Harmonic-14 percentage
+13	R	16bit	x100	Harmonic-15 percentage
+14	R	16bit	x100	Harmonic-16 percentage
+15	R	16bit	x100	Harmonic-17 percentage
+16	R	16 bit	-	Channel number
+17	R	16bit	x100	THD percentage

ADDRESS (decimal)	R / W	DATA SIZE	COEFF.	DESCRIPTION
21073	R	-	-	L1 voltage Harmonics
21091	R	-	-	L2 voltage Harmonics
21109	R	-	-	L3 voltage Harmonics
21127	R	-	-	U12 voltage Harmonics
21145	R	-	-	U23 voltage Harmonics
21163	R	-	-	U31 voltage Harmonics
21181	R	-	-	Current-01Harmonics
21199	R	-	-	Current-02 Harmonics
.....				.....
.....				.....
21703	R	-	-	Current-30 Harmonics

### 16.11. OSCILLOGRAPHIC RECORDS

The unit keeps waveforms of 30 current channels and 6 voltage channels.

The required channel number should be written to **"COMMAND ARRAY>Oscilloscope Channel Number"**.

ADDRESS (decimal)	R / W	DATA SIZE	COEFF.	DESCRIPTION
21721	R	16 bit	-	Oscilloscope channel (0-5:voltages, 6-35:Currents)
21722-21821	R	100x16bit	-	Oscilloscope point value (16 bit signed integer). Each register gives the value of a point on the X axis. The graphic is represented by a total number of 100 points.

### 16.12. DEVICE INFORMATION

ADDRESS (decimal)	R / W	DATA SIZE	COEFF.	DESCRIPTION
21830	R	16 bit	-	Device type (always 0x0430)
21831	R	16 bit	-	Firmware version

### 16.13. ALARM INFORMATION

ADDRESS (decimal)	R / W	DATA SIZE	COEFF.	DESCRIPTION
22351	R	32 bit	-	Bit_00: high voltage alarm Bit_01: low voltage alarm Bit_02: high frequency alarm Bit_03: low frequency alarm Bit_04: high THD-V alarm Bit_05: voltage unbalance alarm Bit_06: Phase order alarm Bit_07: digital Input-1 alarm Bit_08: digital Input-2 alarm Bit_09: panel alarm Bit_10: high temperature alarm Bit_11..31: -
22353	R	32 bit	-	Bit_00: Input-01 high active power alarm Bit_01: Input-02 high active power alarm Bit_02: ... Bit_03: ... Bit_29: Input-30 high active power alarm Bit_30-31: -
22355	R	32 bit	-	Bit_00: Input-01 low active power alarm Bit_01: Input-02 low active power alarm Bit_02: ... Bit_03: ... Bit_29: Input-30 low active power alarm Bit_30-31: -

ADDRESS (decimal)	R / W	DATA SIZE	COEFF.	DESCRIPTION
22357	R	32 bit	-	Bit_00: Input-01 high reactive power alarm Bit_01: Input-02 high reactive power alarm Bit_02: ... Bit_03: ... Bit_29: Input-30 high reactive power alarm Bit_30-31: -
22359	R	32 bit	-	Bit_00: Input-01 low reactive power alarm Bit_01: Input-02 low reactive power alarm Bit_02: ... Bit_03: ... Bit_29: Input-30 low reactive power alarm Bit_30-31: -
22361	R	32 bit	-	Bit_00: Input-01 inductive cos alarm Bit_01: Input-02 inductive cos alarm Bit_02: ... Bit_03: ... Bit_29: Input-30 inductive cos alarm Bit_30-31: -
22363	R	32 bit	-	Bit_00: Input-01 capacitive cos alarm Bit_01: Input-02 capacitive cos alarm Bit_02: ... Bit_03: ... Bit_29: Input-30 capacitivecos alarm Bit_30-31: -
22365	R	32 bit	-	Bit_00: Input-01 high Current alarm Bit_01: Input-02 high Current alarm Bit_02: ... Bit_03: ... Bit_29: Input-30 high Current alarm Bit_30-31: -
22367	R	32 bit	-	Bit_00: Input-01 high THD-I alarm Bit_01: Input-02 high THD-I alarm Bit_02: ... Bit_03: ... Bit_29: Input-30 high THD-I alarm Bit_30-31: -

## 17. DECLARATION OF CONFORMITY

The unit conforms to the EU directives  
-2006/95/EC (low voltage)  
-2004/108/EC (electro-magnetic compatibility)

Norms of reference:  
EN 61010 (safety requirements)  
EN 61326 (EMC requirements)

The CE mark indicates that this product complies with the European requirements for safety, health environmental and customer protection.

### UL / CSA Conformity:

certification testing in progress  
UL 508, Edition 17  
UL 2200, 1st Edition.  
UL 840 Edition 3  
CSA C22.2 NO. 14 - Edition 10

## 18. MAINTENANCE



**DO NOT OPEN THE UNIT !**  
**There are NO serviceable parts inside the unit.**

Wipe the unit, if necessary with a soft damp cloth. Do not use chemical agents

## 19. DISPOSAL OF THE UNIT

Following **DIRECTIVE 2002/96/EC OF THE EUROPEAN PARLIAMENT AND OF THE COUNCIL of 27 January 2003 on waste electrical and electronic equipment (WEEE)**, this unit should be stored and disposed separately from the usual waste.

## 20. ROHS COMPLIANCE

The european ROHS directive restricts and prohibits the use of some chemical materials in electronic devices.

Following the “**DIRECTIVE 2011/65/EU OF THE EUROPEAN PARLIAMENT AND OF THE COUNCIL of 8 June 2011 on the restriction of the use of certain hazardous substances in electrical and electronic equipment**”, this product is listed in annex-I under category: “**Monitoring and control instruments including industrial monitoring and control instruments**” and exempted from ROHS directive.

However Datakom is not using any ROHS non-compliant electronic components in the production. Only the solder contains lead. The switching to unleaded soldering is in progress.

## 21. TROUBLESHOOTING GUIDE



Below is a basic list of most often encountered troubles. More detailed investigation may be required in some cases.

### **KW and $\cos\Phi$ readings are faulty although the Amp readings are correct:**

-Current transformers are not connected to the correct inputs or some of the CTs are connected with reverse polarity. Determine the correct connections of each individual CT in order to obtain correct KW and  $\cos\Phi$  for the related phase, and then connect all CTs. Please review chapter “**AC CURRENT INPUTS**”



**Short circuit outputs of unused Current Transformers.**

### **The unit is inoperative:**

Measure the supply voltage between supply terminals.

Check that the unit's supply voltage is adequate to operating conditions.

If OK, turn all fuses off, then turn all the fuses on, starting from the supply fuse. Then test the unit again.

### **Some program parameters are skipped:**

These parameters are reserved for factory setting and cannot be modified.