



DKM-411

ADVANCED NETWORK ANALYSER WITH INTERNET COMMUNICATIONS

DESCRIPTION

The DKM-411 is an advanced precision metering device offering a 3.5" size, 320x240 pixel color TFT, together with unrivalled remote monitoring capabilities over internet in a compact and low cost package.

The unit itself is a web page and can be opened through any browser for remote monitoring.

The central monitoring feature allows monitoring of thousands of meters from one central PC.

The unit complies and mostly exceeds world's tightest safety, EMC and environmental standards for the industrial category.

Software features are complete with easy firmware upgrade process through USB port.

The Windows based PC software allows monitoring and programming through USB, RS-485, Ethernet and GPRS.

The PC based Rainbow Scada software allows monitoring and control of an unlimited number of devices from a single central location.

COMMUNICATION PORTS

Ethernet 10/100Mb

RS-485 isolated (Modbus RTU)

RS-232 for external GPRS modem

USB Host for data recording on flash memory

USB Device for PC connection

FEATURES

True RMS measurements

3.5" TFT LCD, 320x240 pixels

Internal battery backed-up real time clock

Harmonic distortion display (63 harmonics)

Oscilloscope, waveform display

Phasor diagram display

Max demand display

User configurable display screens

2 configurable relay outputs

Free internet based monitoring program

2 opto-isolated, configurable digital inputs

Dual active-reactive power counters

Both mains & generator energy metering

Configurable user counters

Voltage transformer ratio for MV applications

Password protected front panel programming

Reduced panel depth

Sealed front panel (IP54)

TOPOLOGIES

3 phases 4 wires, star

3 phases 3 wires, 3 CTs

3 phases 3 wires, 2 CTs (L1-L2)

3 phases 3 wires, 2 CTs (L1-L3)

3 phases 4 wires, delta

2 phases 3 wires, L1-L2

1 phase 2 wires



COPYRIGHT NOTICE

Any unauthorized use or copying of the contents or any part of this document is prohibited. This applies in particular to trademarks, model denominations, part numbers and drawings.

ABOUT THIS DOCUMENT

This document describes minimum requirements and necessary steps for the successful installation of the DKM-411 family units.

Follow carefully advices given in the document. These are often good practices for the installation of genset control units which reduce future issues.

For all technical queries please contact Datakom at below e-mail address:

datakom@datakom.com.tr

QUERRIES

If additional information to this manual is required, please contact the manufacturer directly at below e-mail address:

datakom@datakom.com.tr

Please provide following information in order to get answers to any question:

- Device model name (see the back panel of the unit),
- Complete serial number (see the back panel of the unit),
- Firmware version (read from the display screen),
- Measuring-circuit voltage and power supply voltage,
- Precise description of the query.

REVISION HISTORY

REV.	DATE	AUTHOR	DESCRIPTION
01	04-12-2012	MH	First issue

RELATED DOCUMENTS

FILENAME	DESCRIPTION
Rainbow Installation	Rainbow Plus Installation Guide
Rainbow Usage	Rainbow Plus Usage Guide
DYNdns account setting	Dynamic DNS Account Setting
Ethernet Configuration	Ethernet Configuration Guide
GSM Configuration	GSM Configuration Guide
Firmware Update	Firmware Update Guide
411-MODBUS	Modbus Application Manual for DKM-411
411-snmp_E_34076_DKM411	MIB file for SNMP Application of DKM-411
Rainbow Scada Installation	Rainbow Scada Installation Guide
Rainbow Scada Usage	Rainbow Scada Usage Guide

TERMINOLOGY



CAUTION: Potential risk of injury or death.



WARNING: Potential risk of malfunction or material damage.



ATTENTION: Useful hints for the understanding of device operation.

ORDERING CODES

The DKM-411 family units are available in various options and peripheral features. Please use below information for ordering the correct version:

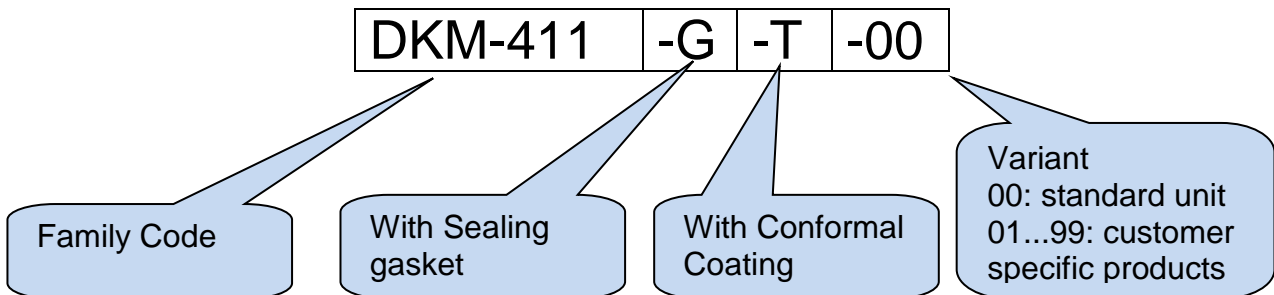

SPARE PARTS



Screw type bracket
Stock Code=J10P01 (per unit)



Self Retaining type bracket
Stock Code=K16P01 (per unit)



Sealing Gasket, Stock Code= K46P01



SAFETY NOTICE

Failure to follow below instructions will result in death or serious injury



- Electrical equipment should be installed only by qualified specialist. No responsibility is assured by the manufacturer or any of its subsidiaries for any consequences resulting from the non-compliance to these instructions.

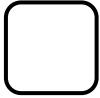

- Check the unit for cracks and damages due to transportation. Do not install damaged equipment.



- Do not open the unit. There are no serviceable parts inside.

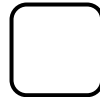

- Fuses must be connected to the power supply and phase voltage inputs, in close proximity of the unit.



- Fuses must be of fast type (FF) with a maximum rating of 6A.



- Disconnect all power before working on equipment.



- When the unit is connected to the network do not touch terminals.

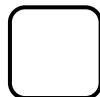

- Short circuit terminals of unused current transformers.



- Any electrical parameter applied to the device must be in the range specified in the user manual. Although the unit is designed with a wide safety margin, over-range parameters may reduce lifetime, alter operational precision or even damage the unit.



- Do not try to clean the device with solvent or the like. Only clean with a damp cloth.

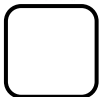

- Verify correct terminal connections before applying power.

- Only for front panel mounting.



Current Transformers must be used for current measurement.
No direct connection allowed.

TABLE OF CONTENTS

- 1. INSTALLATION INSTRUCTIONS**
- 2. MOUNTING**
 - 2.1. DIMENSIONS
 - 2.2. SEALING, GASKET
 - 2.3. ELECTRICAL INSTALLATION
- 3. TERMINAL DESCRIPTIONS**
 - 3.1. AUXILIARY SUPPLY INPUT
 - 3.2. AC VOLTAGE INPUTS
 - 3.3. AC CURRENT INPUTS
 - 3.4. DIGITAL INPUTS
 - 3.5. DIGITAL OUTPUTS
 - 3.6. RS-485 PORT
 - 3.7. ETHERNET PORT
 - 3.8. USB DEVICE PORT
 - 3.9. USB HOST PORT
 - 3.10. MODEM PORT
 - 3.11. EXTERNAL GSM MODEM (DKG-090)
- 4. TOPOLOGIES**
 - 4.1. SELECTING THE TOPOLOGY
 - 4.2. 3 PHASE, 4 WIRE, STAR
 - 4.3. 3 PHASE, 3 WIRE, DELTA
 - 4.4. 3 PHASE, 4 WIRE, DELTA
 - 4.5. 3 PHASE, 3 WIRE, DELTA, 2 CT (L1-L2)
 - 4.6. 3 PHASE, 3 WIRE, DELTA, 2 CT (L1-L3)
 - 4.7. 2 PHASE, 3 WIRE, DELTA, 2 CTs (L1-L2)
 - 4.7. 1 PHASE, 2 WIRE
- 5. CONNECTION DIAGRAM**
- 6. TERMINAL DESCRIPTION**
- 7. TECHNICAL SPECIFICATIONS**
- 8. DESCRIPTION OF CONTROLS**
 - 8.1. FRONT PANEL FUNCTIONALITY
 - 8.2. PUSHBUTTON FUNCTIONS
 - 8.3. DISPLAY SCREEN ORGANIZATION
 - 8.4. MEASURED PARAMETERS
- 9. WAVEFORM DISPLAY & HARMONIC ANALYSIS**
- 10. PHASOR DIAGRAM**
- 11. ANALOG DISPLAYS**
- 12. COMPARING MEASUREMENTS**
- 13. USER CONFIGURABLE DISPLAY SCREENS**
- 14. POWER COUNTERS & INCREMENTAL COUNTERS**
- 15. DEMAND VALUES**
- 16. MIN-MAX VALUES**
- 17. DISPLAYING EVENT LOGS**
- 18. PROTECTIONS AND ALARMS**

19. PROGRAMMING

- 19.1. ENTERING THE PROGRAMMING MODE
- 19.2. NAVIGATING BETWEEN MENUS
- 19.3. MODIFYING PARAMETER VALUE
- 19.4. PROGRAMMING MODE EXIT
- 19.5. RESETTING TO FACTORY SET PARAMETERS

20. PROGRAM PARAMETER LIST

- 20.1. CONTROLLER CONFIGURATION GROUP
- 20.2. ELECTRICAL PARAMETERS GROUP
- 20.3. COUNTERS MIN/MAX PARAMETERS GROUP
- 20.4. DIGITAL INPUT CONFIGURATION
- 20.5. OUTPUT CONFIGURATION
- 20.6. USER INPUT STRINGS
- 20.7. CONFIGURING USER DISPLAY SCREENS
- 20.8. SITE-ID STRING
- 20.9. DEVICE SERIAL NUMBER
- 20.10. SMS1-2-3-4 TELEPHONE NUMBERS
- 20.11. ADJUST DATE AND TIME
- 20.12. GSM MODEM PARAMETERS
- 20.13. ETHERNET PARAMETERS

21. ETHERNET CONFIGURATION**22. GSM CONFIGURATION****23. DYNAMIC DNS FEATURE****24. ACCESSING THE EMBEDDED WEB SERVER****25. WEB MONITORING****26. CENTRAL MONITORING****27. E-MAIL SENDING****28. ETHERNET/GPRS – MODBUS GATEWAY OPERATION****29. SMS COMMANDS****30. DATA RECORDING**

- 30.1. DATA RECORDING MEDIA
- 30.2. DIRECTORY STRUCTURE
- 30.3. UNDERSTANDING THE CSV FORMAT
- 30.4. RECORDED DATA LIST, RECORD PERIOD

31. MODBUS COMMUNICATIONS

- 31.1. PARAMETERS REQUIRED FOR RS-485 MODBUS OPERATION
- 31.2. PARAMETERS REQUIRED FOR MODBUS-TCP/IP VIA ETHERNET
- 31.3. DATA FORMATS

32. SNMP COMMUNICATIONS

- 32.1. PARAMETERS REQUIRED FOR SNMP VIA ETHERNET

33. CALIBRATION**34. DECLARATION OF CONFORMITY****35. MAINTENANCE****36. DISPOSAL OF THE UNIT****37. ROHS COMPLIANCE****38. TROUBLESHOOTING GUIDE**

1. INSTALLATION INSTRUCTIONS

Before installation:

- Read the user manual carefully, determine the correct connection diagram.
- Remove all connectors and mounting brackets from the unit, then pass the unit through the mounting opening.
- Put mounting brackets and tighten. Do not tighten too much, this can brake the enclosure.
- Make electrical connections with plugs removed from sockets, then place plugs to their sockets.
- Be sure that adequate cooling is provided.
- Be sure that the temperature of the environment will not exceed the maximum operating temperature in any case.

Below conditions may damage the device:

- Incorrect connections.
- Incorrect power supply voltage.
- Voltage at measuring terminals beyond specified range.
- Voltage applied to digital inputs over specified range.
- Current at measuring terminals beyond specified range.
- Overload or short circuit at relay outputs
- Connecting or removing data terminals when the unit is powered-up.
- High voltage applied to communication ports.
- Ground potential differences at non-isolated communication ports. (USB, RS-232)
- Excessive vibration, direct installation on vibrating parts.



Current Transformers must be used for current measurement.

No direct connection allowed.

Below conditions may cause abnormal operation:

- Power supply voltage below minimum acceptable level.
- Power supply frequency out of specified limits
- Phase order of voltage inputs not correct.
- Current transformers not matching related phases.
- Current transformer polarity incorrect.

2. MOUNTING

2.1. DIMENSIONS

Dimensions: 102x102x49mm (4.0"x4.0"x2.0")
Panel Cutout: 92x92mm minimum (3.62"x3.62")
Weight: 480g (1.1 lb)

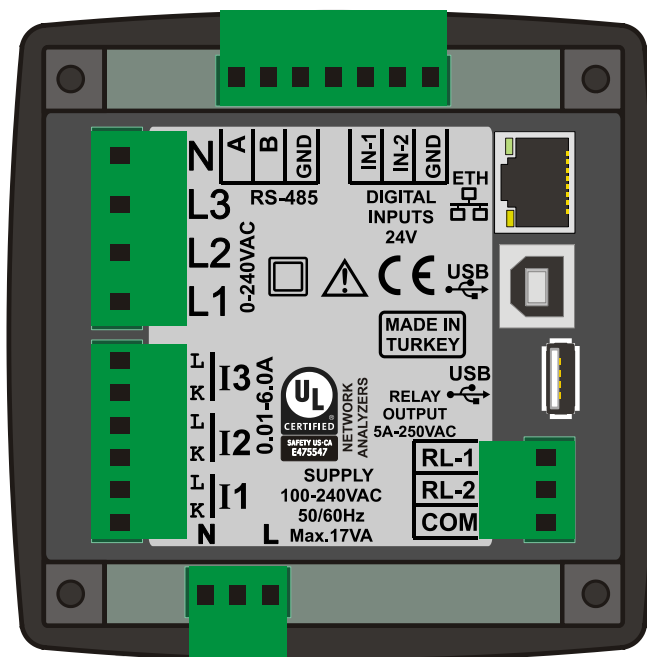
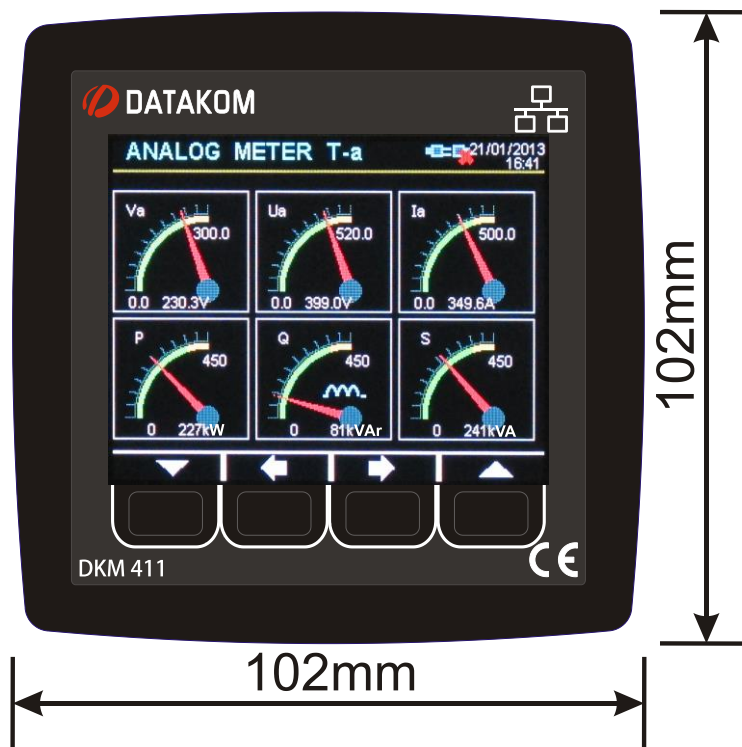



**The unit is designed for panel mounting.
The user should not be able to access parts of the
unit other than the front panel.**

Mount the unit on a flat, vertical surface. Before mounting, remove the mounting brackets and connectors from the unit, then pass the unit through the mounting opening.

Place and tighten mounting brackets.

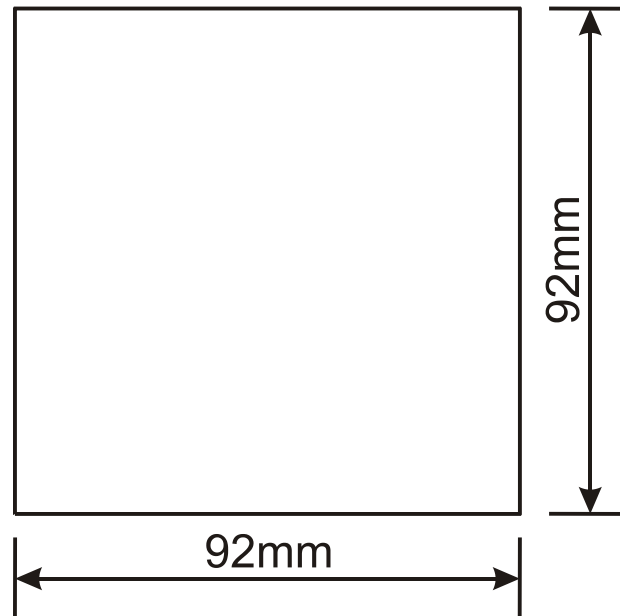

Panel Cutout

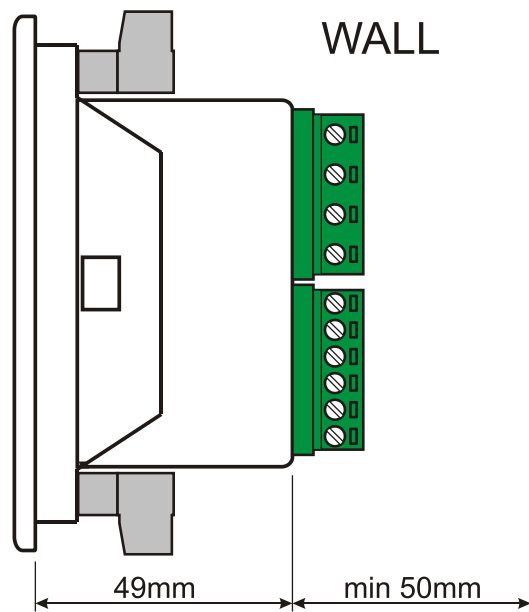

Required Panel Depth

Two different types of brackets are provided:



Screw type bracket



Self retaining type bracket



Installation of screw type bracket



Installation of self retaining type bracket

 **Do not tighten too much, this may break the unit.**

2.2. SEALING, GASKET

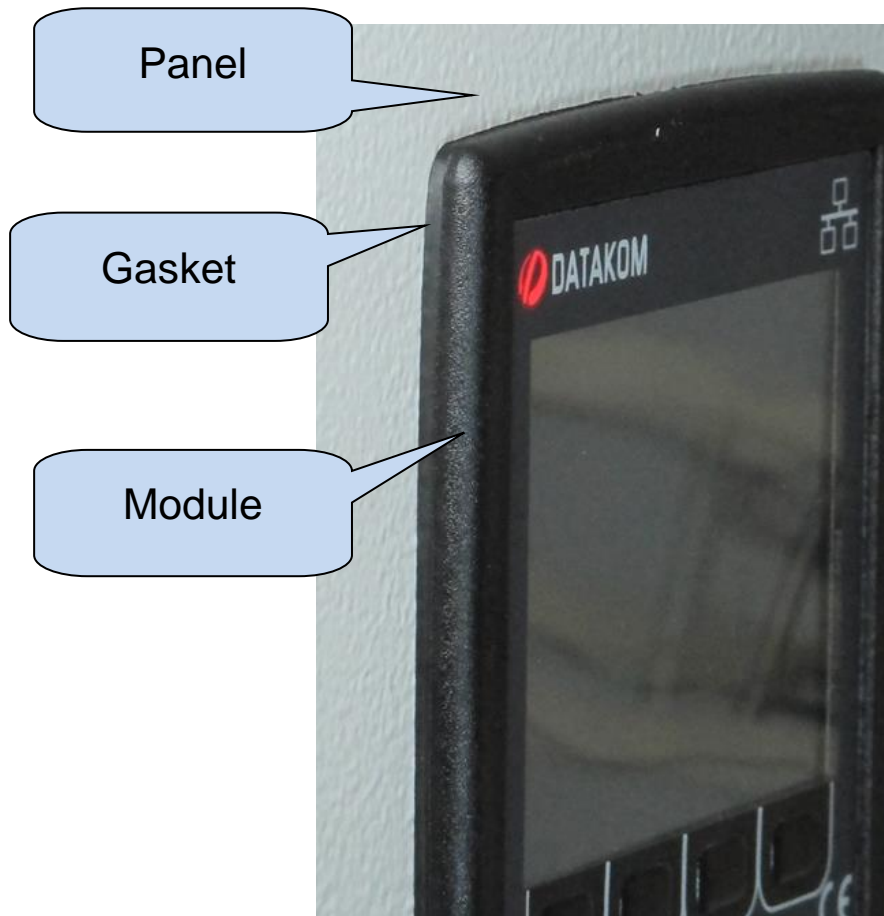

The rubber gasket provides a watertight means of mounting the module to the gasket panel. Together with the gasket, IEC 60529-IP65 protection can be reached from the front panel. A short definition of IP protection levels is given below.

1st Digit

0 Not protected

1 Protected against solid foreign objects of 50 mm diameter and greater

2 Protected against solid foreign objects of 12,5 mm diameter and greater

3 Protected against solid foreign objects of 2,5 mm diameter and greater

4 Protected against solid foreign objects of 1,0 mm diameter and greater

5 Protected from the amount of dust that would interfere with normal operation

6 Dust tight

2nd Digit

0 Not protected

1 Protected against vertically falling water drops

2 Protected against vertically falling water drops when enclosure is tilted up to 15 °

3 Protected against water sprayed at an angle up to 60 ° on either side of the vertical

4 Protected against water splashed against the component from any direction

5 Protected against water projected in jets from any direction

6 Protected against water projected in powerful jets from any direction

7 Protected against temporary immersion in water

8 Protected against continuous immersion in water, or as specified by the user

2.3. ELECTRICAL INSTALLATION



Do not install the unit close to high electromagnetic noise emitting devices like contactors, high current busbars, switchmode power supplies and the like.

Although the unit is protected against electromagnetic disturbance, excessive disturbance can affect the operation, measurement precision and data communication quality.

- **ALWAYS** remove plug connectors when inserting wires with a screwdriver.
- **Fuses must be connected to the power supply and phase voltage inputs, in close proximity of the unit.**
- **Fuses must be of fast type (FF) with a maximum rating of 6A.**
- **Use cables of appropriate temperature range.**
- **Use adequate cable section, at least 0.75mm² (AWG18).**
- **Follow national rules for electrical installation.**
- **Current transformers must have 5A output.**
- **For current transformer inputs, use at least 1.5mm² section (AWG15) cable.**
- **The current transformer cable length should not exceed 1.5 meters. If longer cable is used, increase the cable section proportionally.**



Current Transformers must be used for current measurement.

No direct connection allowed.



For the correct recording of events, adjust the real time clock of the unit through programming menu.

3. TERMINAL DESCRIPTIONS

3.1. AUXILIARY SUPPLY INPUT

Supply voltage:	90 to 300V AC DC supply version: 19-150V DC
Maximum operating current:	20mA (All options included, digital outputs open.)
Maximum operating power:	< 5VA (All options included, digital outputs open.)
Isolation	3500VAC/1minute from all other terminals.

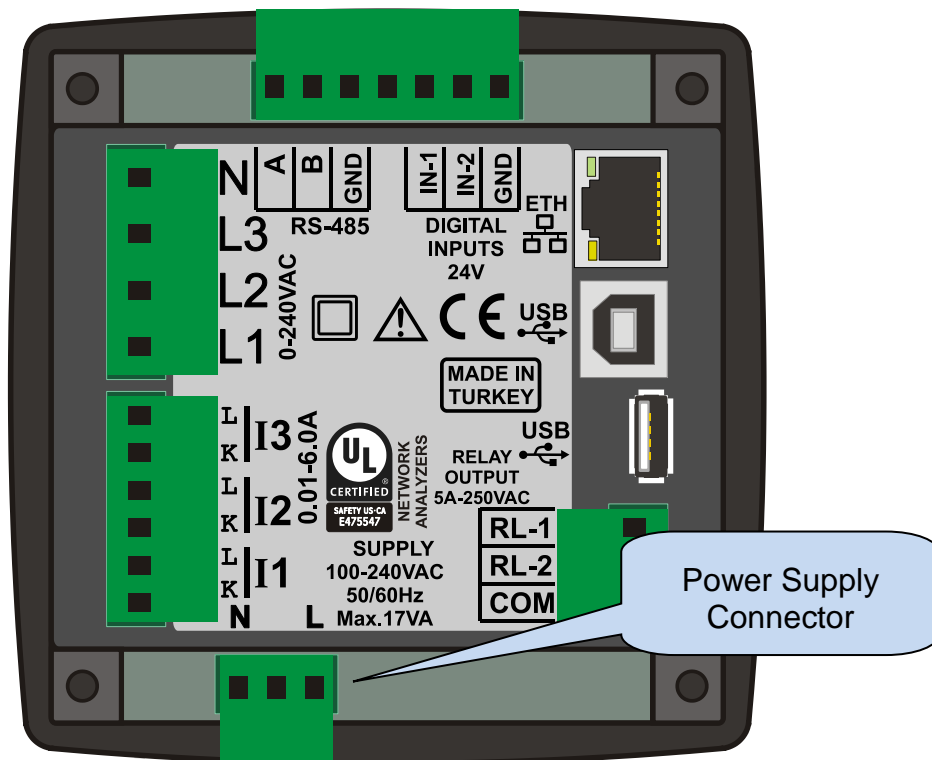

The connection cables for the power supply voltage must be fused with a UL listed fuse (6A type C).

3.2. AC VOLTAGE INPUTS

Measurement method:	True RMS
Sampling rate:	8000 Hz
Harmonic analysis:	up to 63th harmonic
Input voltage range:	0 to 300 VAC
Supported topologies:	3 ph 4 wires star 3 ph 3 wires delta 3ph 4 wires delta 2ph 3 wires L1-L2 2ph 3 wires L1-L3 1 ph 2 wires
Measurement range:	0 to 330VAC ph-N (0 to 570VAC ph-ph)
Common mode offset:	max 1000VAC between neutral and any aux. supply terminal
Input impedance:	1M-ohms
Display resolution:	0.1VDC
Accuracy:	0.2% + 1 digit @ 230VAC ph-N (± 0.6 VAC ph-N) 0.2% + 1 digit @ 400VAC ph-ph (± 0.9 VAC ph-ph)

Frequency range:	DC to 500Hz
Frequency display resolution:	0.01 Hz
Frequency accuracy:	0.1% + 1 digit (± 0.06 Hz @ 50Hz)

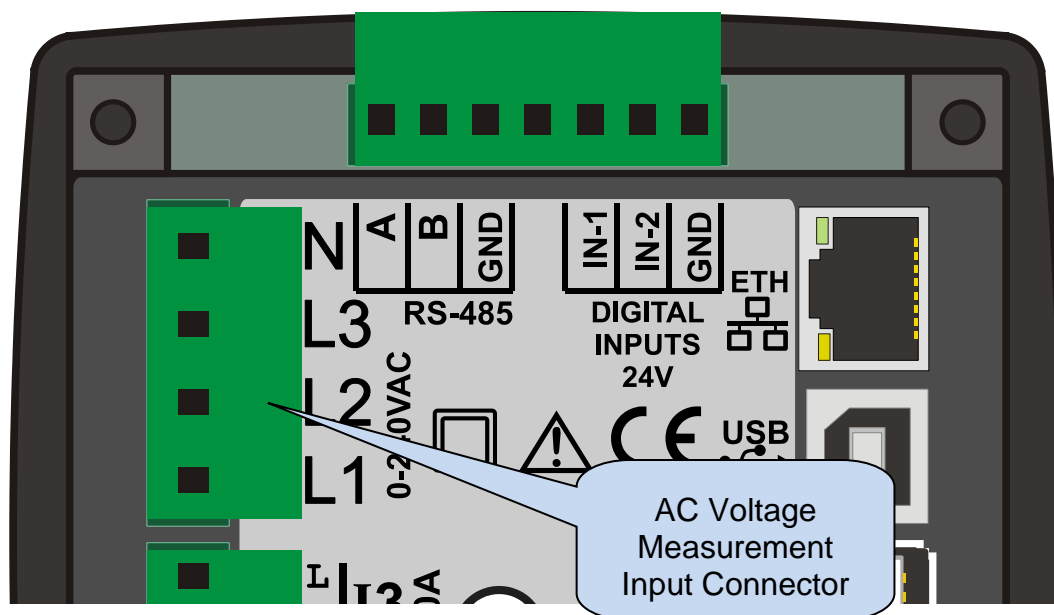

3.3. AC CURRENT INPUTS

Measurement method:	True RMS
Sampling rate:	8000 Hz
Harmonic analysis:	up to 63th harmonic
Supported topologies:	3 ph 3 CTs 3 ph 2 CTs L1-L2 3 ph 2 CTs L1-L3 2 ph 2 CTs L1-L2 2 ph 2 CTs L1-L3 1 ph 1 CT
CT secondary rating:	5A
Measurement range:	5/5 to 10000/5A minimum
Input impedance:	15 mili-ohms
Burden:	0.375W
Maximum continuous current:	6A
Measurement range:	0.1 to 7.5A
Common mode offset:	Max 50VAC between NEUTRAL and any CT terminal.
Display resolution:	0.1A
Accuracy:	0.2% + 1 digit @ 5A ($\pm 1.1A$ @ 5/500A full range)

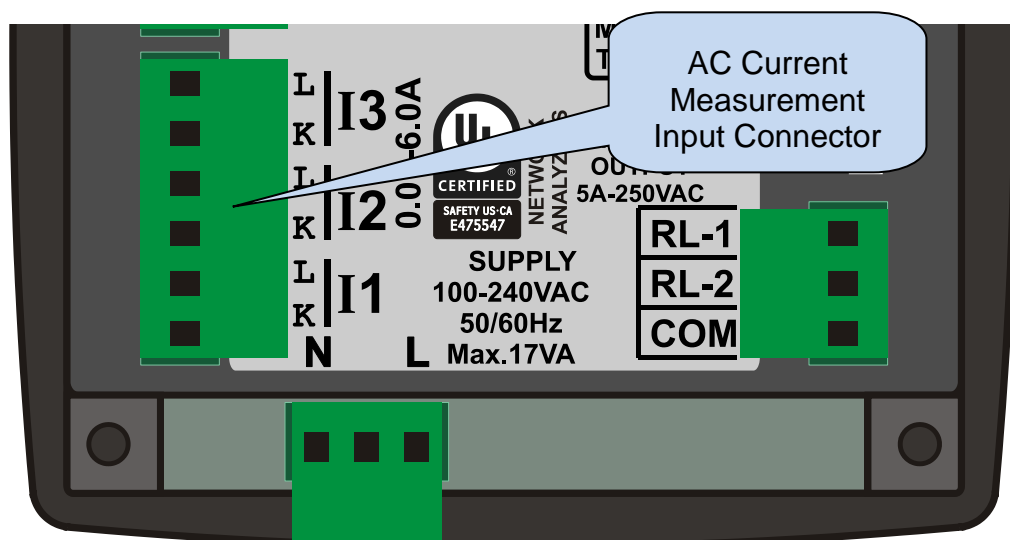

SELECTING THE CT RATING AND CABLE SECTION:

The load on a CT should be kept minimum in order to minimize phase shift effect of the current transformer. Phase shift in a CT will cause erroneous power and power factor readings, although amp readings are correct.

Datakom advises CT rating to be selected following this table for the best measurement accuracy.

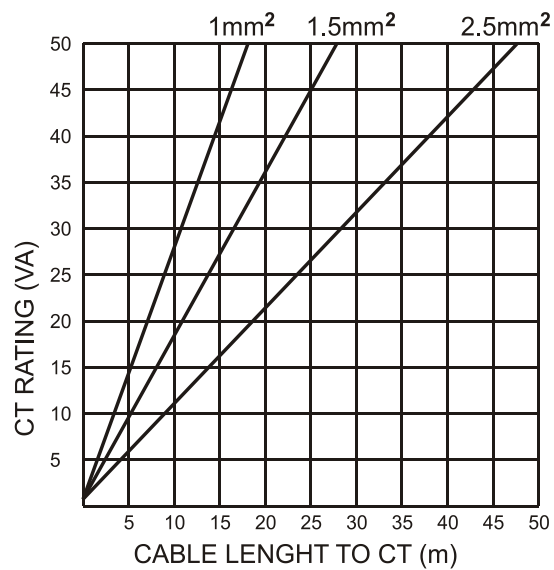
**SELECTING THE CT ACCURACY CLASS:**

The CT accuracy class should be selected in accordance with the required measurement precision. The accuracy class of the Datakom controller is 0.5%. Thus 0.5% class CTs are advised for the best result.

CONNECTING CTs:

Be sure of connecting each CT to the related phase input with the correct polarity. Mixing CTs between phases will cause faulty power and pf readings.

Many combinations of incorrect CTs connections are possible, so check both order of CTs and their polarity. Reactive power measurement is affected by incorrect CTs connection in similar way as active power measurement.

CORRECT CT CONNECTIONS

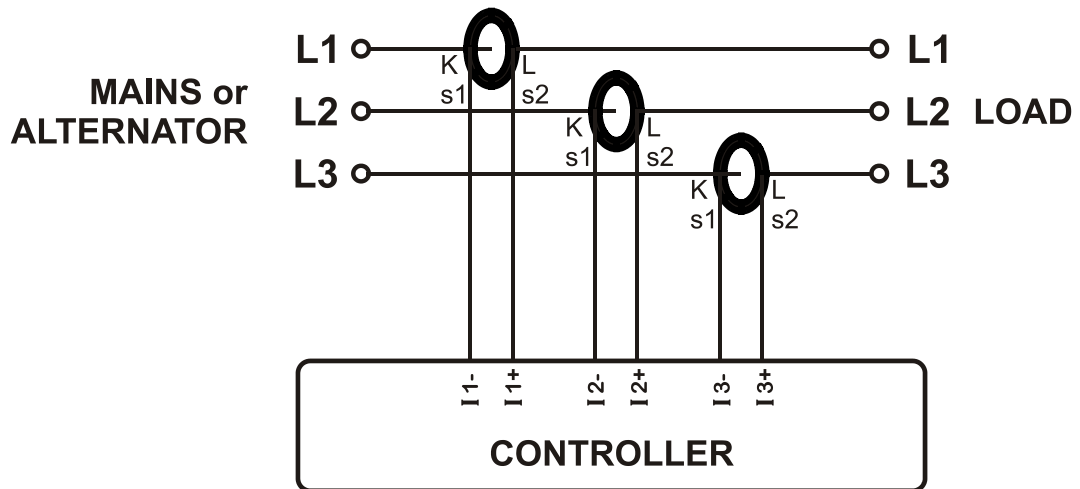

Let's suppose that the genset is loaded with 100 kW on each phase. The load Power Factor (PF) is 1. Measured values are as follows:

	kW	kVAr	kVA	pf
Phase L1	100.0	0.0	100	1.00
Phase L2	100.0	0.0	100	1.00
Phase L3	100.0	0.0	100	1.00
Total	300.0	0.0	300	1.00

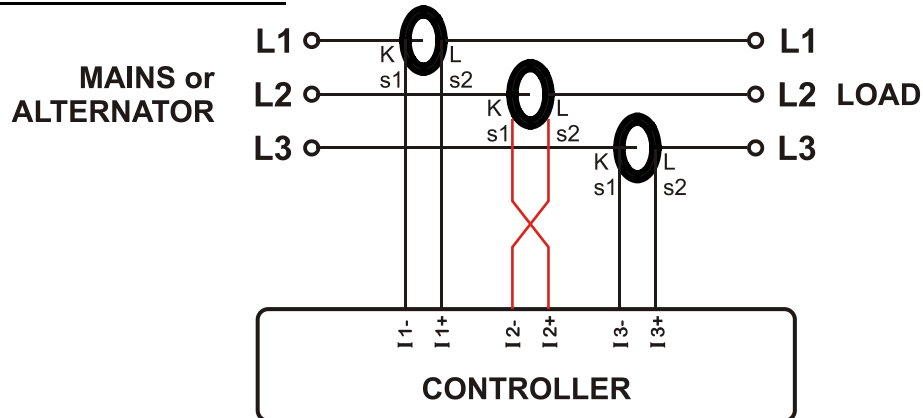
EFFECT OF POLARITY REVERSAL

The network is still loaded with 100 kW on each phase. The load Power Factor (PF) is 1. PF in phase L2 will show -1,00 due to reverse CT polarity. The result is that total measured power displayed by the analyser is 100 kW. Measured values are as follows:

	kW	kVAr	kVA	pf
Phase L1	100.0	0.0	100	1.00
Phase L2	-100.0	0.0	100	-1.00
Phase L3	100.0	0.0	100	1.00
Total	100.0	0.0	300	0.33

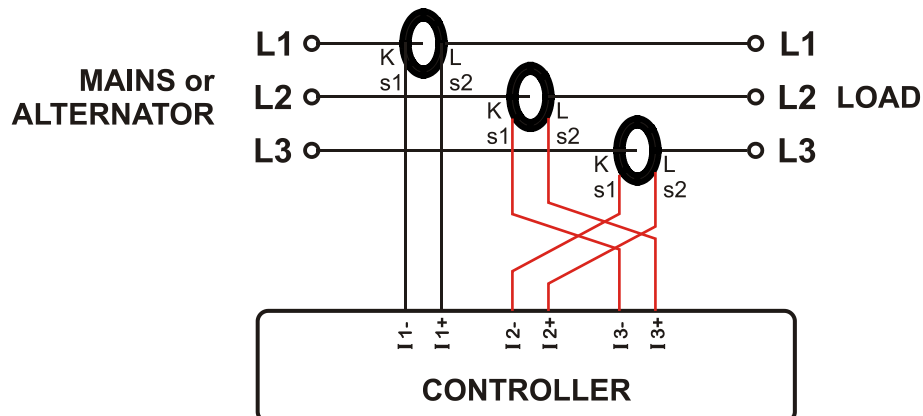
EFFECT OF PHASE SWAPPING

The network is still loaded with 100 kW on each phase. The load Power Factor (PF) is 1. PF in phases L2 and L3 will show -0,50 due to phase shift between voltages and currents which is caused by CT swapping. The result is that total measured power displayed by controller is 0 kW. Measured values are as follows:

	kW	kVAr	kVA	pf
Phase L1	100.0	0.0	100	1.00
Phase L2	-50.0	86.6	100	-0.50
Phase L3	-50.0	-86.6	100	-0.50
Total	0.0	0.0	300	0.0

3.4. DIGITAL INPUTS

Function selection:	from list
Number of inputs:	2 inputs, all configurable
Contact type:	Normally open or normally closed (programmable)
Structure:	Opto-isolated with 10 k-ohms serial resistor.
Isolation voltage:	1000VAC, 1 minute
Measurement:	Digital
Low level threshold:	1.6VDC
High level threshold:	9.0VDC
Maximum input voltage:	±30VDC with respect to input common terminal
Noise filtering:	yes

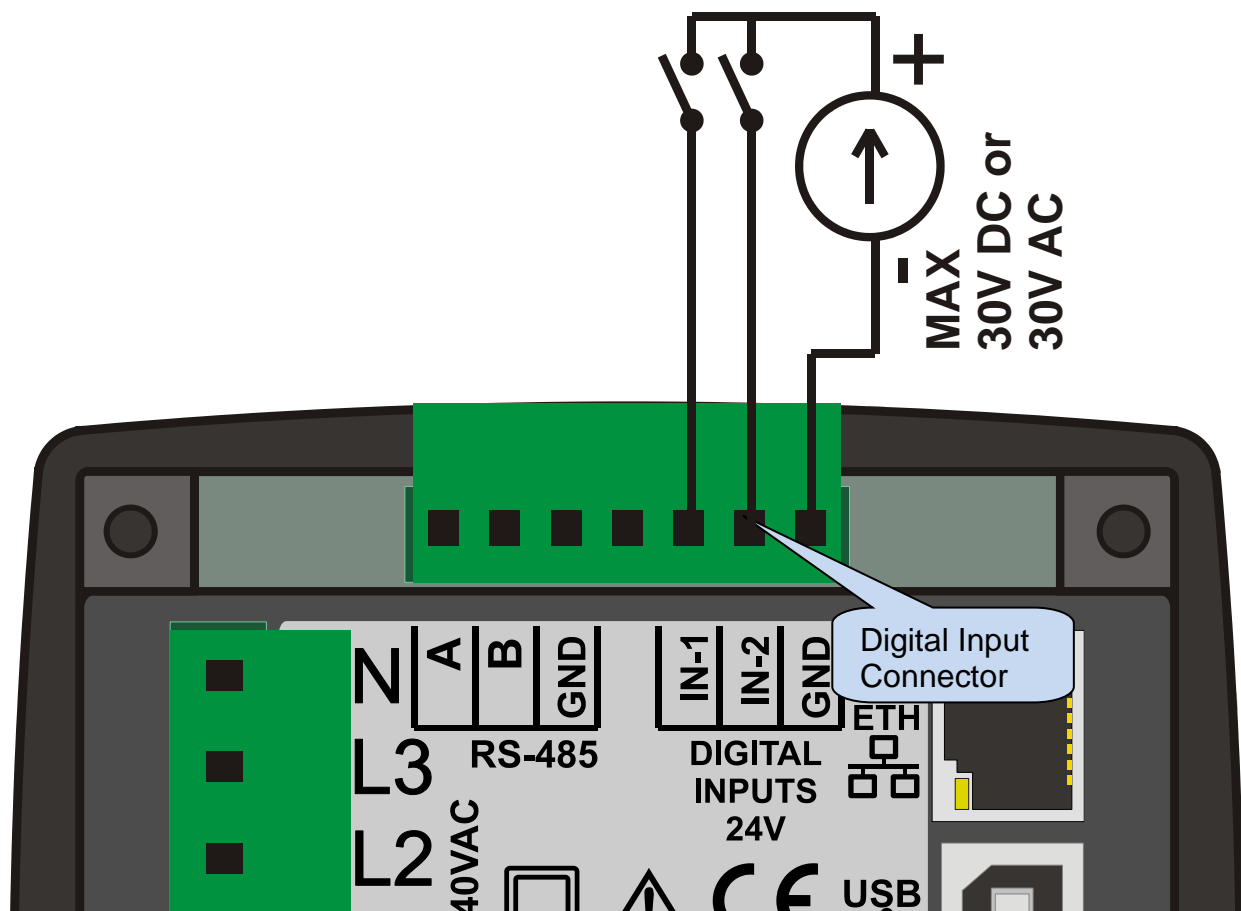

3.5. DIGITAL OUTPUTS

Structure:	Isolated relay output, normally open contact. One terminal is internally connected to relay common terminal
Number of outputs:	2 outputs, both configurable
Function selection:	from list
Max switching current:	5A @250VAC/30VDC
Max switching voltage:	250VAC
Max switching power:	1250VA
Isolation:	2000VAC from all other terminals.

INTERNAL STRUCTURE OF RELAY OUTPUTS:

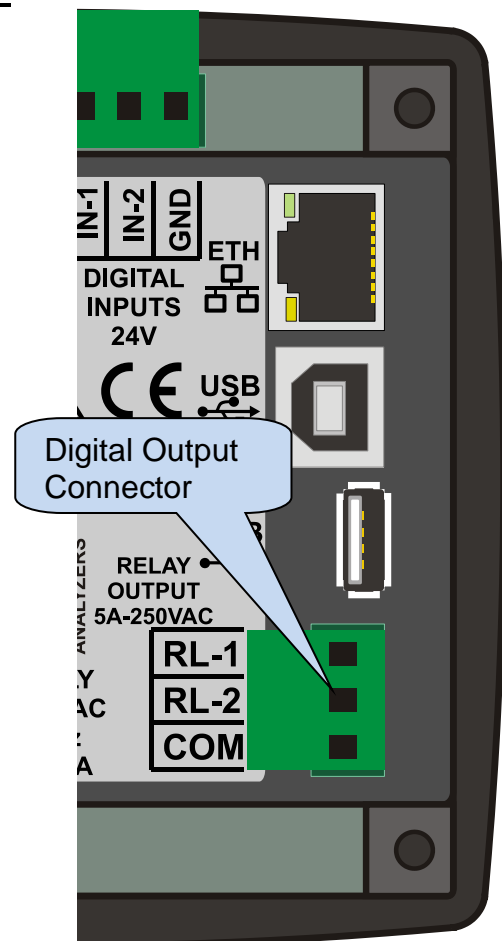
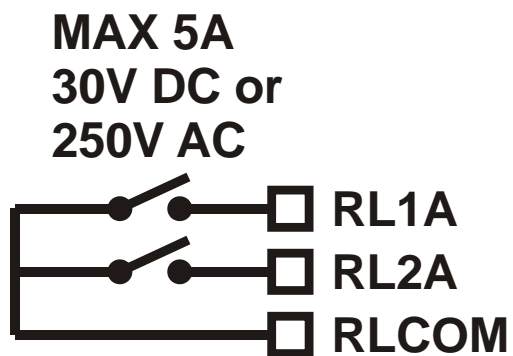

3.6. RS-485 PORT

Structure:	RS-485, isolated.
Isolation voltage:	1000VAC, 1 minute
Connection:	3 wires (A-B-GND). Half duplex.
Baud rate:	2400-115200 bauds, selectable
Data type:	8 bit data, no parity, 1 bit stop
Termination:	External 120 ohms required
Common mode voltage:	-0.5 VDC to +7VDC, internally clamped by transient suppressors.
Max distance:	1200m @ 9600 bauds (with 120 ohms balanced cable) 200m @ 115200 bauds (with 120 ohms balanced cable)

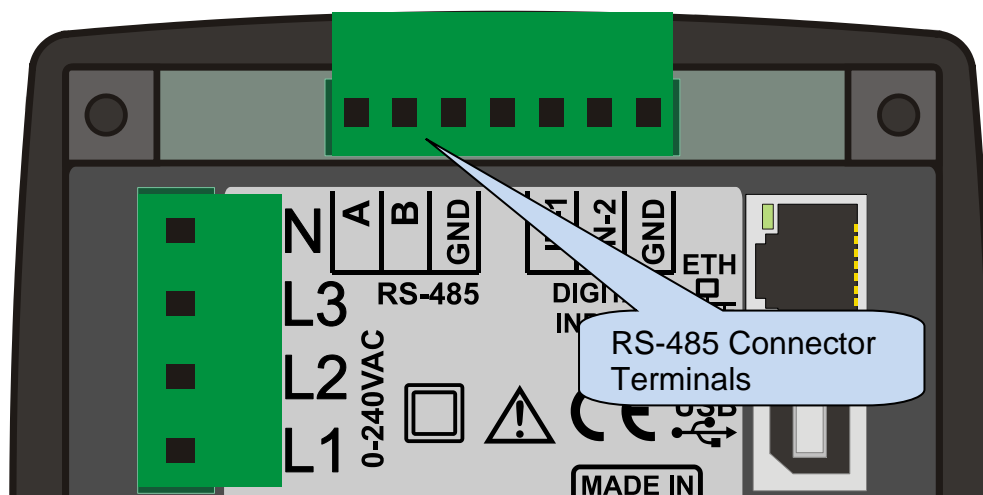

The RS-485 port features MODBUS-RTU protocol. Multiple modules (up to 128) can be paralleled on the same RS-485 bus for data transfer to automation or building management systems.



The Modbus register list is available at Datakom technical support.

The RS-485 port provides also a good solution for distant PC connection where RainbowPlus program will enable programming, control and monitoring.



For more details about programming, control and monitoring through RS-485 port please refer to RainbowPlus user manual.

RS-485 BUS STRUCTURE

A maximum of 32 devices can be paralleled on a RS-485 bus. For more devices on one bus, repeaters must be used.

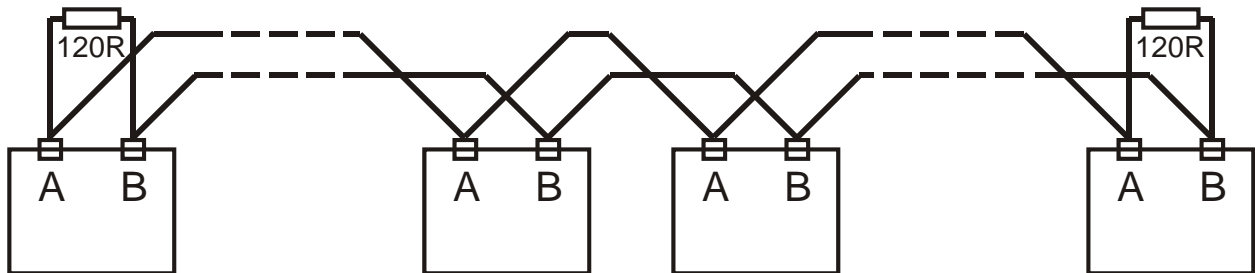

The bus must be terminated from both ends with 120 ohm resistor.

The cable shield should be grounded from one end only.



The device does not have any internal terminating resistors. External 120 ohm resistor should be added to both extremities of the bus line.

3.7. ETHERNET PORT

Description:	IEEE802.3 compliant, 10/100 Base-TX RJ45 ethernet port with indicating leds
Data rate:	10/100 Mbits/s, auto detecting
Connector:	RJ45
Cable type:	CAT5 or CAT6
Isolation:	1500 VAC, 1 minute
Max distance:	30m.
Functionality:	Embedded TCP/IP, Web Server, Web Client, SMTP, e-mail, SNMP, Modbus TCP_IP

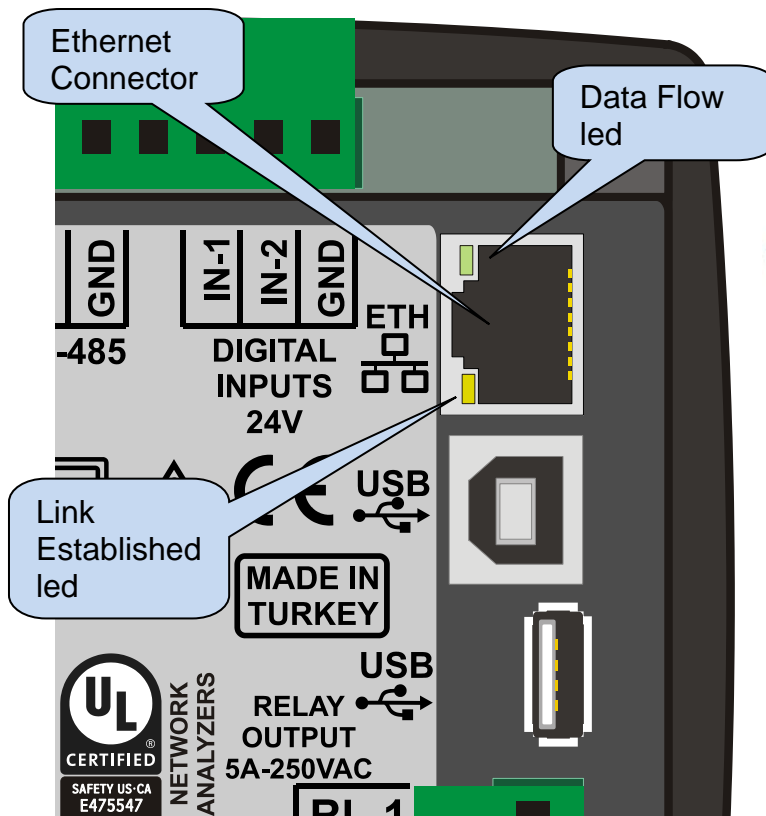

STANDARD ETHERNET CABLE

LED FUNCTIONS:

GREEN: This led turns on when the ethernet link is established (connector inserted)

YELLOW: This led blinks when data transfer occurs inwards or outwards. Periodic blinking will witness data flow.

3.8. USB DEVICE PORT

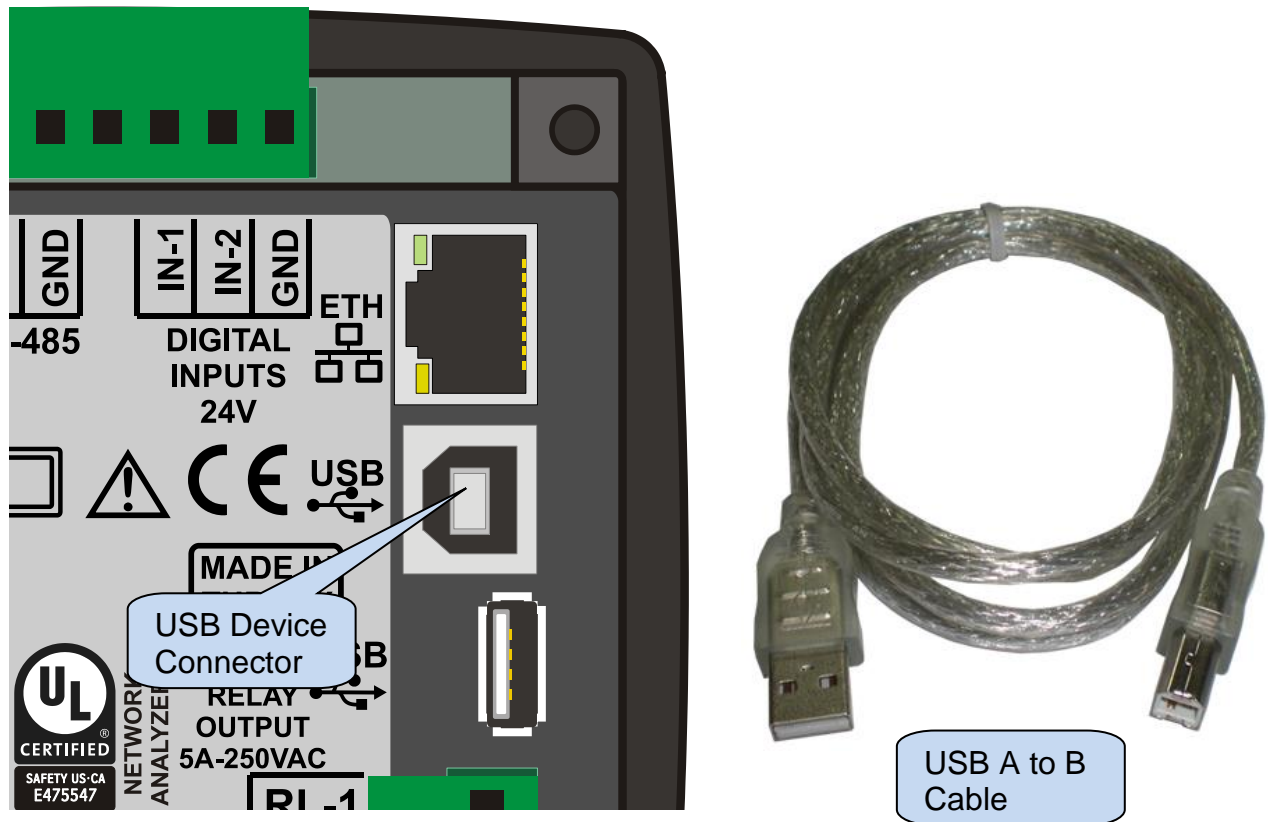

Description:	USB 2.0, not isolated, HID mode
Data rate:	Full Speed 1.5/12 Mbits/s, auto detecting
Connector:	USB-B (printer connector)
Cable length:	Max 6m
Functionality:	Modbus, FAT32 for firmware upgrade (boot loader mode only)

The USB-Device port is designed to connect the module to a PC. Using the RainbowPlus software, programming, control of the genset and monitoring of measured parameters are achieved.

The RainbowPlus software can be downloaded from www.datakom.com.tr website.

The connector on the module is of USB-B type. Thus A to B type USB cable should be used. This is the same cable used for USB printers.

For more details about programming, control and monitoring please refer to RainbowPlus user manual.



If USB-Device is plugged then USB-Host port will not function.

3.9. USB HOST PORT

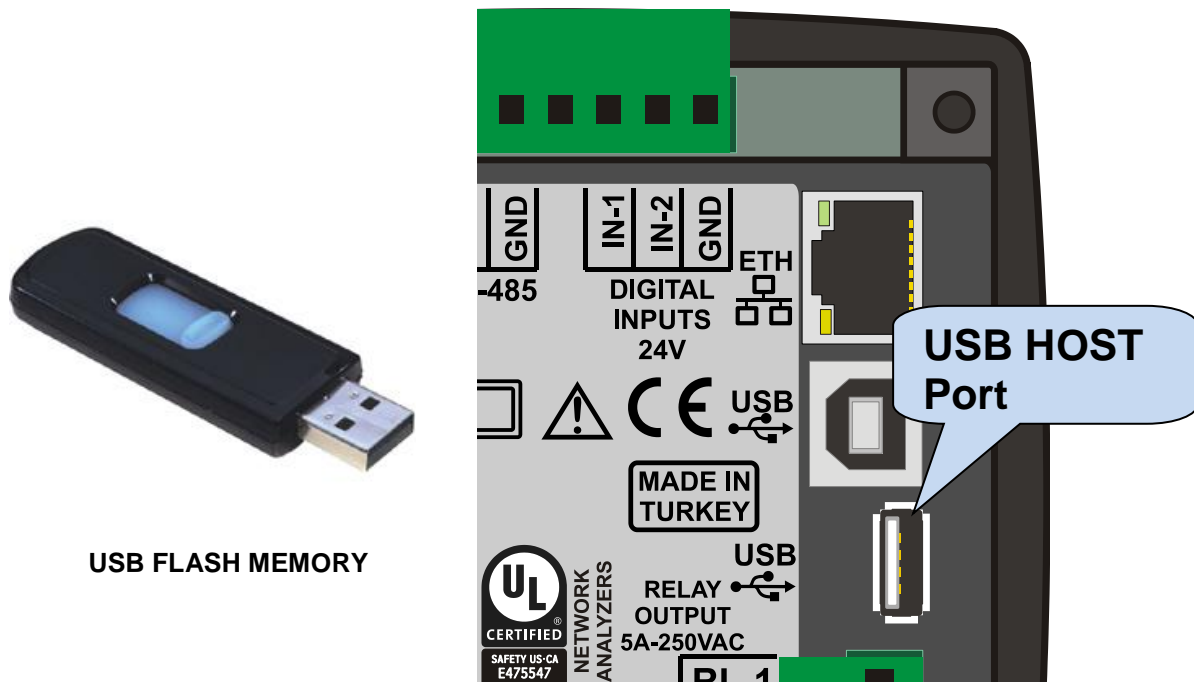

Description:	USB 2.0, not isolated
Power Supply Output:	5V, 300mA max
Data rate:	Full Speed 1.5/12 Mbits/s, auto detecting
Connector:	USB-A (PC type connector)
Cable length:	Max 1.5m
Functionality:	USB memory, FAT32, data recording
Memory capacity:	all USB flash memories.

The USB-Host port is designed for detailed data recording. The period of recording is adjustable through program parameter.

As soon as a USB flash memory is inserted, the unit will start data recording and continue until the memory is removed.

For more details about data recording please review chapter “Data Recording”.



If USB-Device is plugged then USB-Host port will not function.



The USB Flash memory must be formatted for FAT32 file system.

3.10. MODEM PORT

The modem port is a logic level serial data port, used only for the external GPRS modem connection.

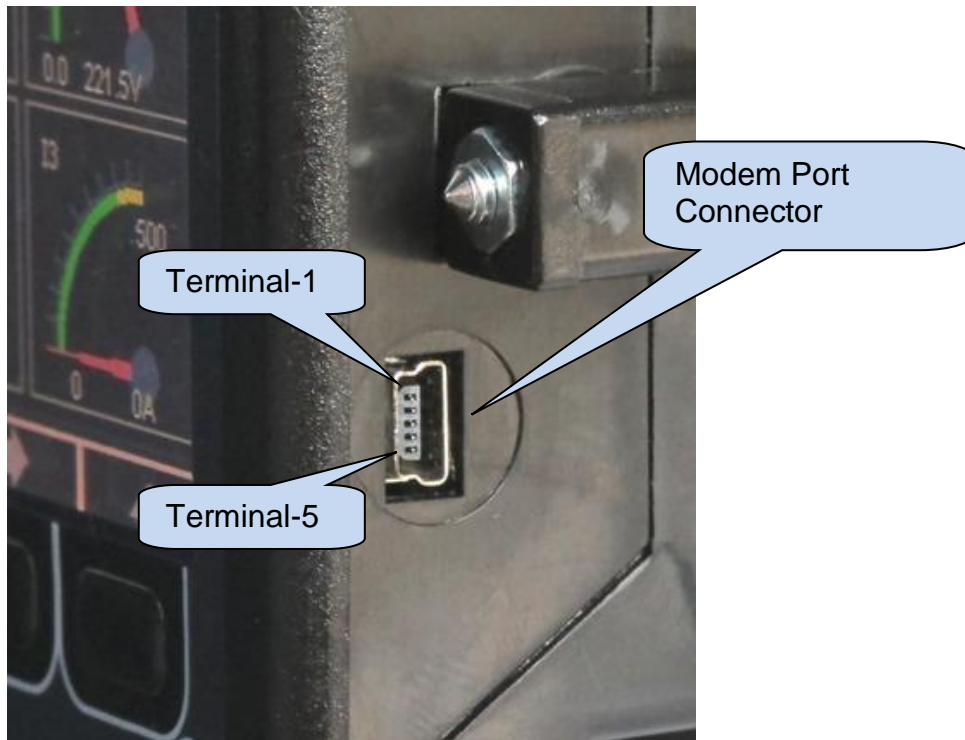

Description:	Serial data port, logic levels, non isolated.
Functionality:	External GSM modem
Connector:	Mini USB-B type
Connection:	5 wires (Rx-Tx-DTR-DTR-GND). Full duplex.
Baud rate:	2400-115200 bauds, selectable
Data type:	8 bit data, no parity, 1 bit stop
Max distance:	3m
Cable type:	Special cable, provided by manufacturer
Terminal description:	1: +5V supply (50mA max) 2: Rx input 3: Tx output 4: DTR output 5: GND



The modem connection cable is available at Datakom.

3.11. EXTERNAL GSM MODEM (DKG-090)

The optional external GSM modem is fully compatible with the unit. It does not require any special setup. The 1800/1900 MHz magnetic antenna together with its 2 meter cable is supplied with the modem. The antenna is intended to be placed outside of the control panel for the best signal reception.

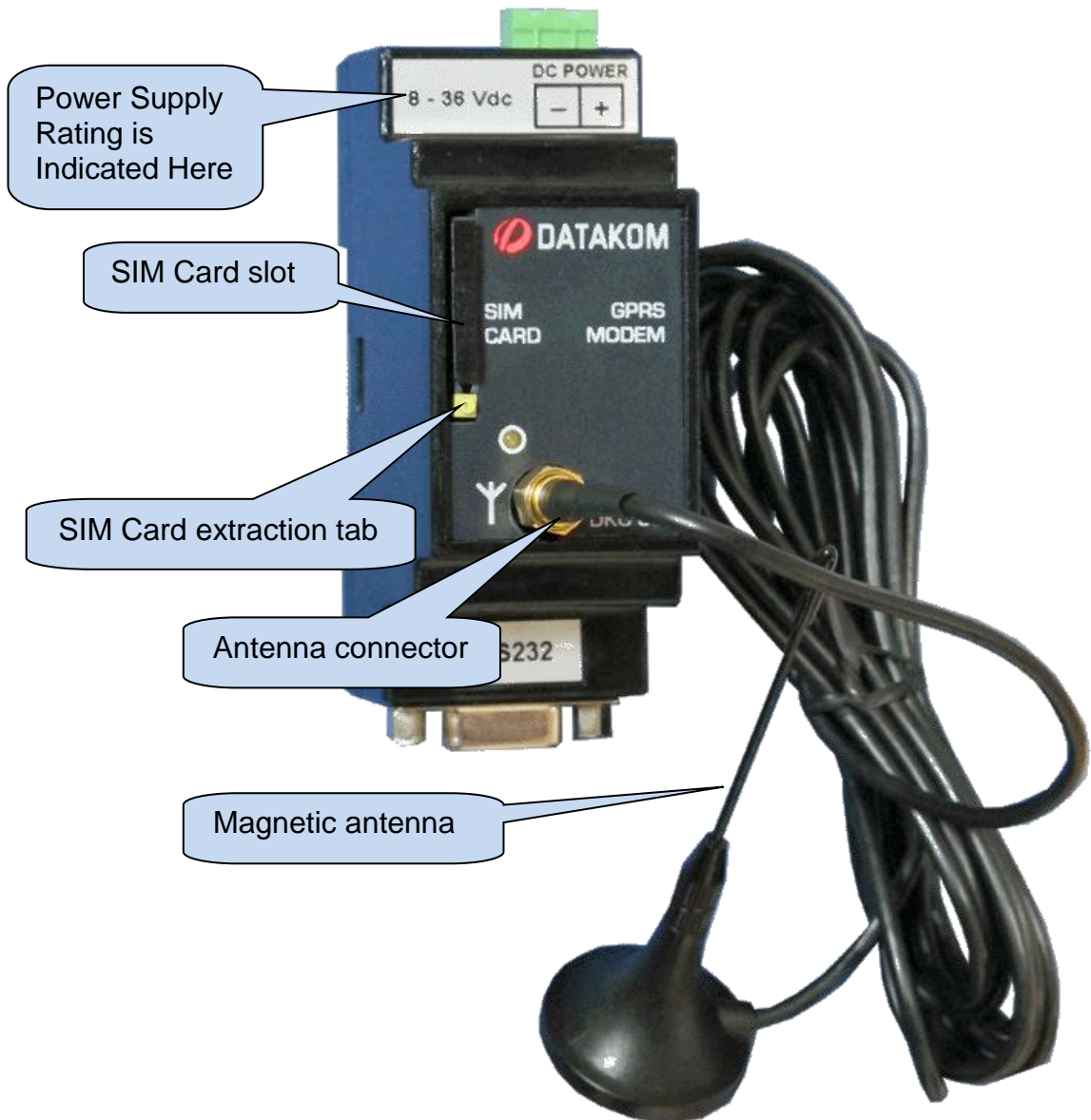

The modem is supplied in 2 versions:

DC power supply: 8-36 V-DC

AC power supply: 85-270 V-AC

MODEM CABLE DIAGRAM

DKM-411 USB PLUG

DKG-090 MODEM (D-SUB 9 PIN FEMALE)

1: +5V supply (50mA max)	6
2: Rx input	2 (Tx output)
3: Tx output	3 (Rx input)
4: DTR output	1
5: GND	5 (GND)

The module requires a GPRS enabled SIM card for full functionality. Voice-only type SIM cards will usually not function properly.

Please refer to **GSM Modem Configuration Guide** for more details.



SIM CARD EXTRACTION



**SIM CARD EXTRACTION
/ INSERTION**

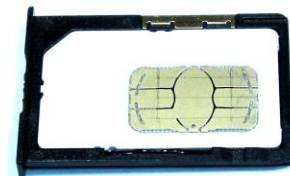

**SIM CARD
PLACEMENT**

Description:	Quad-band GSM/GPRS 850/900/1800/1900MHz module. GPRS multi-slot class 10/8 GPRS mobile station class B Compliant to GSM phase 2/2+. – Class 4 (2 W @ 850/ 900 MHz) – Class 1 (1 W @ 1800/1900MHz)
Functionality:	Web Client, SMTP, Modbus TCP/IP (client), SMS, e-mail
Power Supply Range:	DC model: 8-36VDC 1A max. AC model: 85-270 VAC, 5W max.
Operating temp range:	-40°C to +85 °C
Data speed:	max. 85.6 kbps (download), 42.8 kbps (upload)
SIM card type:	external SIM 3V/1.8V, GPRS enabled
Antenna:	Quad band, magnetic, with 2m cable
Module certificates:	CE, FCC, ROHS, PTCRB, GCF, IC, ICASA, REACH

4. TOPOLOGIES

Various topologies are selectable through program parameter.

In following drawings the connections are shown for the alternator. Current transformers are supposed connected to the alternator side.

Similar topologies re available for the mains side as well.

4.1. SELECTING THE TOPOLOGY

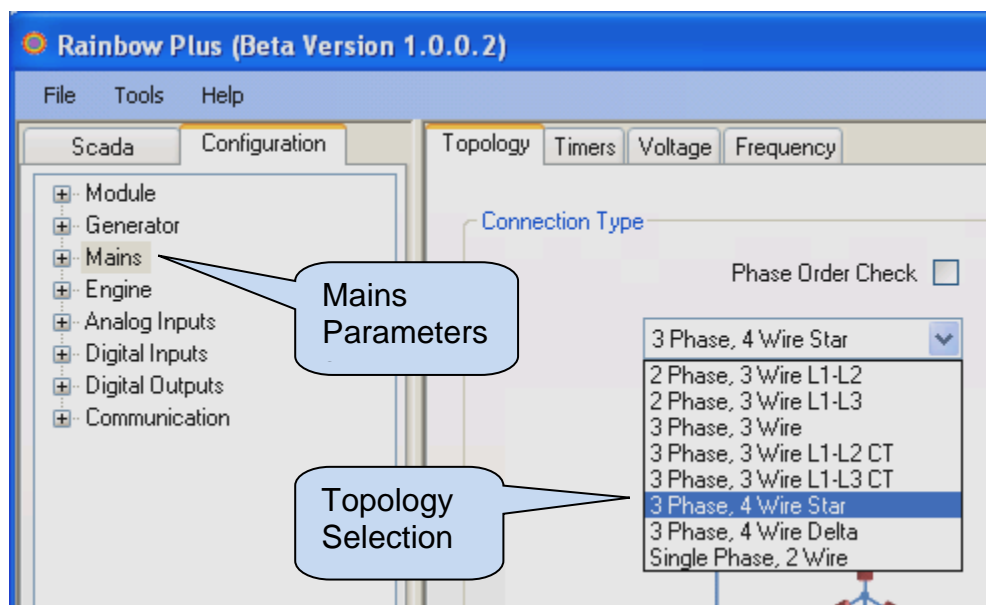
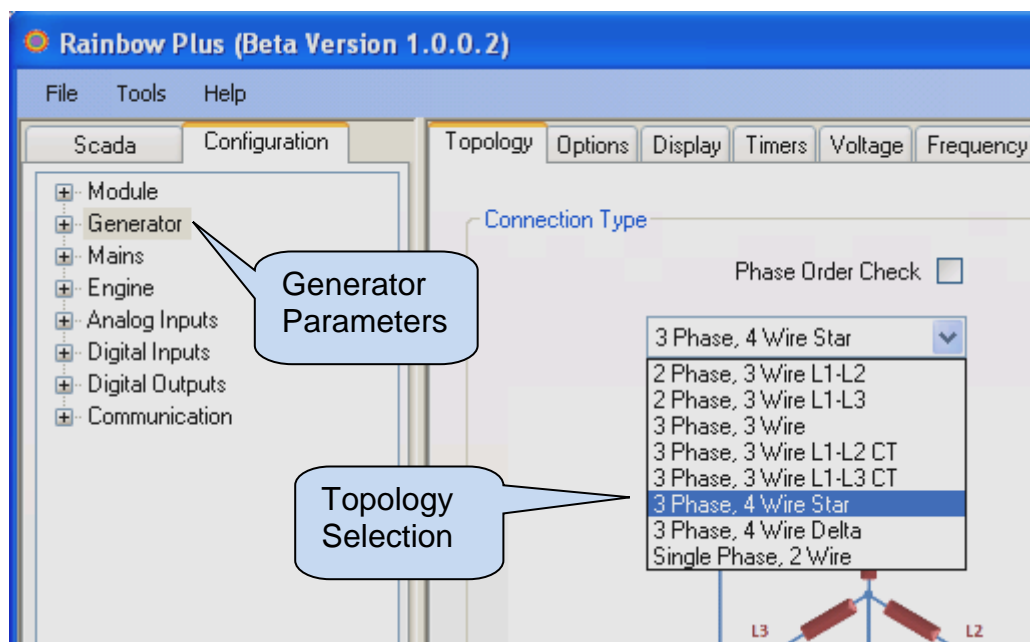

4.2. 3 PHASE, 4 WIRE, STAR

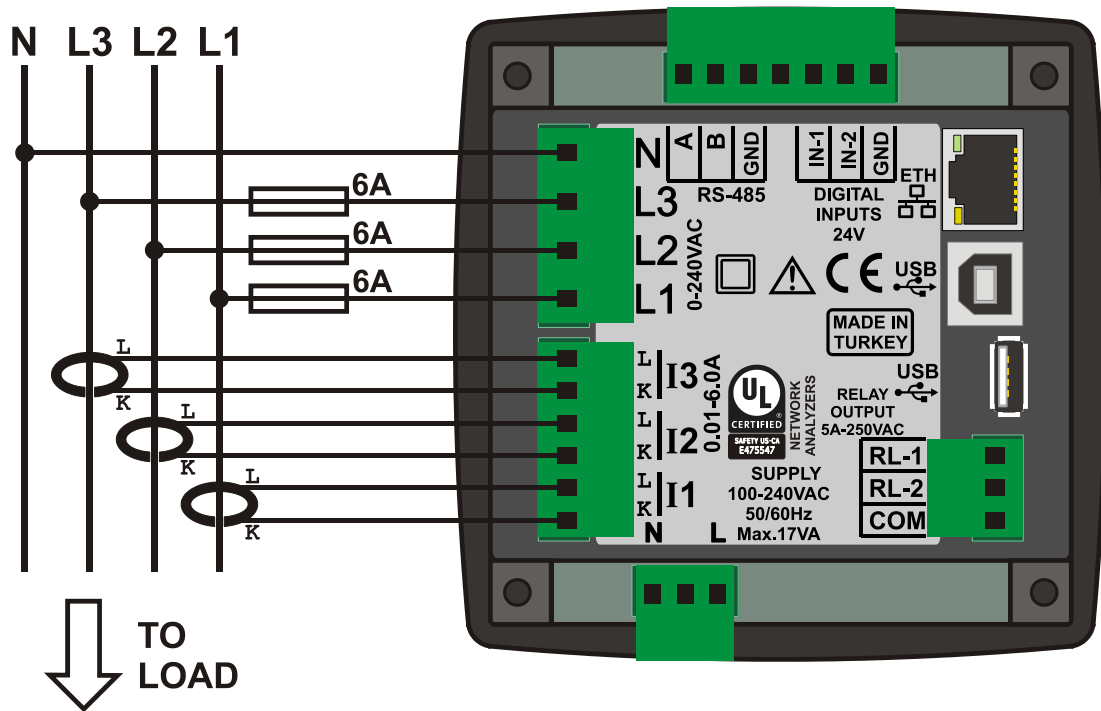

4.3. 3 PHASE, 3 WIRE, DELTA

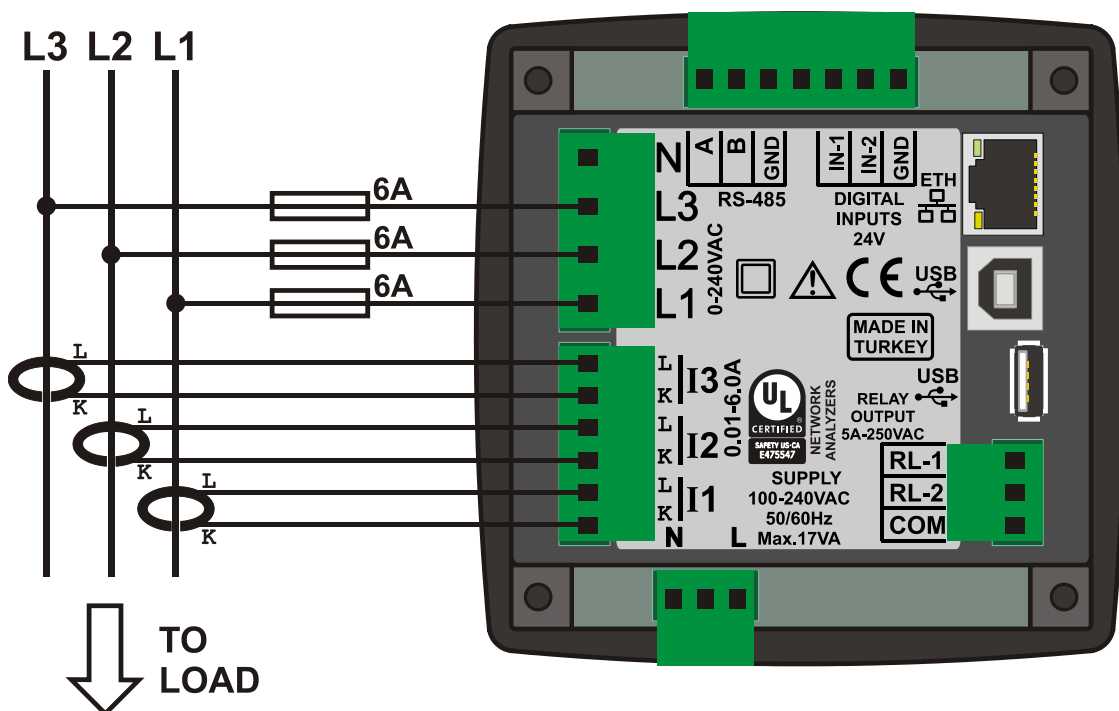

4.4. 3 PHASE, 4 WIRE, DELTA

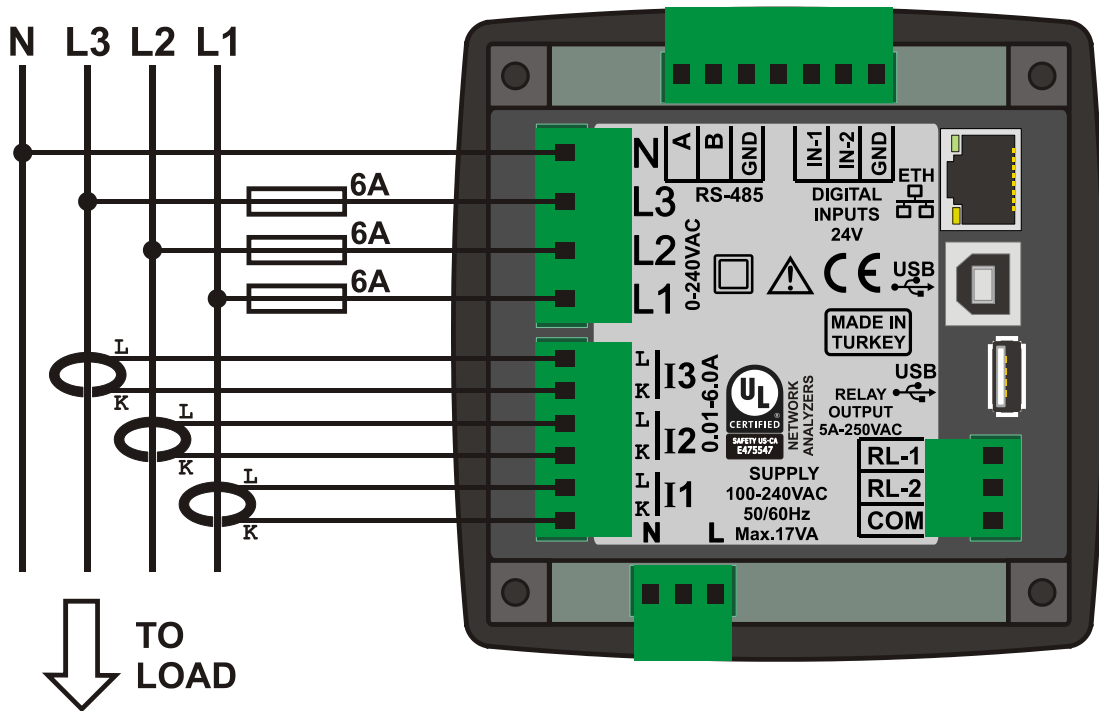

4.5. 3 PHASE, 3 WIRE, DELTA, 2 CT (L1-L2)

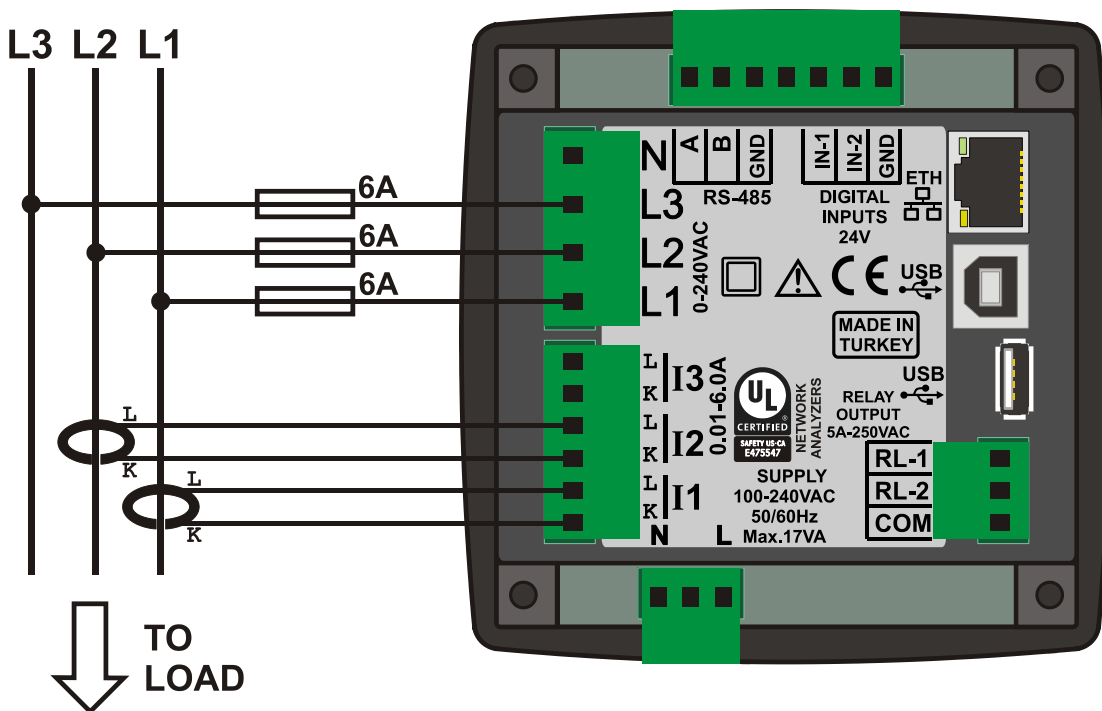

4.6. 3 PHASE, 3 WIRE, DELTA, 2 CT (L1-L3)

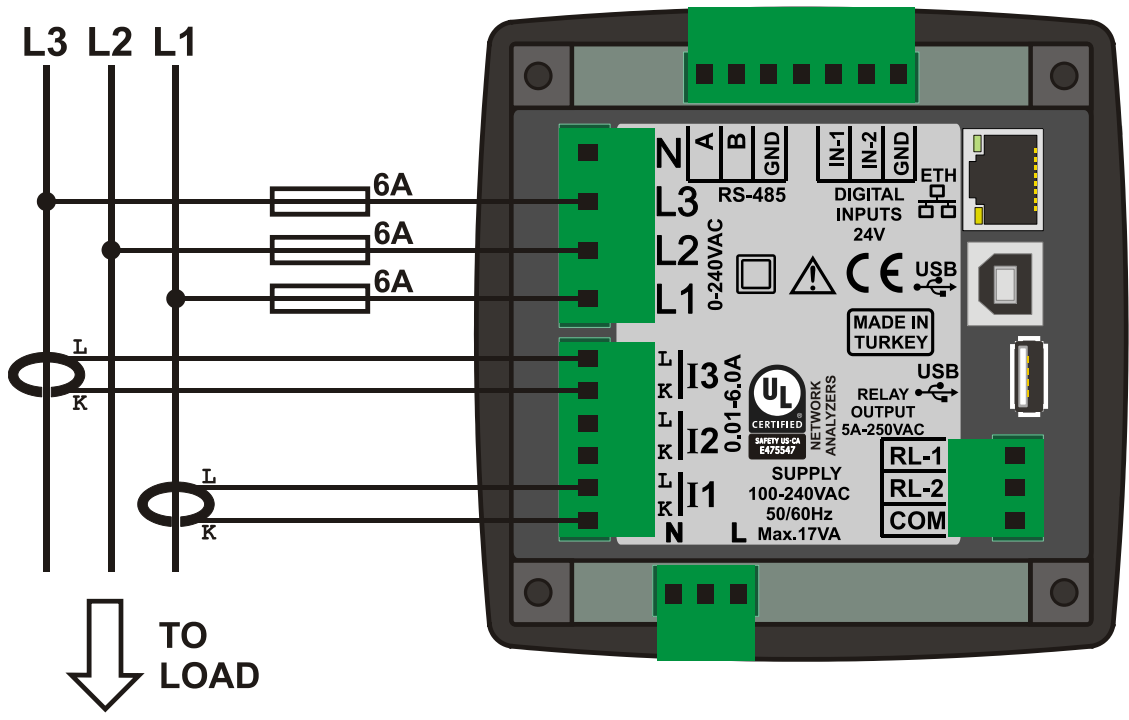

4.7. 2 PHASE, 3 WIRE, DELTA, 2 CTs (L1-L2)

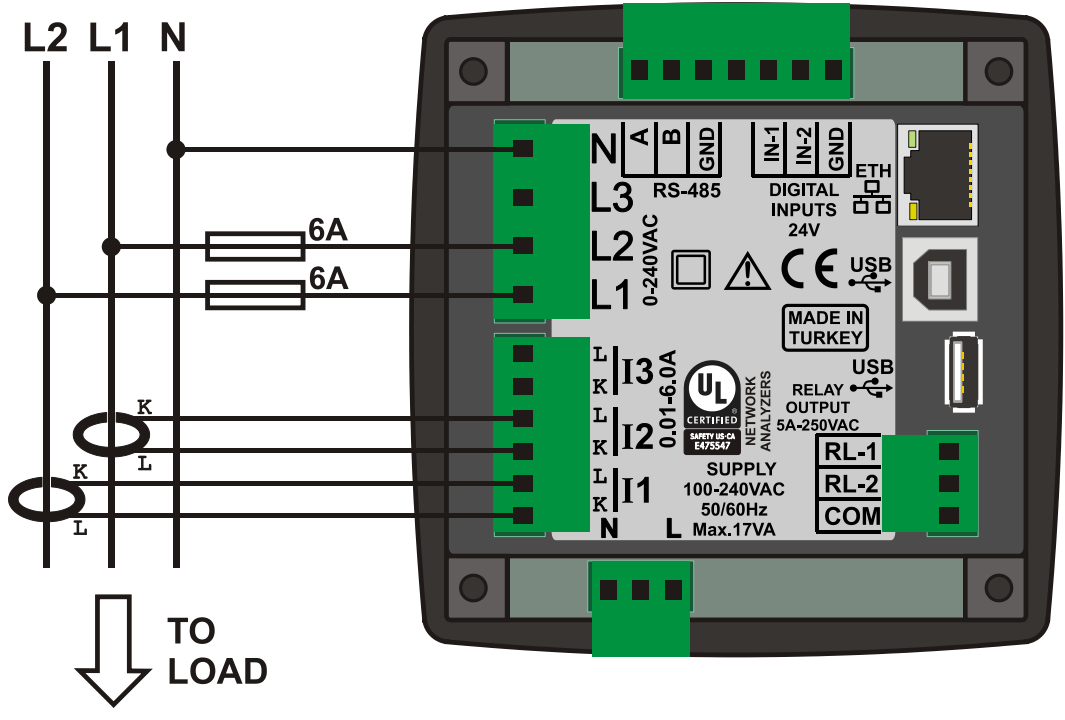

4.8. 1 PHASE, 2 WIRE

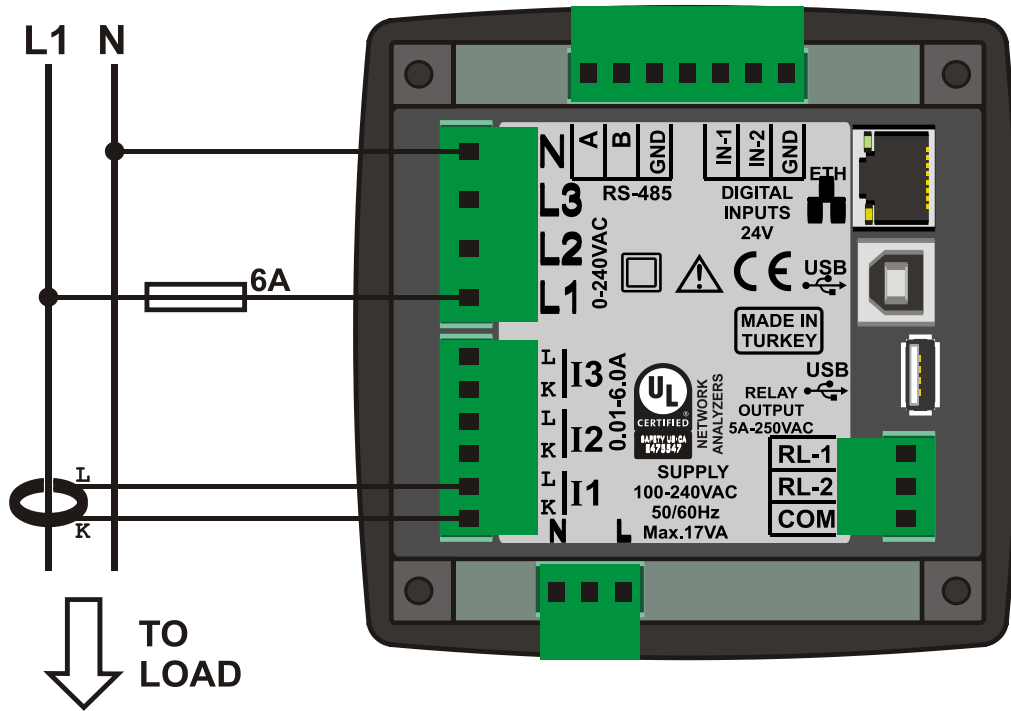

5. CONNECTION DIAGRAM

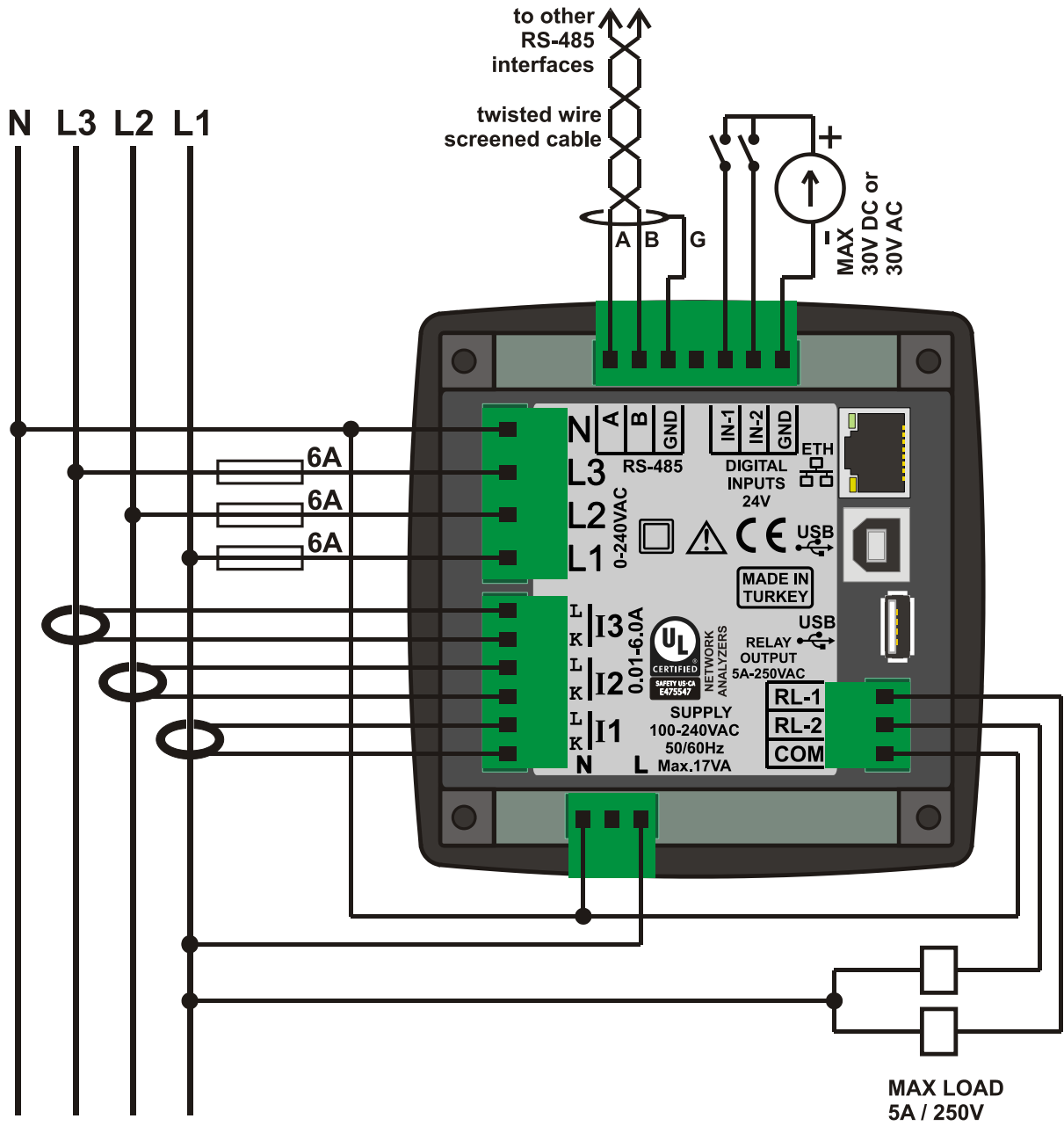

6. TERMINAL DESCRIPTION

Term	Function	Technical data	Description
	AUXILIARY SUPPLY	85 to 300VAC	Aux supply terminal
	-	-	Do not connect this terminal.
	AUXILIARY SUPPLY	85 to 300VAC	Aux supply terminal

Term	Function	Technical data	Description
	MAINS-L1	Mains phase inputs, 0-300V-AC	Connect the mains phases to these inputs.
	MAINS-L2		
	MAINS-L3		
	MAINS NEUTRAL	Input, 0-300V-AC	Neutral terminal for the mains phases.

Term	Function	Technical data	Description
	CURR_1_L	Current transformer inputs, 5A-AC	Connect the generator current transformer terminals to these inputs. Do not connect the same current transformer to other instruments otherwise a unit fault will occur. Connect each terminal of the transformer to the unit's related terminal. Do not use common terminals. Do not use grounding. Correct polarity of connection is vital. The rating of the transformers should be identical for each of the 3 phases. The secondary winding rating shall be 5 Amperes. (ex: 200/5 Amps).
	CURR_1_K		
	CURR_2_L		
	CURR_2_K		
	CURR_3_L		
	CURR_3_K		

Term	Function	Technical data	Description
	RS-485 A	Digital communication port	Connect the A-B data lines of the RS-485 link to these terminals.
	RS-485 B		
	PROTECTION GROUND	Grounding terminal	Connect the protective shield of the RS-485 cable to this terminal.

Term	Function	Technical data	Description
	DIGITAL INPUT 1	Digital Inputs, 0-30Vdc	Inputs have programmable function.
	DIGITAL INPUT 2		
	DIGITAL INPUT COMMON	Common terminal	Negative common terminal for both digital inputs.

Term	Function	Technical data	Description
	DIGITAL OUTPUT 1	Relay output, 5A/250VAC/30VDC	Relay output, normally open contact. Relay functions are programmable.
	DIGITAL OUTPUT 2	Relay output, 5A/250VAC/30VDC	Relay output, normally open contact. Relay functions are programmable.
	DIGITAL OUTPUT COMMON	Common terminal	Common input voltage for both relay outputs.

7. TECHNICAL SPECIFICATIONS

Power Supply Input:

100-240V AC nominal($\pm 20\%$)
 50 - 60Hz nominal ($\pm 10\%$)
 DC input types available.

Power Consumption: < 5 VA

Measurement Input Range:

Voltage: 5 - 300 V AC (L-N)
 10 - 520 V AC (L-L)
Current: 0.1 - 5.5 A AC
Frequency: 30 - 500 Hz

Accuracy:

Voltage: 0.2%+1 digit
Current: 0.2%+1 digit
Frequency: 0.1%+1 digit
Power (kW,kVAr): 0.4%+2digit
Power factor: 0.2%+1 digit

Measurement Range:

CT range: 5/5A to 10'000/5A
VT range: 0.1/1 to 200.0/1
kW range: 0.1 kW to 6.5MW

Voltage burden: < 0.1VA per phase

Current burden: < 0.5 VA per phase

Ethernet Port: 10/100 Mbits

USB Device: USB 2.0 Full speed

USB Host: USB 2.0 Full speed

RS-485 Port: selectable baud rate

Modem Port: logic level serial data, selectable baud rate

Relay Outputs: 5A @ 250VAC/30VDC

Digital Inputs:

Active level: 5 to 30V-DC or AC
Min pulse: 250ms.
Isolation: 1000V AC, 1 minute

Operating Temperature:

-20°C to +50°C (-4 to +122 °F).

Storage Temperature:

-30°C to +70°C (-22 to +158 °F).

Maximum humidity: 95% non-condensing.

Degree of Protection: IP 65 (Front Panel) with optional gasket
 IP 30 (Back panel)

Enclosure: Non-flammable, ROHS compliant

Installation: Flush mounting with rear brackets

Dimensions: 102x102x53mm (WxHxD)

Panel Cutout: 92x92mm

Weight: 350 gr

UL-CSA Certification:

UL 61010-1, 3rd Edition, 2012-05, CAN/CSA-C22.2

File: E475547, Vol. D1

EU Directives:

2006/95/EC (LVD)
 2004/108/EC (EMC)

Norms of reference:

EN 61010 (safety)
 EN 61326 (EMC)

8. DESCRIPTION OF CONTROLS

8.1. FRONT PANEL FUNCTIONALITY



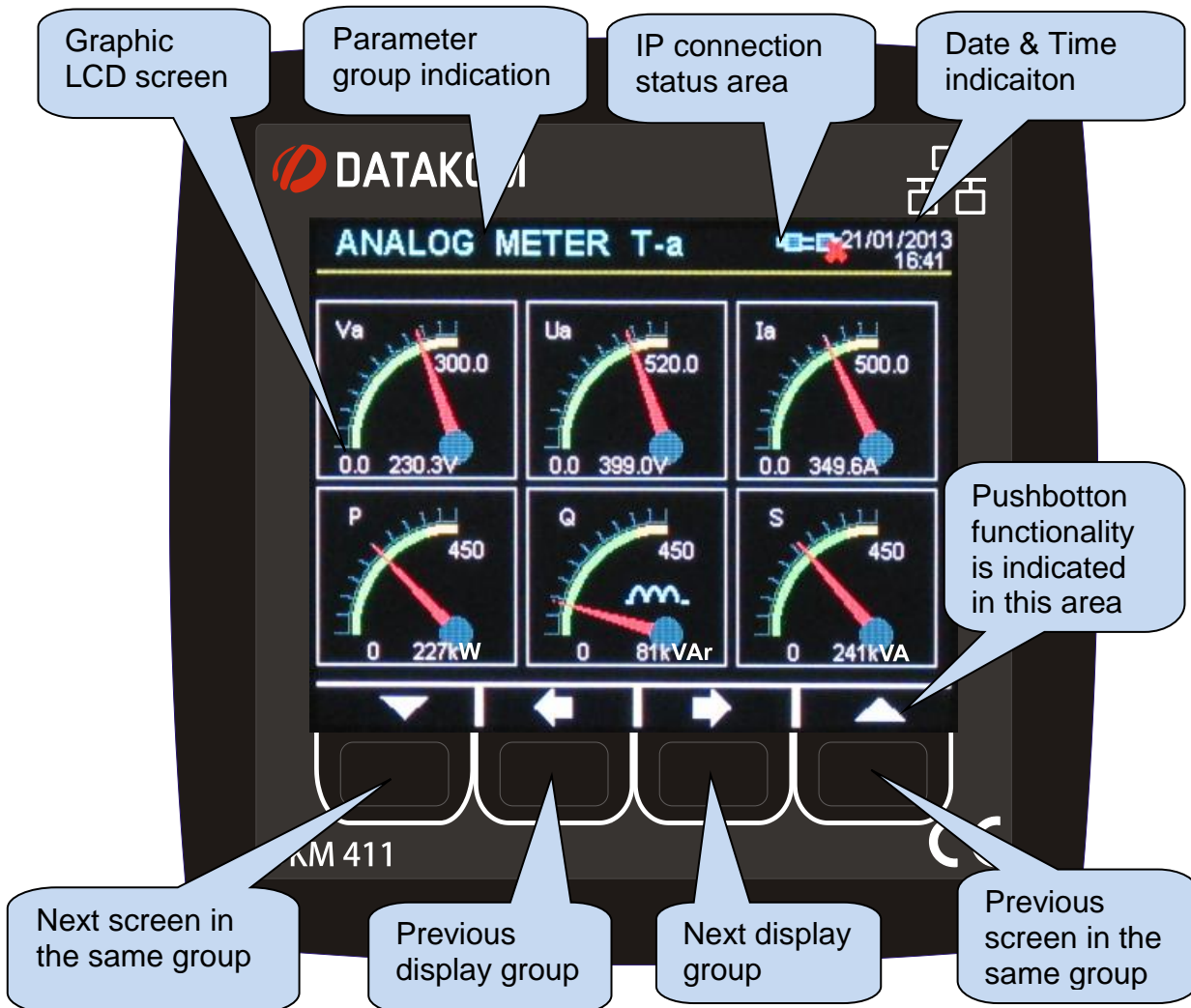

The front panel comprises a 320x240 pixels 3.5" color LCD display and 4 multi-function pushbutton keys.

The top section of the display is reserved for menu and status indications. This area displays the active menu, internet connection status and date-time information.

The function of the pushbuttons may vary following the active menu item and is dynamically indicated at the bottom section of the graphic display. Generally pushbuttons function as arrow keys to the 4 basic directions. Left-right arrow keys change the menu group. Up-down arrow keys navigate inside the same menu group.





8.2. PUSHBUTTON FUNCTIONS

BUTTON	FUNCTION
	Selects next display screen in the same display group. WHEN HELD PRESSED FOR 5 SECONDS: Makes the current display screen the default screen that comes up at power-on.
	Selects previous display group.
	Selects next display group.
	Selects previous display screen in the same display group. Resets the ALARM RELAY. If long-pressed, cancels all alarms.
	WHEN HELD PRESSED FOR 5 SECONDS: enters or exits PROGRAMMING mode.

8.3. DISPLAY SCREEN ORGANIZATION

The unit measures a large number of electrical parameters. The display of the parameters is organized as PARAMETER GROUPS and items in a group.

Navigation between different groups are made with  and  buttons.

Each depression of the  button will cause the display to switch to the next group of parameters. After the last group the display will switch to the first group.

Each depression of the  button will cause the display to switch to the previous group of parameters. After the first group the display will switch to the last group.

Navigation inside the same group is made with  and  buttons.

Each depression of the  button will cause the display to switch to the next parameter in the same group. After the last parameter the display will switch to the first parameter.

Each depression of the  button will cause the display to switch to the previous parameter in the same group. After the first parameter the display will switch to the last parameter.

Below is a basic list of parameter groups:

Digital measurements: Voltages, currents, frequency, kW, kVA, kVA_r, pf etc... Per phase and total/average measurements are available.

Scopemeter Display: This group display waveforms of voltages and currents as an oscilloscope. All Ph-N and Ph-Ph voltages as well as phase currents are available.

Displays offer 3-color graphics for the visualization of all phases together, or 2-color display for V-I pairs, allowing investigations per phase. This feature is especially useful to investigate waveform distortions due to harmonic loads.

Graphical Harmonic Analysis Results: This group displays harmonic composition of voltages and currents as bar_graphs, until the harmonic 31 (due to screen resolution limitations). Analysis of all Ph-N and Ph-Ph voltages as well as phase currents are available.

Displays offer 3-color graphics for the visualization of all phases together, or 2-color display for V-I pairs, allowing investigations per phase. This feature is especially useful to investigate harmonics caused by complex loads.

Numerical Harmonic Analysis Results: This group displays harmonic composition of voltages and currents with 0.1% resolution. All Ph-N and Ph-Ph voltages as well as phase currents are available. This feature is especially useful to investigate the harmonic effects caused by complex loads.

Phasor Diagram Display: This screen shows both graphically and digitally the angle relation between voltage and currents.

Analog Metering Display: This group displays various measured parameters as analog displays, 6 displays at once. Different combinations of per-phase or total values are available.

Compare Display: This group has 2 analog displays, with freely selectable channels for each one. The relation between 2 measured parameter may be visualized in an easy-to-see form.

Counters Display: This group shows various incremental power counters recorded in the unit.

Analog Clock Display: Shows date & time in an analog format. Provides also some system information screens and the company logo screen which is displayed at power-on.

Demand/Min/Max Display: This group shows current and power demand records, minimum recorded values of voltages, currents, frequency and power parameters and maximum recorded values of voltages, currents, frequency and power parameters.

User Screens: This group includes 4 display screens that may be freely configured by the user. Any display screen can be defined as the default screen. Thus the unit may be customized in a way to display only the required parameters only necessary information to the user.

Alarm Display: This group displays all existing alarms, one screen per alarm. When there is no more alarm to display it will show "END OF ALARM LIST".

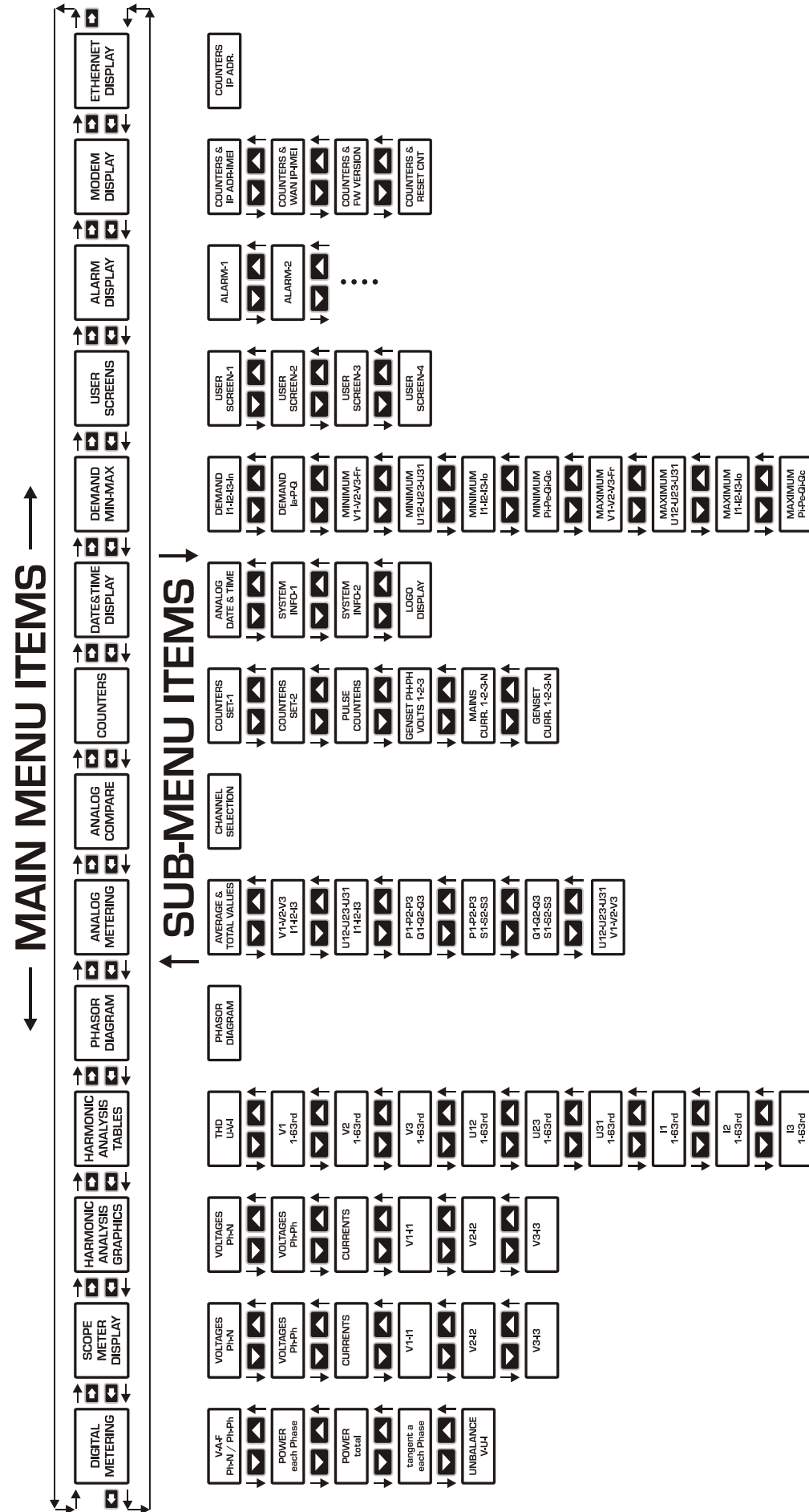

8.4. MEASURED PARAMETERS

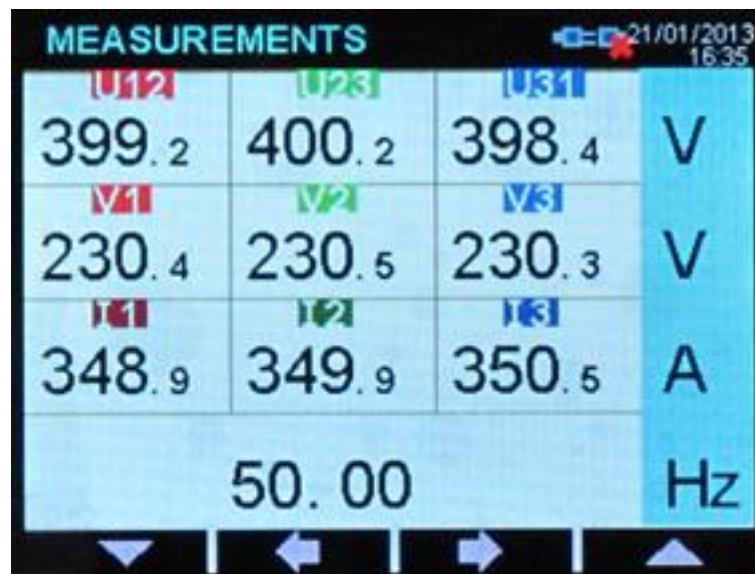

The unit performs a detailed set of AC measurements.

The list of measured parameters is below :

L1-N voltage	L1 active power (kW)
L2-N voltage	L2 active power (kW)
L3-N voltage	L3 active power (kW)
L1-L2 voltage	L1 reactive power (kVAr)
L2-L3 voltage	L2 reactive power (kVAr)
L3-L1 voltage	L3 reactive power (kVAr)
L1 current	L1 apparent power (kVA)
L2 current	L2 apparent power (kVA)
L3 current	L3 apparent power (kVA)
N current	L1 power factor (pf)
Frequency (Hz)	L2 power factor (pf)
Total Active Power	L3 power factor (pf)
Total Reactive Power	L1 tangent(teta) %
Total Apparent Power	L2 tangent(teta) %
Total Power Factor	L3 tangent(teta) %
Total tangent(teta) %	
Average Voltage	
Average Current	
Voltage Unbalance %	
Current Unbalance %	

The phasor diagram:

Phase angle L1 voltage
 Phase angle L2 voltage
 Phase angle L3 voltage
 Phase angle L1 current
 Phase angle L2 current
 Phase angle L3 current

Harmonic analysis channels:

L1-N voltage
 L2-N voltage
 L3-N voltage
 L1-L2 voltage
 L2-L3 voltage
 L3-L1 voltage
 L1 current
 L2 current
 L3 current
 Neutral Current

9. WAVEFORM DISPLAY & HARMONIC ANALYSIS

The unit features waveform display together with a precision harmonic analyzer for voltages and currents. Both phase to neutral and phase to phase voltages are available for analysis, thus 9 channels in total are possible.

Available channels are:

Volts: V1, V2, V3, U12, U23, U31

Currents: I1, I2, I3

Available display pages:

Voltages: V1-V2-V3

Voltages: U12-U23-U31

Currents: I1-I2-I3

V-I pairs: V1-I1, V2-I2, V3-I3

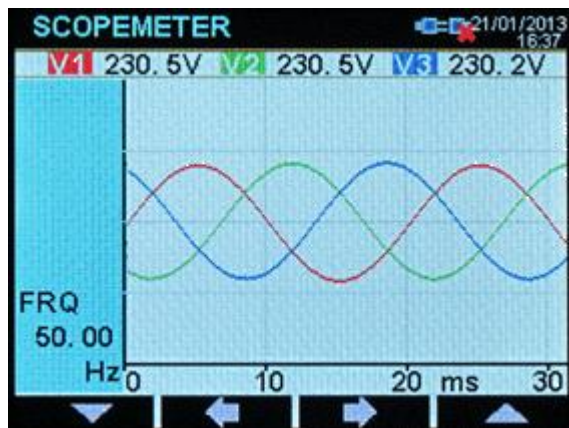

Waveform display of Ph-N voltages

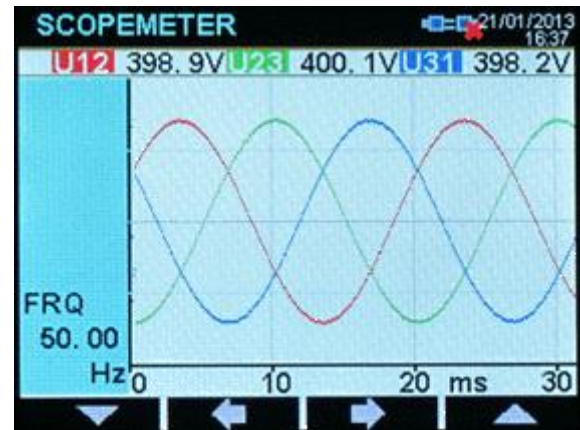

Waveform Display of Ph-Ph Voltages

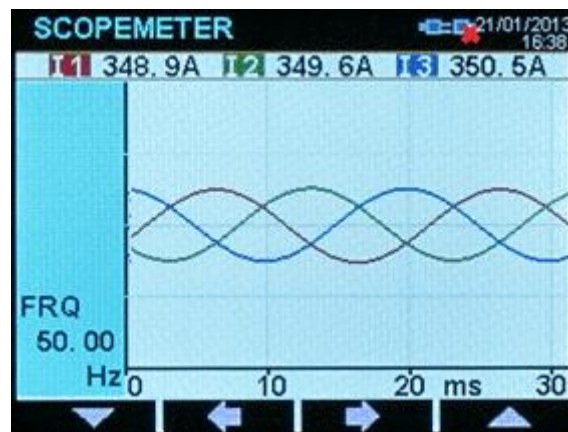

Waveform Display of Phase Currents

The waveform display memory is of 250 samples length and 13 bit resolution, with a sampling rate of 8192 s/s. Thus one cycle of a 50Hz signal is represented with 164 points. The vertical scale is automatically adjusted in order to avoid clipping of the signal.

The waveform display is updated twice a second. All channels may be scrolled with



The harmonic analyzer consists on a Fast Fourier Transform (FFT) algorithm which is run twice a second on all channels.

The sample memory is 1024 samples long and 13 bits resolution with a sampling rate of 8192 s/s.

The theory says that a periodic signal may have only odd multiples of the main frequency. Thus in a 50Hz network, harmonics will be found only at 150, 250, 350, 450 Hz etc...

The unit is able to analyze up to 3600Hz and up to 63rd harmonic, whichever is smaller. Thus in a 50Hz system all 63 harmonics will be displayed, but in a 60Hz system only 59 harmonics will come to the screen.

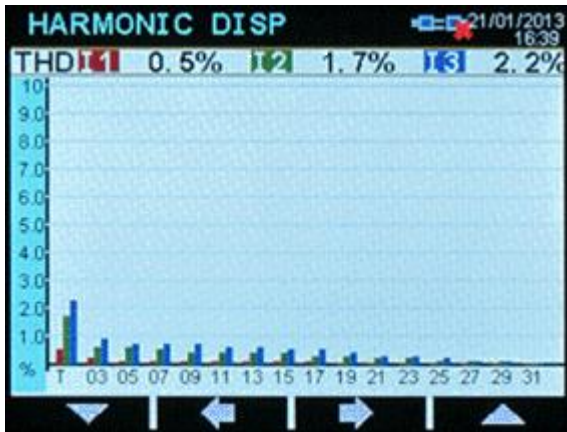

Graphical Harmonic Table



Alphanumeric Harmonics Table

Harmonics are represented by 2 different ways on the device display. The first one is a graphical representation allowing perception of the harmonic structure at a glance.

The second display is alphanumeric, thus all harmonics are displayed with 0.1% resolution in order to provide more accurate information.

On RainbowPlus program, harmonics and waveform are displayed on a single screen with more resolution.

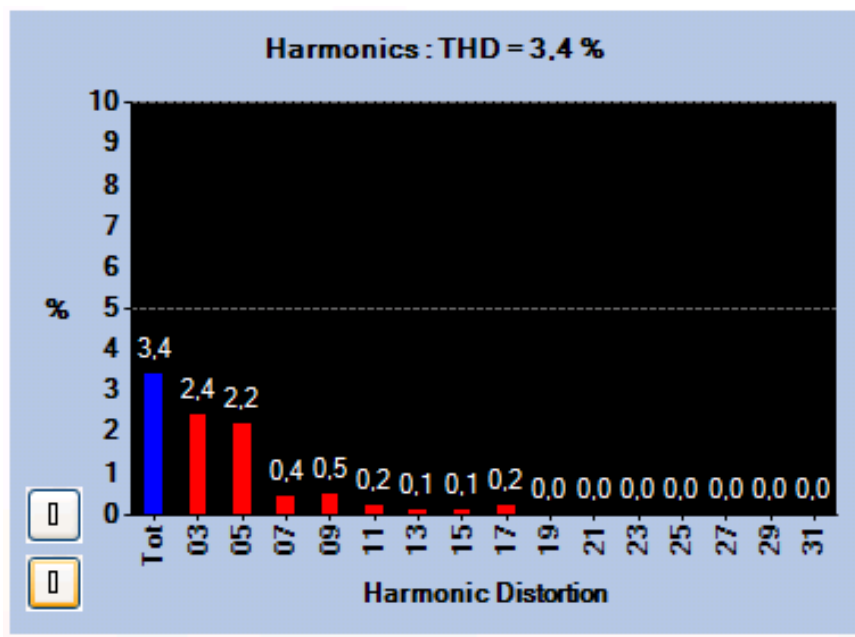

RainbowPlus Scada: Harmonic Analysis Display

10. PHASOR DIAGRAM

The unit offers a Phasor diagram display presenting the phasing of all voltage and current inputs.

The reference phase is the voltage input V1 (L1-N voltage). This is the long vertical segment drawn in red color.

The white arrow in the diagram shows the correct rotation direction. Usually in a 3 phase system, the voltage V2 (long segment in green color) is 120 degrees behind (lagging) the voltage V1.

The voltage V3 (long segment in blue color) will be 240 degrees behind V1.

The currents are represented with shorter and thicker segments. They may be lagging (inductive load) or leading (capacitive load) the related phase voltage. In our example below, currents are lagging by approximately 20 degrees. Thus our sample load is inductive.

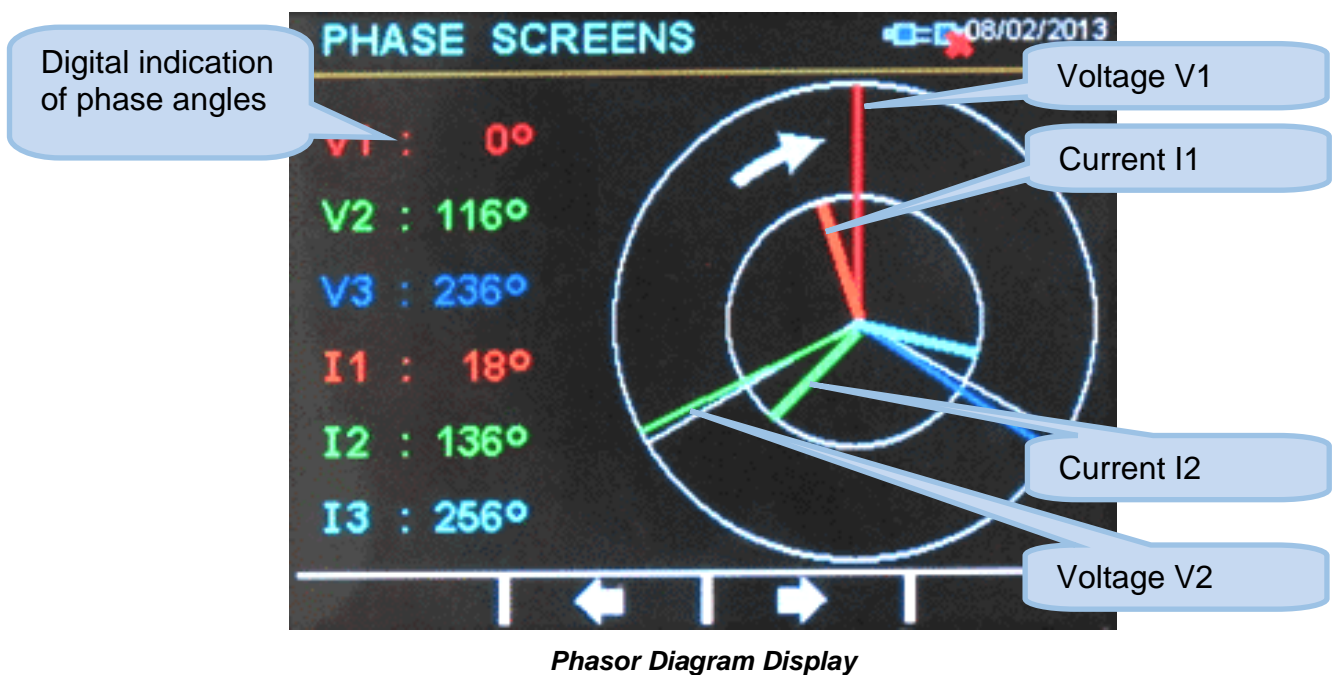

11. ANALOG DISPLAYS

Various analog displays are provided for the ease of reading.

Each analog display page consists of 6 gauges, presented in various combinations.

Yellow and green zones in gauges are directly picked up from warning and alarm levels, providing check-up at a glance.



12. COMPARING MEASUREMENTS

Comparison displays screen consists on two analog gauges, where any measured parameter may be visualized in each gauge. Therefore any couple of measurements may be compared visually.



13. USER CONFIGURABLE DISPLAY SCREENS



The device offers a powerful user screen design tool through programming menu. The user can freely design his own screen for the most specialized functionality. Any measured value may be set on the display, using 2 different possible font sizes.

The display has 6 lines of large characters or 12 lines of small characters. When small characters are used, 2 columns are permitted. The capacity of the screen therefore becomes 6 large size values or 24 small size values or any combination of them. Above is a sample user defined screen.

The device offers 4 independent user defined screens, totalizing the amount of possible parameters to 96 items.

User screen names are also editable for additional flexibility.



For more details about user screen configuration please review chapter CONFIGURING USER DISPLAY SCREENS at the PROGRAMMING section of this manual.

14. POWER COUNTERS & INCREMENTAL COUNTERS

Counter Label	Value	Unit
PIm1	00'009'843	1 kWh
PEx1	00'002'560	9 kWh
QIn1	00'004'366	8 kVArh
QCp1	00'008'758	3 kVArh

The unit provides a set of incremental counters for statistical purposes. These counters are stored in a non-volatile memory and retain their values even when power is off.

The unit offers two sets of counters. This is in order to enable the user totalize separately genset and mains counters. Counter sets can be switched with external signal, enabling sophisticated applications.

Incremental counters will count with external signal coming from digital inputs. Therefore external events may be counted and transmitted through internet.

The counters consist on:

- total imported kWh-1
- total exported kWh-1
- total kVArh inductive-1
- total kVArh capacitive-1
- incremental counter-1
- total imported kWh-2
- total exported kWh-2
- total kVArh inductive-2
- total kVArh capacitive-2
- incremental counter-2

15. DEMAND VALUES

Demand values are average values of measured parameters over a 15 minute period.

The unit starts a demand calculation period every 15 minutes (synchronized to the real time clock). The average values at the end of the period are compared with the demand registers, if higher, the new demand is stored into the register.

Demand registers are reset at the beginning of each month. Therefore demands are effective for the current month.

Demand registers are stored in a non-volatile memory and retain their values even when power is off.

Below demand registers are available:

- demand I1
- demand I2
- demand I3
- demand Ia (average current)
- demand active power
- demand reactive power.

16. MIN-MAX VALUES

Min-max values are based on instantaneous measurements. They have no averaging periods, therefore excessive values may be stored during short duration peak demands, like electric motor starts or inrush currents that flow at power-on.

During operation, the unit compares the instantaneous value with the storage registers, if higher, the new value is stored into the register.

Min-max registers are reset through programming mode. The related parameter is:

COUNTER/MIN/MAX>Restart Min/Max

Min-max registers are stored in a non-volatile memory and retain their values even when power is off.

For stability purposes, the min-max detection starts 5 seconds after power turns on.

Below min-max registers are available

- | | |
|-----------------------------------|-----------------------------------|
| -Min voltage L1-N | -Max voltage L1-N |
| -Min voltage L2-N | -Max voltage L2-N |
| -Min voltage L3-N | -Max voltage L3-N |
| -Min voltage L1-2 | -Max voltage L1-2 |
| -Min voltage L2-3 | -Max voltage L2-3 |
| -Min voltage L3-1 | -Max voltage L3-1 |
| -Min frequency | -Max frequency |
| -Min current I1 | -Max current I1 |
| -Min current I2 | -Max current I2 |
| -Min current I3 | -Max current I3 |
| -Min current Ia (average current) | -Max current Ia (average current) |
| -Min import active power | -Max import active power |
| -Min export active power | -Max export active power |
| -Min inductive reactive power | -Max inductive reactive power |
| -Min capacitive reactive power | -Max capacitive reactive power |

17. DISPLAYING EVENT LOGS

The unit features more than 400 event logs with date-time stamp and full snapshot of measured values at the moment that the event has occurred.

Stored values in an event record are listed below:

- event number
- event type / fault definition (see below for various event sources)
- date and time
- binary values of all alarm, input and output bits.
- Ph-N voltages: V1-V2-V3
- Ph-Ph voltages: U12-U23-U31
- Phase currents: I1-I2-I3
- frequency
- total active power (kW)
- total reactive power (kVAR)
- total apparent power (kVA)
- total power factor
- Total harmonic distortion: V1-V2-V3-U12-U23-U31-I1-I2-I3

Possible event sources are various. Every source can be individually enabled or disabled:

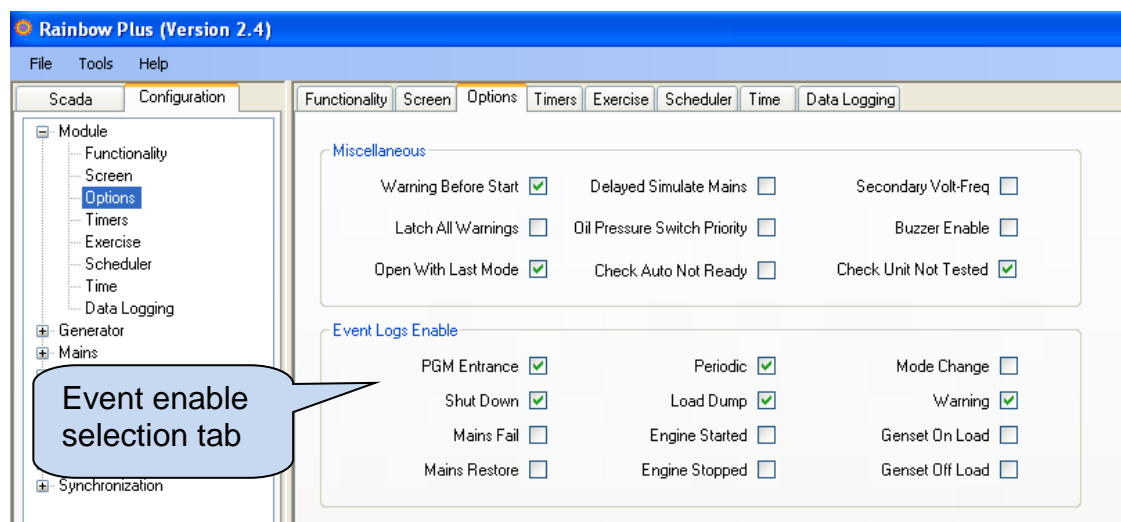

Program mode entrance event: recorded with the password level when program mode is entered.

Periodic event: recorded every 30 minutes when the engine is running, and every 60 minutes anyway.

Alarm events: recorded when the related fault condition occurs.

Input/output change events: recorded when the status of a digital input or output changes.

Power-on event: Recorded at each power on.

Event logs are displayed within the program mode menu. This is designed in order to reduce the interference of event logs with other measurement screens.

To **enter the event display**, press together with  and  buttons for 5 seconds.

When the program mode is entered, below password entry screen will be displayed.

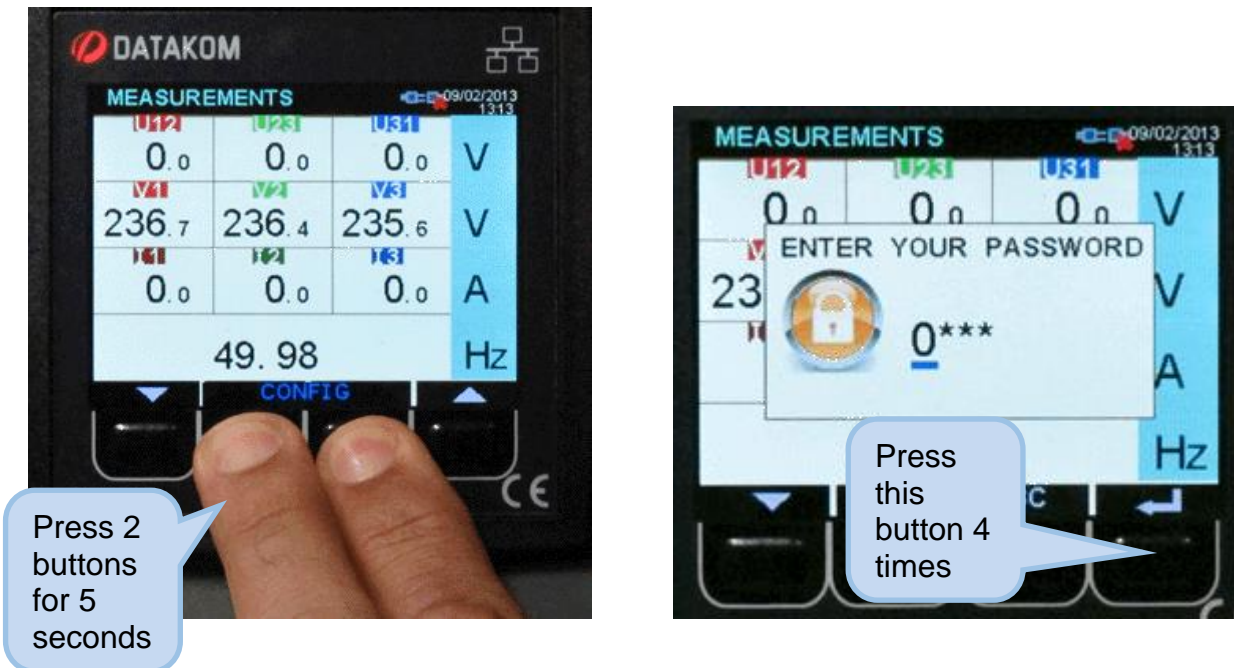

Skip the password entry screen by pressing the  button 4 times. The screen below left will come.

Press again the  button. The last stored event will open, as in the below-right picture.

The first page will display the event number, event type, fault type and date-time information.



When displaying event logs:

 button will display the next information in the same event

 button will display the same information of the previous event

 button will display the same information of the next event.

ESC button, when held pressed returns to the main event display screen.

18. PROTECTIONS AND ALARMS

The device is able to generate fault conditions on adjustable limits of measured parameters. Fault cases are considered under two categories, namely alarm and warnings:

- 1- **ALARMS:** These are the most important fault conditions.
- 2- **WARNINGS:** Less severe fault conditions.

Occurring fault conditions will cause the related function to become active. These conditions are displayed in the ALARM LIST screen. Conditions may also be assigned to relay outputs, activating external circuitry.



If a fault condition occurs, the display will automatically switch to the ALARM LIST page.

Alarms operate in a first occurring basis:

- If an alarm is present, following alarms and warnings will not be accepted,
- If a warning is present, following warnings will not be accepted.



In case of fault condition, if the  button is pressed, the alarm output will be deactivated; however the existing alarms will persist.

Alarms may be of **LATCHING** type following programming.

For latching alarms, even if the alarm condition is removed, the alarms will stay on and disable the operation of the genset.



Existing alarms may be canceled by long-pressing the  button.

Most of the alarms have programmable trip levels. See the programming chapter for adjustable alarm limits.

19. PROGRAMMING

The program mode is used to adjust timers, operational limits and the configuration of the unit.

Although a free PC program is provided for programming, every parameter may be modified through the front panel, regardless of the operating mode.

When modified, program parameters are automatically recorded into a non-erasable memory and take effect immediately.

The program mode will not affect the operation of the unit. Thus programs may be modified anytime.



19.1. ENTERING THE PROGRAMMING MODE

To **enter the program mode**, press together with  and  buttons for 5 seconds.

When the program mode is entered, below password entry screen will be displayed.



A 4 digit password must be entered using with ,  and  buttons.

The ,  buttons modify the value of the current digit. The  button steps to the next digit.

The unit supports 3 password levels. The level_1 is designed for field adjustable parameters. The level_2 is designed for factory adjustable parameters. The level_3 is reserved. It allows recalibration of the unit.

The password level-1 is factory set to '1234' and the password level-2 is factory set to '9876'.





Passwords are not front panel adjustable.

If a wrong password is entered, the unit will still allow access to the program parameters, but in read-only mode.



If password "0000" is entered, only EVENT LOG file will be available.

19.2. NAVIGATING BETWEEN MENUS

The program mode is driven with a two level menu system. The top menu consists on program groups and each group consists on various program parameters.

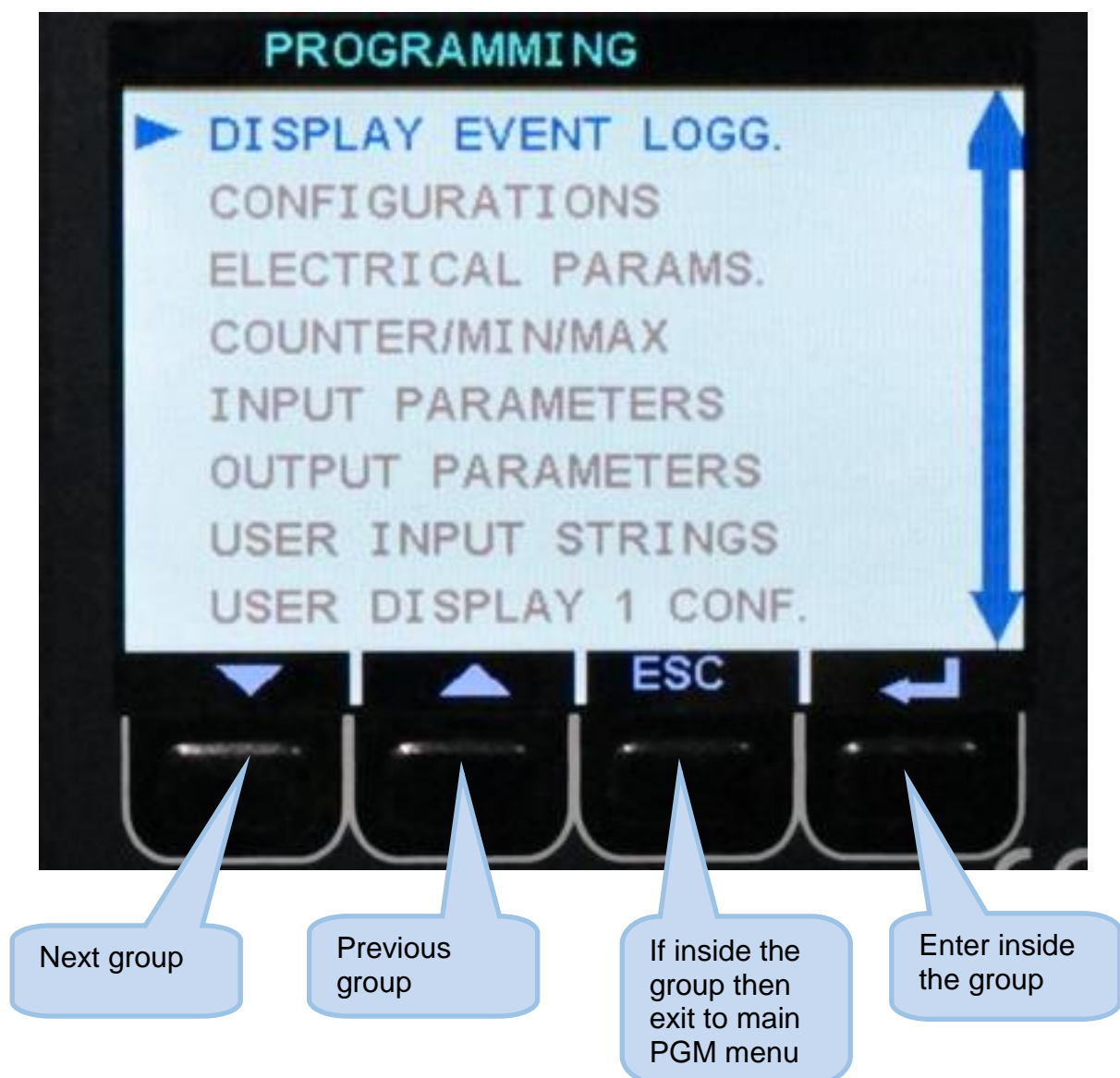
When program mode is entered, a list of available groups will be displayed. Navigation between different groups are made with  and  buttons. Selected group is shown in a different color. In order to enter inside a group, please press  button. In order to exit from the group to the main list please press **ESC** button.





Navigation inside a group is made also with  and  buttons.

A list of available parameters will be displayed. The selected parameter is shown in a different color.

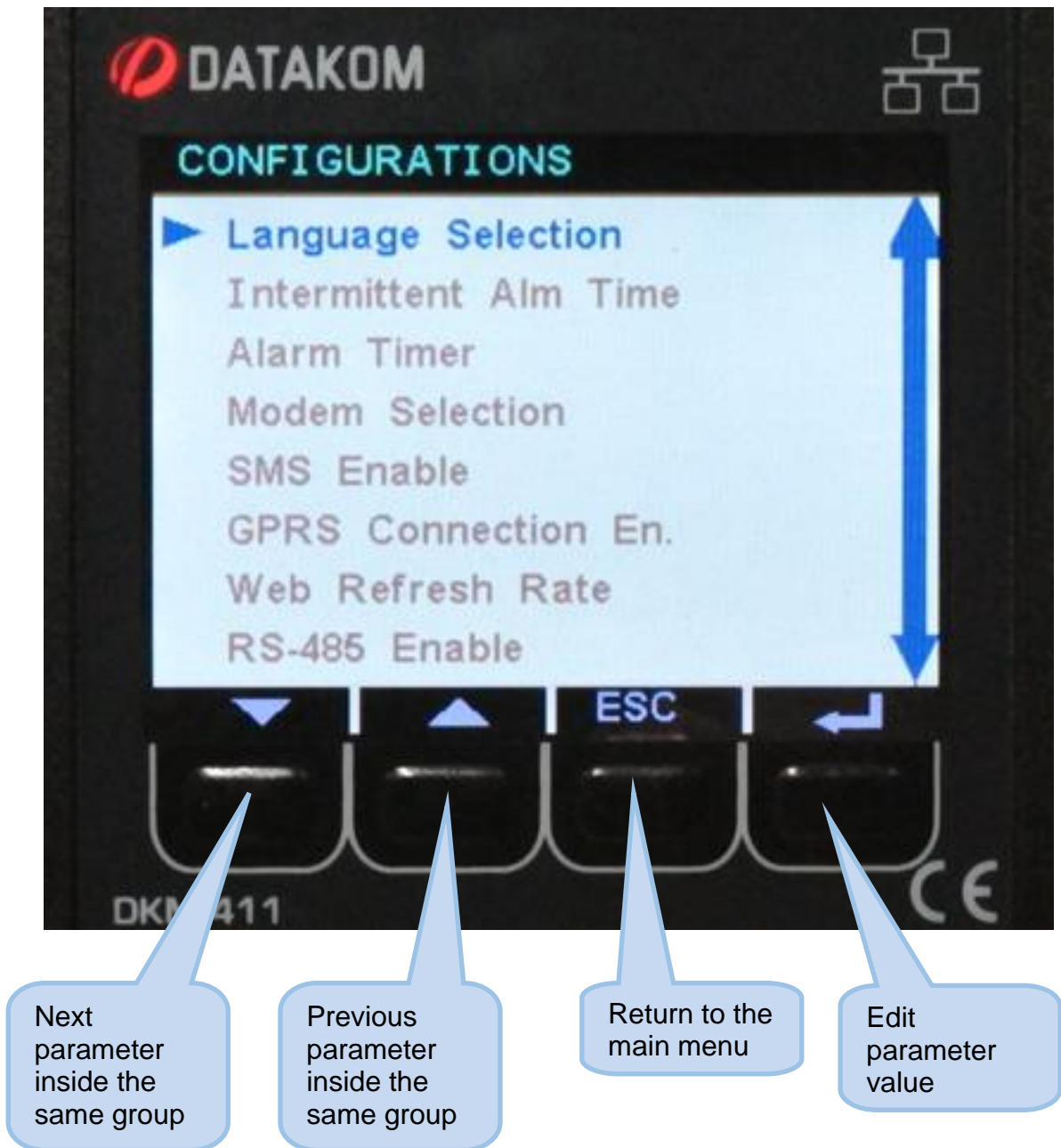
In order to display/change the value of this parameter, please press  button



19.3. MODIFYING PARAMETER VALUE

Parameter value may be increased and decreased with  and  buttons. If these keys are held pressed, the program value will increase/decrease at a faster speed.

When a program parameter is modified, it is automatically saved in memory.

If  button is pressed, next parameter will be displayed.

If  button is pressed, then the list of parameters in this group will be displayed.

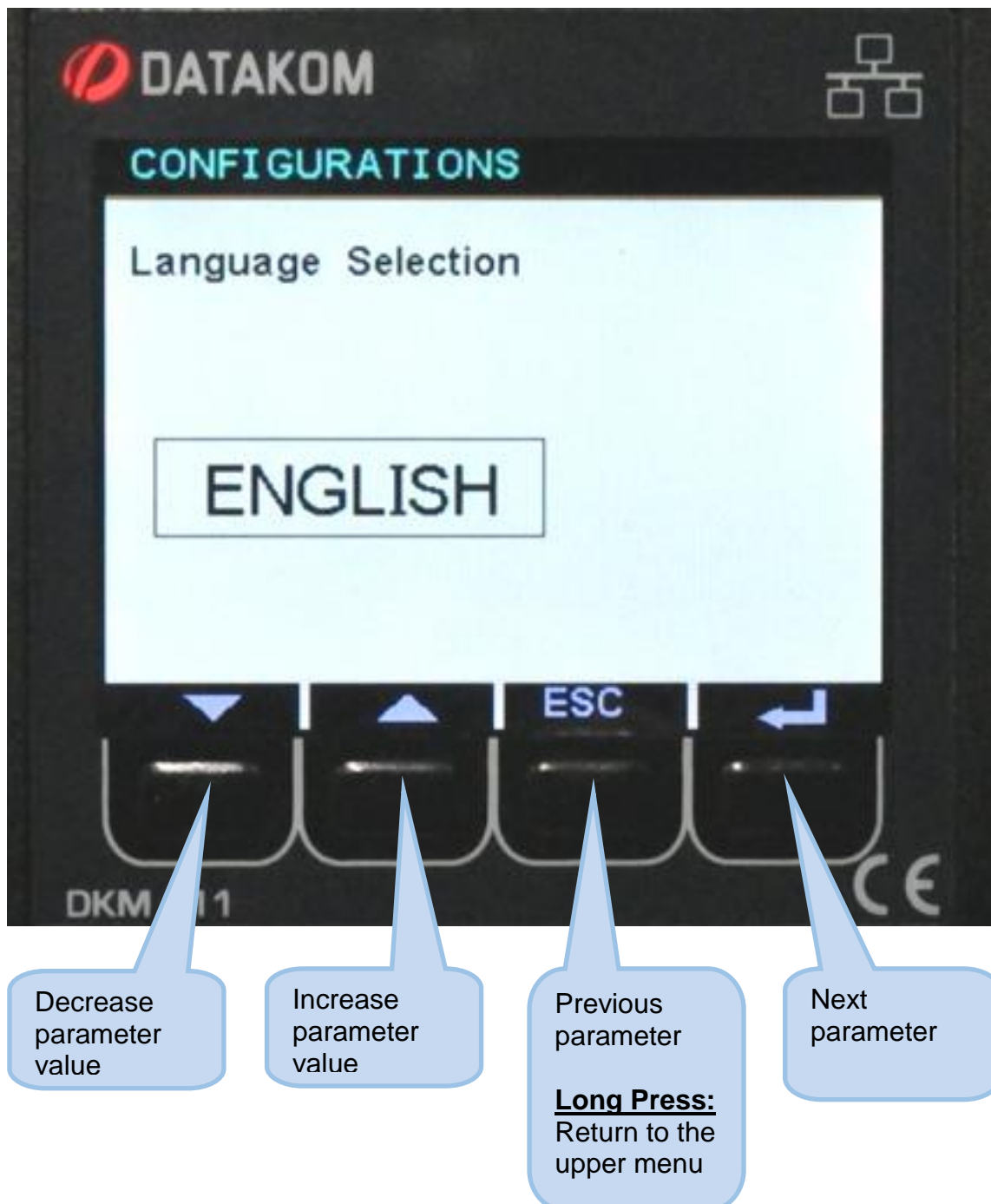

19.4. PROGRAMMING MODE EXIT

To exit the program mode press **▲** and **ESC** buttons together during 5 seconds.
If no button is pressed during 2 minutes the program mode will be cancelled automatically.



19.5. RESETTING TO FACTORY SET PARAMETERS

In order to resume to the factory set parameter values:

- Enter programming mode with password "9876",
- press  button until displaying the "RETURN TO FACTORY SET" menu.

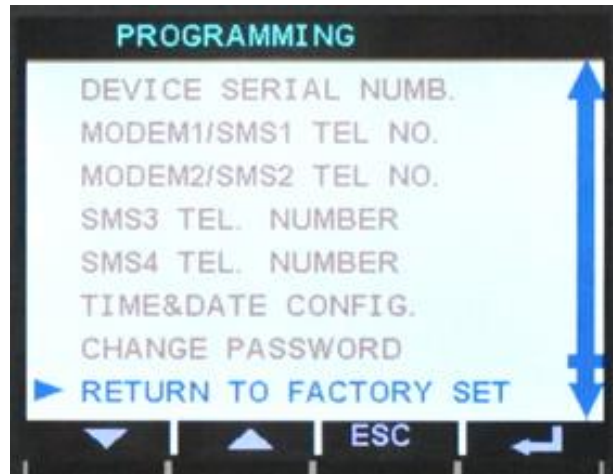

- press  button. The factory set dialog box will appear.

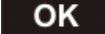

- press  BUTTON. Factory set values will be reprogrammed to the parameter memory.



It is not possible to restore previous parameters.

20. PROGRAM PARAMETER LIST

20.1. CONTROLLER CONFIGURATION GROUP

Parameter Definition	Unit	Min	Max	Factory Set	Description
LCD Backlight	%	3	100	100	The intensity of the LCD back light.
Language	-	0	1	0	0: English language selected. 1: Local language selected. This language may be downloaded.
Intermittent Alarm Timer	-	0	255	1	0: continuous alarm (horn) output 1..255: intermittent alarm output period in seconds
Alarm Relay Timer	sec	0	120	60	The period during which the ALARM relay is active. If the period is set to 0, the alarm output is constantly on.
Status Prompt Window Enable	-	0	1	0	0: Status prompts disabled 1: Status prompts enabled
Modem Selection	-	0	1	0	0: not used 1: external GSM Datakom modem
SMS Enable	-	0	1	0	0: SMS messages disabled 1: SMS messages enabled
GPRS Connection Enable	-	0	1	0	0: GPRS disabled 1: GPRS enabled
Web Refresh Rate	sec	0	240	5	The unit will refresh the web page with this interval.
RS-485 Enable	-	0	1	1	0: RS-485 port disabled 1: RS-485 port enabled
Modbus Address	-	0	240	1	Modbus controller identity used in Modbus communication.
RS-485 Baud Rate	bps	2400	115200	9600	This is the data rate of the RS-485 Modbus port.
Ethernet Enable	-	0	1	1	0: ethernet port disabled 1: ethernet port enabled
Real Time Clock Adjust	-	0	255	117	This parameter trims precisely the real time clock circuit. Values from 0 to 63 speed up the clock with 0.25sec/day steps. Values from 127 to 64 slow down the clock with 0.25sec/day steps.
Periodic event time	min	1	65000	60	This parameter adjusts the period for periodic event logging.
Intermittent Alarm Relay Enable	-	0	1	0	0: steady alarm output 1: intermittent alarm output
SMS on Output Change	-	0	1	0	This parameter controls SMS sending when any output has changed state. No warnings generated. 0: no SMS on output change 1: SMS sent on output change
Alarm Event Log Enable	-	0	1	1	0: No event logging on alarm 1: Event logged on alarm condition
Warning Event Log Enable	-	0	1	1	0: No event logging on warning 1: Event logged on warning condition

20.1. CONTROLLER CONFIGURATION GROUP (continued)

Parameter Definition	Unit	Min	Max	Factory Set	Description
Output Event Log Enable	-	0	1	1	0: No event log on output change 1: Event logged on output change
Input Event Log Enable	-	0	1	1	0: No event logging on input change 1: Event logged on input change
Power-on Event Log Enable	-	0	1	1	0: No event logging at power-on 1: Event logged on power-on
Periodic Event Log Enable	-	0	1	1	0: No periodic event logging 1: Event logged periodically
Programming Event Log Enable	-	0	1	0	0: No event logging at program mode entrance 1: Event logged on program mode entrance
SMS on IP Change	-	0	1	0	0: no SMS on IP address change 1: SMS sent on IP address change
E-mail on IP Change	-	0	1	0	0: no e-mail on IP change 1: e-mail sent on IP change
SMS Commands Enabled	-	0	1	0	0: SMS commands not accepted 1: SMS commands are accepted but from listed telephone numbers only.
Ping Period	sec	30	900	120	The unit will check the availability of the internet connection with this interval.
Rainbow Scada Refresh Rate	sec	0	65535	60	The unit will update the distant monitoring terminal with this rate.
Rainbow Scada Address-1 Port	-	0	65535	90	This is the port number of the first monitoring terminal address.
Rainbow Scada Address-2 Port	-	0	65535	90	This is the port number of the second monitoring terminal address.
Web Server Port	-	0	65535	80	This is the port number of the internal web server. The unit will answer queries to this port only.
Modbus TCP/IP Port	-	0	65535	502	Internal Modbus TCP/IP server's port number. The unit answers Modbus requests to this port only.
SMTP Port	-	0	65535	587	Port number used for e-mail sending.
Log Record Period	sec	10	3600	60	This parameter adjusts the data logging frequency to USB Flash memories. Frequent recording will require more memory capacity. With a period of 60 seconds, 263MB is consumed per year.
LCD Backlight Delay	min	0	1440	60	If no button is pressed during that period, then the unit will reduce the LCD screen backlight intensity in for economy.
Flashing Relay ON Timer	min	0	1200	0	Flashing relay ON state duration timer.
Flashing Relay OFF Timer	min	0	1200	0	Flashing relay OFF state duration.

20.2. ELECTRICAL PARAMETERS GROUP

Parameter Definition	Unit	Min	Max	Factory Set	Description
Current Transformer Configuration	Amp	1/1 5/5	2'000/1 10'000/5	500/5	This is the rated value of current transformers. All transformers must have the same rating. The secondary of the transformer will be 5 Amps.
Voltage Transformer Ratio	V/V	1.0	5'000.0	1.0	This is the voltage transformer ratio. This value will multiply all voltage and power readings. If transformers are not used, the ratio should be set to 1.0
Alarm Mute Time	sec	0	255	20	When the non-latching alarm goes off, the alarm relay will be deactivated after this period.
Phase Order Check Enable	-	0	1	0	0: phase order checking disabled 1: if phase order is faulty, then a warning is given.
Low Voltage Alarm Limit	V	0	65500	0	If one of the Ph-N voltages goes under this limit, this will generate a LOW VOLTAGE alarm.
High Voltage Alarm Limit	V	0	65500	0	If one of the Ph-N voltages goes over this limit, this will generate a HIGH VOLTAGE alarm.
Voltage Alarm Duration	sec	0	255	30	When voltages are outside limits, the voltage alarm will occur after this timer.
Voltage Alarm Lock Enable	-	0	1	0	0: Voltage alarm disappears when voltages are within limits 1: Voltage alarm persists until manually reset.
Frequency Low Alarm Limit	Hz	0	400	0	If the frequency goes under this limit, this will generate a LOW FREQUENCY alarm.
Frequency High Alarm Limit	Hz	0	400	0	If the frequency goes over this limit, this will generate a HIGH FREQUENCY alarm.
Frequency Alarm Duration	sec	0	255	30	When the frequency is outside limits, the frequency alarm will occur after this timer.
Frequency Alarm Lock Enable	-	0	1	0	0: Frequency alarm disappears when frequency is within limits 1: Frequency alarm persists until manually reset.
Active Power Low Alarm Limit	kW	0	9'999	0	If the active power goes under this limit, this will generate a LOW ACTIVE POWER alarm.
Active Power High Alarm Limit	kW	0	9'999	0	If the active power goes over this limit, this will generate a HIGH ACTIVE POWER alarm.
Active Power Alarm Duration	sec	0	255	30	When the active power is outside limits, the active power alarm will occur after this timer.
Active Power Alarm Lock Enable	-	0	1	0	0: Active power alarm disappears when active power is within limits 1: Active power alarm persists until manually reset.

20.2. ELECTRICAL PARAMETERS GROUP (continued)

Reactive Capacitive Power High Alarm Limit	kVAr	0	9'999	0	If the reactive capacitive power goes over this limit, this will generate a HIGH REACTIVE POWER alarm.
Reactive Inductive Power High Alarm Limit	kVAr	0	9'999	0	If the reactive inductive power goes over this limit, this will generate a HIGH REACTIVE POWER alarm.
Reactive Power Alarm Duration	sec	0	255	30	When the reactive power is outside limits, the active power alarm will occur after this timer.
Reactive Power Alarm Lock Enable	-	0	1	0	0: reactive power alarm disappears when the reactive power is within limits 1: reactive power alarm persists until manually reset.
Reactive Capacitive Power High Alarm Limit	kVAr	0	9'999	0	If the reactive capacitive power goes over this limit, this will generate a HIGH REACTIVE POWER alarm.
Capacitive Power Factor alarm Limit	-	0	0.999	0	If the power factor is capacitive and under this limit, then an CAPACITIVE PF alarm will occur.
Inductive power factor alarm Limit	-	0	0.999	0	If the power factor is inductive and under this limit, then an INDUCTIVE PF alarm will occur.
Power factor alarm Duration	sec	0	255	30	When the power factor is outside limits, the POWER FACTOR alarm will occur after this timer.
Power Factor Alarm Lock Enable	-	0	1	0	0: compensation alarm disappears when the power factor is within limits 1: compensation alarm persists until manually reset.
Current High Alarm Limit	A	0	5'000	0	If the current goes over this limit, this will generate a HIGH CURRENT alarm.
Current High Alarm Duration	sec	0	255	30	When the active power is outside limits, the active power alarm will occur after this timer.
Current High Alarm Lock Enable	-	0	1	0	0: High current alarm disappears when current is below limit 1: High current alarm persists until manually reset.
THD-V High Alarm Limit	%	0	50	0	If the THD of any voltage channel goes over this limit, this will generate a HIGH THD-V alarm.
THD-V t High Alarm Duration	sec	0	255	30	When the THD-V goes over the limit, the HIGH THD-V alarm will occur after this timer.
THD-V High Alarm Lock Enable	-	0	1	0	0: HIGH THD-V alarm disappears when the THD-V is below limit 1: HIGH THD-V alarm persists until manually reset.

20.2. ELECTRICAL PARAMETERS GROUP (continued)

THD-I High Alarm Limit	%	0	50	0	If the THD of any current channel goes over this limit, this will generate a HIGH THD-I alarm.
THD-I High Alarm Duration	sec	0	255	30	When the THD-I goes over the limit, the HIGH THD-I alarm will occur after this timer.
THD-I High Alarm Lock Enable	-	0	1	0	0: HIGH THD-I alarm disappears when the THD-I is below limit 1: HIGH THD-I alarm persists until manually reset.
Voltage Unbalance Alarm Limit	%	0	50	0	If the Voltage Unbalance goes over this limit, this will generate a VOLTAGE UNBALANCE alarm.
Voltage Unbalance Alarm Duration	sec	0	255	30	When Voltage Unbalance goes over the limit, the VOLTAGE UNBALANCE alarm will occur after this timer.
Voltage Unbalance Alarm Lock Enable	-	0	1	0	0: Voltage Unbalance alarm disappears when the Voltage Unbalance is below limit 1: Voltage Unbalance alarm persists until manually reset.
Current Unbalance Alarm Limit	%	0	50	0	If the Current Unbalance goes over this limit, this will generate a CURRENT UNBALANCE alarm.
Current Unbalance Alarm Duration	sec	0	255	30	When Current Unbalance goes under the limit, the CURRENT UNBALANCE alarm will persist during this timer.
Current Unbalance Alarm Lock Enable	-	0	1	0	0: Current Unbalance alarm disappears when the Current Unbalance is below limit 1: Current Unbalance alarm persists until manually reset.
kW pulse Duration	Mili-sec	1	10'000	100	This is the pulse length of the kW/kVAr pulses.
Mains Connection Topology	-	0	7	5	This is the connection topology of mains voltages and CTs. Detailed explanations are given in the chapter: "TOPOLOGIES". 0: 3 phase, 4 wire star 1: single phase, 2 wire 2: 2 phase, 3 wire L1-L2 3: 3 phase, 3 wire 4: 3 phase, 4 wire delta 5: 3 phase, 3 wire, 2CTs L1-L2 6: 3 phase, 3 wire, 2CTs L1-L3

20.3. COUNTERS MIN/MAX PARAMETERS GROUP

Restart Min/Max	-	0	1	0	When this parameter is set to 1, then MIN/MAX values are reset.
Set Meter1 (kWh1-Import) Value	-	0	65'535	0	The counter value can be adjusted with this parameter.
Set Meter2 (kWh1-Export) Value	-	0	65'535	0	The counter value can be adjusted with this parameter.
Set Meter3 (kVArh1-Inductive) Value	-	0	65'535	0	The counter value can be adjusted with this parameter.
Set Meter4 (kVArh1-Capacitive) Value	-	0	65'535	0	The counter value can be adjusted with this parameter.
Set Meter6 (kWh2-Import) Value	-	0	65'535	0	The counter value can be adjusted with this parameter.
Set Meter7 (kWh2-Export) Value	-	0	65'535	0	The counter value can be adjusted with this parameter.
Set Meter8 (kVArh2-Inductive) Value	-	0	65'535	0	The counter value can be adjusted with this parameter.
Set Meter9 (kVArh2-Capacitive) Value	-	0	65'535	0	The counter value can be adjusted with this parameter.

20.4. DIGITAL INPUT CONFIGURATION



The unit has 2 digital inputs. Only parameters of one input are explained below. Other input have identical parameter set.

The input name is freely programmable, thus the input can be adapted to any functionality through programming.



The input name entry is made through RainbowPlus program only.

Each input has below programmable parameters:

Parameter Definition	Unit	Min	Max	Factory Set	Description
Latching	-	0	1		0: non-latching. The fault disappears when cause is removed. 1: latching. The fault persists even if the cause is removed. Requires manual reset.
Action	-	0	2		0: alarm 1: warning 2: no fault condition from this input.
Response delay	-	0	3		0: No delay (0.0s) 1: Delayed (0.1sec) 2: Delayed (0.2sec) 3: Delayed (0.5sec) 4: Delayed (1sec) 5: Delayed (2sec) 6: Delayed (5sec) 7: Delayed (10sec)
Sampling	-	0	0		0: always
Contact type	-	0	1		0: Normally open 1: Normally closed
Input Function	-	0	99		Selects between predefined input functions. Selected input name is displayed in the line below. If this parameter is set to 0 then the input name string can be freely entered.

INPUT FUNCTION LIST

Number	Function	Description
00	User Function 1	User defined function.
01	User Function 2	User defined function.
02	User Function 3	User defined function.
03	User Function 4	User defined function.
04	User Function 5	User defined function.
05	User Function 6	User defined function.
06	User Function 7	User defined function.
07	User Function 8	User defined function.
08	User Function 1	User defined function.
09	Reset Input Counter 1	Resets digital counter 1
10	Increment Input Counter 1	Increments digital counter 1
11	Reset Input Counter 2	Resets digital counter 2
12	Increment Input Counter 2	Increments digital counter 2
13	Switch Counter set	Changes the counter set used. (mains and genset for example)
14	Alarm Mute	Resets alarm output.

20.5. OUTPUT CONFIGURATION

The parameters below define the functions of relay outputs. The unit has 2 relay outputs. Each relay has programmable functions, selected from a list.

OUTPUT FUNCTION LIST

Number	Function	Description
00	Horn	Alarm relay output. Turns off automatically when timer expired.
01	Flashing Relay	Bistable relay output. Periodically activates/deactivates with programmed interval.
02	Phase Order Failure	Active when the phase order is reversed.
03	Voltage Fail	Active if at least one voltage is outside limits.
04	Voltage OK	Active if all voltages are within limits
05	Internal alarm	Active if any measurements based alarm exists
06	Input alarm	Active if any alarm caused by digital inputs exists
07	Warning	Active if any warning exists
08	Internal or Input alarm	Active if any alarm exists
09	kWh tick	kWh tick pulse output. Pulse length is programmable.
10	kVArh tick	kVArh tick pulse output. Pulse length is programmable.
11	Low Voltage Alarm	Active if at least one voltage is below low limit.
12	High Voltage Alarm	Active if at least one voltage is above high limit.
13	Low Frequency Alarm	Active if the frequency is below low limit.
14	High Frequency Alarm	Active if the frequency is above high limit.
15	Frequency Alarm	Active if the frequency is outside of limits.
16	Low Active Power	Active if the total kW is below low limit.
17	High Active Power	Active if the total kW is above high limit.
18	Active Power Alarm	Active if the kW is outside of limits.
19	Capacitive Reactive Power	Active if the capacitive reactive power is above high limit.
20	Inductive Reactive	Active if the inductive reactive power is above high limit.
21	Reactive Power Alarm	Active if capacitive or inductive reactive power is above limits.
22	Capacitive PF alarm	Active is the capacitive PF value is below limit.
23	Inductive PF alarm	Active is the inductive PF value is below limit.
24	PF alarm	Active if capacitive or inductive PF is below limits.
25	High Current Alarm	Active if at least one phase current is above limit.
26	THD-V Alarm	Active if at least one voltage THD is above limit.
27	THD-I Alarm	Active if at least one phase current THD is above limit.
28	THD Alarm	Active if any THD is above limit.
29	Voltage Unbalance	Active if the voltage unbalance is above limit.
30	Current Unbalance	Active if the current unbalance is above limit.
31	Unbalance Alarm	Active if the voltage or current unbalance is above limit.
32-39	User Input Alarm 1...8	Active when the related user defined function is active.
40-43	Button 1...4 Simulation	Active when related pushbutton is pressed.
44-45	Input 1...2 Simulation	Active if signal received from related input.

20.6. USER INPUT STRINGS

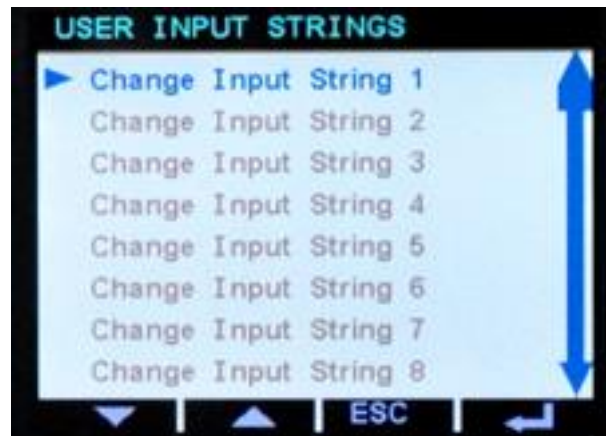

The device has several user defined strings that are used in measurement presentation or fault localization.

Number	Function	Description
00-07	Input Strings	These are function names associated with digital inputs.
08-11	User Screen Strings	These 4 strings appear at the top of 4 user configurable display screens. (explained later in this document).

20.7. CONFIGURING USER DISPLAY SCREENS

The device offers 4 user configurable display screens capable of presenting all available measurements in 2 different sizes.

These screens can be configured as the default screen, therefore the user can transform the unit into a specialized measurement instrument tailored on specific needs.



Select **USER DISPLAY x CONFIG** from the programming menu. Then press  button.



This screen will come. Remark the "1" at the upper left corner of the screen. This 1 shows that the selected parameter will be displayed in size "1" (small size).

Use  and  buttons to change the size of the display. "2" indicates large size.

Then press  button.



The parameter selection list will come. A list of all possible parameters is at the following page.

Use  and  buttons to select the required parameter then press  button.

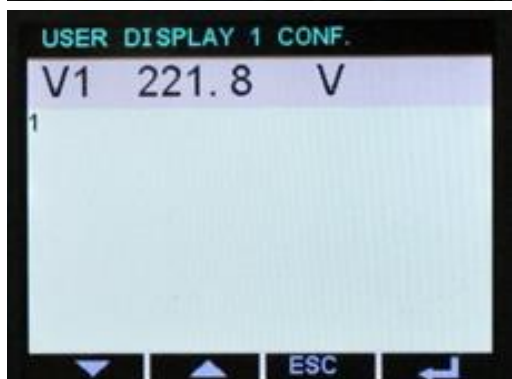

The parameter will be moved into the display screen.

Now the next display parameter can be programmed.

Repeat above 2 steps to add new parameters to the display.

When finished, long press  button in order to store the new screen.



The screen header is also programmable through "USER INPUT STRINGS" menu.

A sample user screen

LIST OF SELECTABLE PARAMETERS

L1-N Voltage	THD L1-N Voltage	Maximum L2-3 Voltage
L2-N Voltage	THD L2-N Voltage	Maximum L3-1 Voltage
L3-N Voltage	THD L3-N Voltage	Maximum I1 Current
L1-2 Voltage	THD L1-2 Voltage	Maximum I2 Current
L2-3 Voltage	THD L2-3 Voltage	Maximum I3 Current
L3-1 Voltage	THD L3-1 Voltage	Maximum Ia Average Current
L1 Current	THD L1 Current	Maximum Frequency
L2 Current	THD L2 Current	Maximum kW Import
L3 Current	THD L3 Current	Maximum kW Export
Neutral Current	THD Neutral Current	Maximum kVAr Inductive
L1 Active Power	Demand I1 Current	Maximum kVAr Capacitive
L2 Active Power	Demand I2 Current	Input Counter 1
L3 Active Power	Demand I3 Current	Input Counter 2
Total Active Power	Demand Ia Average Current	Average L-N Voltage
L1 Reactive Power	Demand kW	Average L-L Voltage
L2 Reactive Power	Demand kVAr	Average L-N Current
L3 Reactive Power	Minimum L1-N Voltage	L1 Q/P ratio
Total Reactive Power	Minimum L2-N Voltage	L2 Q/P ratio
L1 Apparent Power	Minimum L3-N Voltage	L3 Q/P ratio
L2 Apparent Power	Minimum L1-2 Voltage	Total Q/P ratio
L3 Apparent Power	Minimum L2-3 Voltage	Voltage Unbalance Ratio
Total Apparent Power	Minimum L3-1 Voltage	Current Unbalance Ratio
L1 Power Factor	Minimum I1 Current	Keep Blank
L2 Power Factor	Minimum I2 Current	
L3 Power Factor	Minimum I3 Current	
Total Power Factor	Minimum Ia Average Current	
Frequency	Current	
Import Power 1 Counter	Minimum Frequency	
Export Power 1 Counter	Minimum kW Import	
Inductive Reactive Power 1 Counter	Minimum kW Export	
Capacitive Reactive Power 1 Counter	Minimum kVAr Inductive	
Import Power 2 Counter	Minimum kVAr Capacitive	
Export Power 2 Counter	Maximum L1-N Voltage	
Inductive Reactive Power 2 Counter	Maximum L2-N Voltage	
Capacitive Reactive Power 2 Counter	Maximum L3-N Voltage	
L2 Power Factor	Maximum L1-2 Voltage	
L3 Power Factor		
Total Power Factor		

20.8. SITE-ID STRING

The site identity string is designed to identify the current device.

This is the site Id string sent at the beginning of SMS messages, e-mails and web page headers for the identification of the device sending the message. Any 20 character string may be entered.

20.9. DEVICE SERIAL NUMBER

The engine serial number string is designed to identify the current device.

The string is added to GSM-SMS messages, e-mails, web page headers etc.

20.10. SMS1-2-3-4 TELEPHONE NUMBERS

These telephone number buffers accept up to 16 digits.





Enter numbers starting from first character. Do not leave blank characters at the beginning.

20.11. ADJUST DATE AND TIME



These parameters allow adjustment of the battery backup real time clock of the module.

Once set, the clock will continue to run for years even if the power is removed from the unit.

The  button will switch to the next parameter and adjust with  and  buttons.



Parameters are saved with long-press on  button.

Parameter Definition	Unit	Min	Max	Description
Date	-	01	31	Current day of the month.
Month	-	01	12	Current month.
Year	-	00	99	Last two digits of the current year.
Hours	-	00	23	Current hour of the day.
Minutes	-	00	59	Current minute of the hour.

20.12. GSM MODEM PARAMETERS

Parameter Definition	Description
APN User Name	The APN (access point name) username may be required by the GSM operator. However some GSM operators may allow access without username. The exact information should be obtained from the GSM operator. Please search the GSM operator's website with "APN" string.
APN Password	If the APN (access point name) username is required by the GSM operator, most probably the APN password will also be required. However some GSM operators may allow access without password. The exact information should be obtained from the GSM operator. Please search the GSM operator's website with "APN" string.
APN Name	The APN (access point name) is always required by the GSM operator. The exact information should be obtained from the GSM operator. Please search the GSM operator's website with "APN" string.
SMS Service Center Number	The SMS service center number may be required by the GSM operator. However some GSM operators may allow SMS sending without SMS service center number. The exact information should be obtained from the GSM operator. Please search the GSM operator's website with "sms service center" string.



Below GSM modem related parameters are found in the Controller Configuration group.

Parameter Definition	Unit	Min	Max	Factory Set	Description
Modem Selection	-	0	1	0	0: not used 1: external GSM Datakom modem
SMS Enable	-	0	1	0	0: SMS messages disabled 1: SMS messages enabled
GPRS Connection Enable	-	0	1	0	0: GPRS disabled 1: GPRS enabled
SMS on Output Change	-	0	1	0	This parameter controls SMS sending when any output has changed state. No warnings generated. 0: no SMS on output change 1: SMS sent on output change
SMS on IP Change	-	0	1	0	0: no SMS on IP address change 1: SMS sent on IP addresschange
SMS Commands Enabled	-	0	1	0	0: SMS commands not accepted 1: SMS commands are accepted but from listed telephone numbers only.

20.13. ETHERNET PARAMETERS

Parameter Definition	Factory Set	Description
Network IP Address	0.0.0.0	This is the IPv4 (internet protocol version 4) address that the unit will require from the DHCP (dynamic host control protocol) server. If this parameter is set to 0.0.0.0 then the unit will require any IPv4 address from the DHCP server. If you are not an IP professional please leave this address as "0.0.0.0".
Gateway IP Address	0.0.0.0	This is the router IPv4 address, If the Network IP address and Gateway IP Address are set to "0.0.0.0" then the unit will get the gateway address automatically. If you are not an IP professional please leave this address as "0.0.0.0".
Subnet Mask	255.255.255.0	Reserved for IP professionals. If you are not an IP professional please leave this address as "255.255.255.0".
User IP Mask 1 (2) (3)	255.255.255.255 0.0.0.0 0.0.0.0	These 3 registers control the IPv4 access to the unit. The remote IPv4 address is logical AND'ed with these IP addresses. If the result gives the remote IP address, then access is enabled. Thus access may be limited to the same LAN members (x.x.x.255) or strictly to predefined IPv4 addresses.
Domain Name	d500.dyndns-ip.com	This string is used in " Dynamic DNS " feature. The unit will register itself to the dynamic DNS server under this name. For more detailed information please review chapter on " Dynamic DNS Feature " and the document " Dynamic DNS Account Setting ".
Membership Address	members.dyndns.org	This string is used in " Dynamic DNS " feature. This is the address used in registering to the dynamic DNS server. For more detailed information please review chapter on " Dynamic DNS Feature " and the document " Dynamic DNS Account Setting ".
Username/Password		These strings are used in " Dynamic DNS " feature while registering to the dynamic DNS server. For more detailed information please review chapter on " Dynamic DNS Feature " and the document " Dynamic DNS Account Setting ".
Ping Address	www.google.com	This internet address is regularly accessed in order to check the availability of internet access. The access period is defined in parameter Controller Configuration>Ping Period .
IP Confirmation Address	checkip.dyndns.org	This internet address is regularly accessed in order to read the IPv4 address of the unit.
Rainbow Address-1 Rainbow Address-2	-	These parameters accept both internet addresses (like http://datakom.com.tr) and IPv4 addresses (like 78.192.238.116). Information for remote monitoring is sent to these addresses. The port information of these addresses are found in Controller Configuration group.

20.13. ETHERNET PARAMETERS (continued)

Parameter Definition	Factory Set	Description
Mail Account Name	d500_a	This is the account name appearing in the “from” tab of the e-mail recipient. (ex: datakom-d500@gmail.com)
Mail Account Password	d500_1234	This is the e-mail password of above e-mail account.
Mail Server Address	smtp.mail.yahoo.com	This is the Outgoing Mail Server Address of the above e-mail account (ex: smtp.gmail.com)
E-mail Address-1 E-mail Address-2 E-mail Address-3	- - -	These are e-mail recipient addresses where the unit is intended to send e-mail messages. Up to 3 e-mails can be sent at once.



Below ETHERNET related parameters are found in the Controller Configuration group.

Parameter Definition	Unit	Min	Max	Factory Set	Description
Web Refresh Rate	sec	0	240	5	The unit will refresh the web page with this interval.
Ethernet Enable	-	0	1	1	0: ethernet port disabled 1: ethernet port enabled
E-mail on IP Change	-	0	1	0	0: no e-mail on IP change 1: e-mail sent on IP change
Ping Period	sec	30	900	120	The unit will check the availability of the internet connection with this interval.
Rainbow Scada Refresh Rate	sec	0	65535	60	The unit will update the distant monitoring terminal with this rate.
Rainbow Scada Address-1 Port	-	0	65535	90	This is the port number of the first monitoring terminal address.
Rainbow Scada Address-2 Port	-	0	65535	90	This is the port number of the second monitoring terminal address.
Web Server Port	-	0	65535	80	This is the port number of the internal web server. The unit will answer queries to this port only.
Modbus TCP/IP Port	-	0	65535	502	Internal Modbus TCP/IP server's port number. The unit answers Modbus requests to this port only.
SMTP Port	-	0	65535	587	Port number used for e-mail sending.

21. ETHERNET CONFIGURATION

Please see related document: **Ethernet Configuration Guide for D-500 D-700.**

22. GSM CONFIGURATION

Please see related document: **GSM Configuration Guide for D-500 D-700.**

23. DYNAMIC DNS FEATURE

Please see related document: **Dynamic DNS Account Setting for D-500 D-700.**

24. ACCESSING THE EMBEDDED WEB SERVER

The embedded web server is accessible through the IP address of the controller, using the ETHERNET connection. The IP address is displayed at the top of ETHERNET screen.

Please note that the controller supports **DYNAMIC DNS UPDATE** feature, in order to associate the dynamic IP address to a domain name that does not change in time.

The web server offers 4 tabs:

- Measurements:** Measured electrical values
- Counters:** Power counters and incremental counters
- Event logs:** Last 15 event logs with date-time and full snapshot
- Alarm list:** List of existing fault conditions.

The screenshot shows a web browser window with the address bar displaying '192.168.2.43'. The page title is 'WEB Scada'. Below the title, there are four tabs: 'Measurements', 'Counters', 'Events', and 'Alarms'. The 'Measurements' tab is active and displays a table of electrical data.

LINE		POWER		THDs	
L1 Volt	230.2 V	Tot P	200.7 kW	THD L1	0.4 %
L2 Volt	230.1 V	Tot Q	51.1 kVAr	THD L2	1.6 %
L3 Volt	230.1 V	Tot S	207.1 kVA	THD L3	1.6 %
L12 Volt	399.0 V	PowFactor	0.969 ind	THD L12	1.9 %
L23 Volt	398.6 V	Demand I1	300.9 A	THD L23	8.3 %
L31 Volt	398.5 V	Demand I2	300.6 A	THD L31	2.1 %
L1 Amps	300.5 A	Demand I3	300.4 A	THD I1	0.4 %
L2 Amps	300.1 A	Demand Io	300.5 A	THD I2	1.5 %
L3 Amps	300.3 A	Demand P	207.4 W	THD I3	1.6 %
N Amps	0.0 A	Demand Q	51.3 kVAr	THD In	0.0 %
Frequency	50.00 Hz				
V-avrg	230.1 V				
U-avrg	398.7 V				
I-avrg	300.3 A				

Homepage: Measurements Display

WEB Scada

Measurements Counters Events Alarms

COUNTERS

Import Power (kWh1-Im)	1368.2 kWh
Export Power (kWh1-Ex)	504.3 kWh
Inductive Power (kVARh1-In)	13.8 kVARh
Capacitive Power (kVARh1-Cp)	42.4 kVARh
Import Power (kWh2-Im)	0.0 kWh
Export Power (kWh2-Ex)	0.0 kWh
Inductive Power (kVARh2-In)	0.0 kVARh
Capacitive Power (kVARh2-Cp)	0.0 kVARh
Input Counter 1 (InCnt-1)	0
Input Counter 2 (InCnt-2)	0

Counters Page

WEB Scada

Measurements Counters Events Alarms

ALARM TYPE ALARM

No Alarm

End of Alarm List

Alarm List Page

WEB Scada

Measurements Counters Events Alarms

#	Event	Alarm	Date	Time	State	Status	L1 Voltage	L2 Voltage	L3 Voltage	Frequency	L12 Voltage	L23 Voltage	L31 Voltage	L1 Current	L2 Current	L3 Current
0	Periodic	0	28-03-2082	01:13:21			176 V	176 V	175 V	50.0 Hz	305 V	305 V	305 V	150 V	150 V	149 V
1	Periodic	0	28-03-2082	00:13:14			176 V	176 V	176 V	50.0 Hz	305 V	305 V	305 V	300 V	300 V	149 V
2	Periodic	0	27-03-2082	23:13:08			175 V	176 V	176 V	50.0 Hz	305 V	305 V	305 V	300 V	299 V	150 V
3	Periodic	0	27-03-2082	22:19:02			176 V	176 V	176 V	50.0 Hz	305 V	305 V	305 V	300 V	300 V	150 V
4	Periodic	0	27-03-2082	19:36:20			0 V	0 V	0 V	0 Hz	0 V	0 V	0 V	0 V	0 V	0 V
5	Periodic	0	27-03-2082	18:36:20			0 V	0 V	0 V	0 Hz	0 V	0 V	0 V	0 V	0 V	0 V
6	Periodic	0	27-03-2082	17:36:20			0 V	0 V	0 V	0 Hz	0 V	0 V	0 V	0 V	0 V	0 V
7	Periodic	0	27-03-2082	16:36:19			0 V	0 V	0 V	0 Hz	0 V	0 V	0 V	0 V	0 V	0 V
8	Periodic	0	27-03-2082	15:36:19			0 V	0 V	0 V	0 Hz	0 V	0 V	0 V	0 V	0 V	0 V
9	Periodic	0	27-03-2082	14:36:18			0 V	0 V	0 V	0 Hz	0 V	0 V	0 V	0 V	0 V	0 V
10	Periodic	0	27-03-2082	13:36:18			0 V	0 V	0 V	0 Hz	0 V	0 V	0 V	0 V	0 V	0 V
11	Periodic	0	27-03-2082	12:36:17			0 V	0 V	0 V	0 Hz	0 V	0 V	0 V	0 V	0 V	0 V
12	Periodic	0	27-03-2082	11:36:17			0 V	0 V	0 V	0 Hz	0 V	0 V	0 V	0 V	0 V	0 V
13	Periodic	0	27-03-2082	10:36:17			0 V	0 V	0 V	0 Hz	0 V	0 V	0 V	0 V	0 V	0 V
14	Periodic	0	27-03-2082	09:36:16			0 V	0 V	0 V	0 Hz	0 V	0 V	0 V	0 V	0 V	0 V
15	Periodic	0	27-03-2082	08:36:16			0 V	0 V	0 V	0 Hz	0 V	0 V	0 V	0 V	0 V	0 V

Event Log Display Page

Please see related document: **Ethernet Configuration Guide for D-500 D-700** for more details.

25. WEB MONITORING

Please see related document: **Ethernet Configuration Guide for D-500 D-700.**

26. CENTRAL MONITORING

Please see related document: **Rainbow Scada Usage Guide.**

27. E-MAIL SENDING

Please see related document: **Ethernet Configuration Guide for D-500 D-700.**

28. ETHERNET/GPRS – MODBUS GATEWAY OPERATION

This feature is not available yet.

29. SMS COMMANDS



SMS messages are accepted only from phone numbers recorded in the **Communication>GSM>Message Numbers** tab.

Answers to SMS messages will be sent to all phone numbers in the list.



SMS messages must be written exactly as below, without any preceding blanks.

Only **UPPERCASE** characters are permitted.

COMMAND	DESCRIPTION	ANSWER
GET IP	If GPRS connection is active, the controller will reply by an SMS message indicating the IP address of the GSM modem.	<i>IP: 188.41.10.244</i>
GPRS 1	Activates the GPRS connection	GPRS enabled!
GPRS 0	Stops the GPRS connection	GPRS disabled!
RESET ALARMS	Clears alarms of the controller. The operating mode is not modified.	Alarms cleared!
REBOOT	Performs a hard reset on the controller	no answer

30. DATA RECORDING

30.1. DATA RECORDING MEDIA

Data can be recorded in USB flash memory.

As soon as a USB flash memory is inserted, the unit will start data recording and continue until the memory is removed.



USB FLASH MEMORY

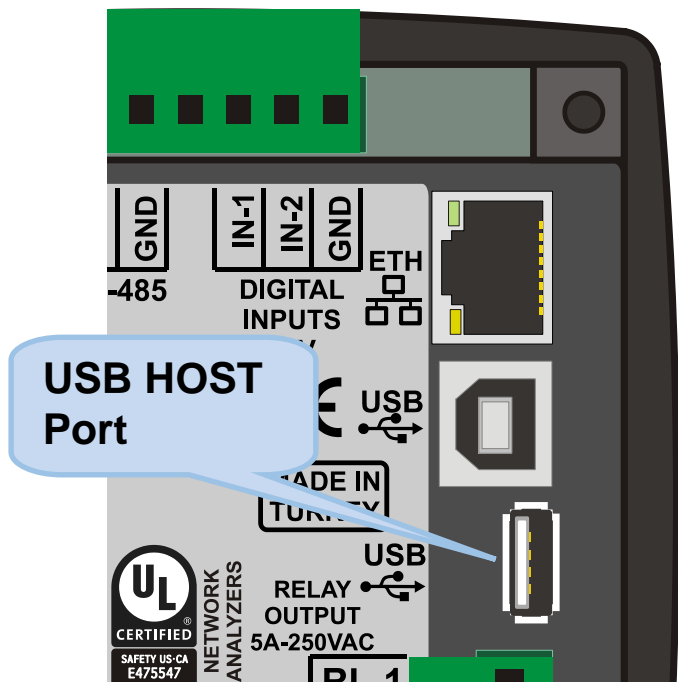

If USB-Device is plugged then USB-Host port will not function.

30.2. DIRECTORY STRUCTURE

The unit will record data in a USB-Flash memory. The record structure is below:

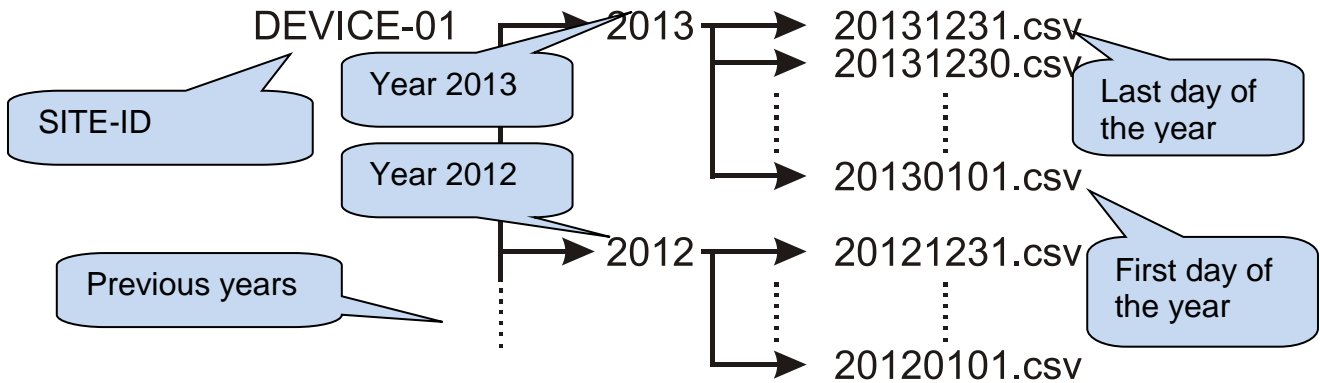

The unit will record data in a directory named with the first 11 characters of its site-id parameter. In order to avoid confusion between records, it is highly recommended to configure the site-id parameter accordingly to the place where the device is installed. Thus the same memory module may be used for recording in different devices.

Inside the <SITE-ID> directory, the unit will open a separate directory for each year of recording. The directory will be simply named by the year, like 2012, 2013 etc...

Inside the year directory, the unit will record data in a different file for each day of recording. The record file will be named YYYYMMDD like "20120331" representing March '31, 2012. Thus alphabetical listing will produce a sorted list by date of recording.

The recorded file is of CSV (comma separated values) type. This is a text file which can be directly opened with Microsoft Excel program without any loss of information. It can be also opened with any text editor (like Notepad program).

Inside the file, each record consists of a line including a large set of measured parameters. The recorded parameters list is not adjustable. The controller records all practically necessary parameters.

30.3. UNDERSTANDING THE CSV FORMAT

The ".csv" file is basically a text file format. Thanks to this, it can be opened by any text editor in any operating system.

When opened with the Microsoft Excel program, the values will appear in tabulated form, enabling application of formulas, graphs and other features of Excel program.

30.4. RECORDED DATA LIST, RECORD PERIOD

The recording period is adjustable between 10 seconds and 18 hours by program parameter.

A short period will give better resolution, but it will store more data in the memory card, therefore a larger capacity will be required.

One data record is typically 500 bytes long, thus with a minimum period of 10 seconds, the unit will store 4.3 MB of data per day (050x6x60x24). A typical memory of 4GB will store data during 948 days, more than 2 years.

With a recording period of 1 minute, 4GB memory card will store data during 15 years.

Below parameters are recorded:

- Date and time
- Ph-N voltages: V1-V2-V3
- Ph-Ph voltages: U12-U23-U31
- Phase currents: I1-I2-I3
- Frequency
- Average Ph-N voltage: Va
- Average Ph-Ph voltage: Ua
- Average current: Ia
- Total active power (kW)
- Total reactive power (kVAr)
- Total apparent power (kVA)
- Total power factor (pf)
- Demands: dI1-dI2-dI3-dIn-dkW-dkVAr
- Total harmonic distortion: V1-V2-V3-U12-U23-U31-I1-I2-I3-In

31. MODBUS COMMUNICATIONS



This chapter is a brief description of the Modbus properties of the device. For a complete documentation please use: “DKM-411 Modbus Application Manual”

The unit offers the possibility of MODBUS communication through below carriers:

- RS485 serial port, with adjustable baud rate between 2400 and 115200 bauds
- MODBUS-TCP/IP through Ethernet port (10/100Mb)
- MODBUS-TCP/IP through GPRS (85/42kb), client mode through Rainbow Scada only

The MODBUS properties of the unit are:

- Data transfer mode: RTU
- Serial data: selectable baud rate, 8 bit data, no parity, 1 bit stop
- Modbus-TCP/IP: Ethernet 10/100Mb or GPRS Class 10.
- Supported functions:
 - Function 3 (Read multiple registers)
 - Function 6 (Write single register)
 - Function 16 (Write multiple registers)

Each register consists of 2 bytes (16 bits). A larger data structure will contain multiple registers.

The Modbus communications requires a slave address to be assigned to each device in the Modbus network. This address ranges between 1 and 240 and allows the addressing of different slave devices in the same network.



Each device in the same RS-485 serial network must be assigned a different slave address. Otherwise the Modbus communications will not be performed.



Devices using Modbus-TCP/IP with different IP or port addresses may use any slave address. It is advised to set these slave addresses to the default setting which is 1.

31.1. PARAMETERS REQUIRED FOR RS-485 MODBUS OPERATION

Modbus Slave Address: may be set between 1 and 240

RS-485 Enable: must be set to 1 (or checkbox enabled)

RS-485 Baud Rate: selectable between 2400 and 115200 bauds. All devices in the same network must use the same Baud Rate.

The complete RS-485 port specifications are found in the [D-500/700 User Manual](#).

Selecting a higher baud rate will allow faster communication, but will reduce the communication distance. Selecting a lower baud rate will increase the communication distance, but will cause slower response times.

Typically 9600 bauds will allow 1200m distance with special balanced 120 ohms cable.

31.2. PARAMETERS REQUIRED FOR MODBUS-TCP/IP VIA ETHERNET

Modbus Slave Address: may be set between 1 and 240. If only one unit is available in the same IP address, it is advised to keep the default address (1).

Ethernet Enable: This parameter should be set to 1 (or checked) in order to enable the ethernet port.

Modbus TCP/IP Port: The usual setting is 502. However the unit is able to work on any port address.

User IP Mask: There are 3 mask registers available. The use of the registers are emphasized in the D-500/700 User Manual. Please set the first mask as 255.255.255.0 for the proper operation.

Ethernet Network IP: May be left as 0.0.0.0 for automatic address claim or set to a value in order to claim a defined address.

Ethernet Gateway IP: Should be set in accordance with your local switch configuration.

Ethernet Subnet Mask: Should be set in accordance with your local switch configuration.

Please review the document [Ethernet Configuration Guide for DKM-411](#) for more details about the ethernet port setup.

31.3. DATA FORMATS

16bit variables: These variables are stored in a single register. Bit_0 denotes the LSB and bit 15 denotes the MSB.

32 bit variables: These variables are stored in 2 consecutive registers. The high order 16 bits are in the first register and the low order 16 bits are in the second register

Bit arrays: Arrays larger than 16 bits are stored in multiple registers. The LSB of the first register is bit_0. The MSB of the first register is bit_15. The LSB of the second register is bit_16. The MSB of the second register is bit_31, and so on.

Below is a shortlist of available Modbus registers. For complete register map please refer to DKM-411 Modbus Application Manual.

ADDRESS (decimal)	R / W	DATA SIZE	COEFF.	DESCRIPTION
20480	R	32bit	x10	Phase L1 voltage
20482	R	32bit	x10	Phase L2 voltage
20484	R	32bit	x10	Phase L3voltage
20486	R	32bit	x10	Phase L1-L2 voltage
20488	R	32bit	x10	Phase L2-L3 voltage
20490	R	32bit	x10	Phase L3-L1voltage
20492	R	32bit	x10	Phase L1 current
20494	R	32bit	x10	Phase L2 current
20496	R	32bit	x10	Phase L3 current
20498	R	32bit	x10	Neutral current
20500	R	32bit	x10	Phase L1 active power
20502	R	32bit	x10	Phase L2active power
20504	R	32bit	x10	Phase L3active power
20506	R	32bit	x10	Total active power
20508	R	32bit	x10	Phase L1 reactive power
20510	R	32bit	x10	Phase L2reactive power
20512	R	32bit	x10	Phase L3reactive power
20514	R	32bit	x10	Total reactive power
20516	R	32bit	x10	Phase L1 apparent power
20518	R	32bit	x10	Phase L2apparent power
20520	R	32bit	x10	Phase L3apparent power
20522	R	32bit	x10	Total apparent power
20524	R	16bit	x10	Phase L1 power factor
20525	R	16bit	x10	Phase L2power factor
20526	R	16bit	x10	Phase L3power factor
20527	R	16bit	x10	Total power factor
20528	R	16bit	x100	Frequency
20529	-	-	-	-
20530	-	-	-	-
20531	-	-	-	-
20532	R	32bit	X10	Average Ph-N voltage
20534	R	32bit	X10	Average Ph-Ph voltage
20536	R	32bit	X10	Average current
20538	R	16bit	x10	Phase L1 tangent(teta) P1/Q1
20539	R	16bit	x10	Phase L2 tangent(teta) P2/Q2
20540	R	16bit	x10	Phase L3 tangent(teta) P3/Q3
20541	R	16bit	x10	Total tangent(teta) P/Q
20542	R	16bit	x10	Voltage Unbalance %
20543	R	16bit	x10	Current Unbalance %

32. SNMP COMMUNICATIONS

The unit offers the possibility of SNMP communication through its Ethernet port (10/100Mb)



The supported version of the SNMP is V1.0.

Below parameters may be set to the controller:

Control Buttons

Below parameters may be read from the controller:

Voltages (L1, L2, L3, L12, L23, L31)

Currents (I1, I2, I3, IN)

Active Power (L1, L2, L3, Total)

Reactive Power (L1, L2, L3, Total)

Apparent Power (L1, L2, L3, Total)

Power Factor (L1, L2, L3, Total)

Frequency

Total kW-h counter-1

Total kVAR-h inductive counter-1

Total kVAR-h capacitive counter-1

Incremental Counter-1

Total kW-h counter-2

Total kVAR-h inductive counter-2

Total kVAR-h capacitive counter-2

Incremental Counter-2

Alarm List

Warning List



The SNMP MIB file is available at Datakom Technical support.

32.1. PARAMETERS REQUIRED FOR SNMP VIA ETHERNET

Modbus Slave Address: may be set between 1 and 240. If only one unit is available in the same IP address, it is advised to keep the default address (1).

Ethernet Enable: This parameter should be set to 1 (or checked) in order to enable the ethernet port.

Modbus TCP/IP Port: The usual setting is 502. However the unit is able to work on any port address.

User IP Mask: There are 3 mask registers available. The use of the registers are emphasized in the DKM-411 User Manual. Please set the first mask as 255.255.255.0 for the proper operation.

Ethernet Network IP: May be left as 0.0.0.0 for automatic address claim or set to a value in order to claim a defined address.

Ethernet Gateway IP: Should be set in accordance with your local switch configuration.

Ethernet Subnet Mask: Should be set in accordance with your local switch configuration.

The complete Ethernet port specifications are found in the **DKM-411 User Manual**.

Please review the document **Ethernet Configuration Guide for DKM-411** for more details about the ethernet port setup.

33. CALIBRATION



Calibration can be modified only with a special password.

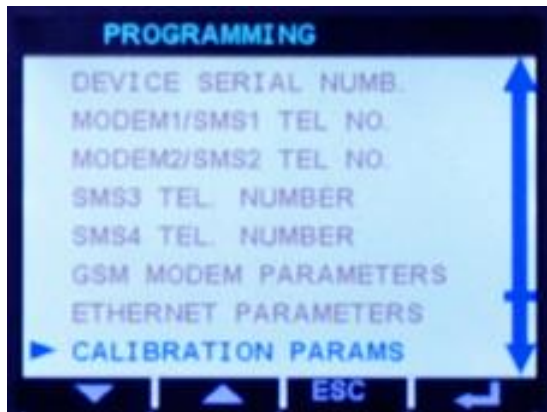

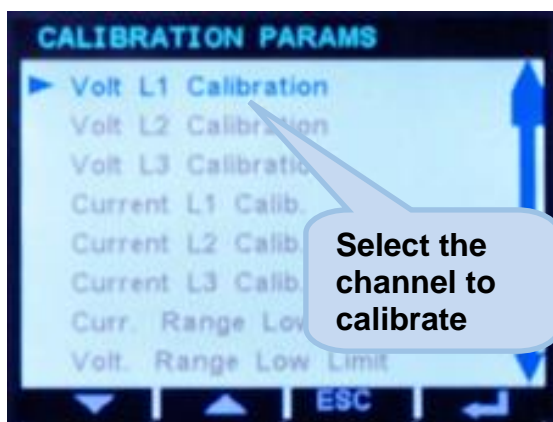

The unit is factory calibrated but it is possible to recalibrate it in order to obtain equal display values on different measuring instruments.

The calibration is done through the PROGRAMMING menu. A special password is required for calibration.

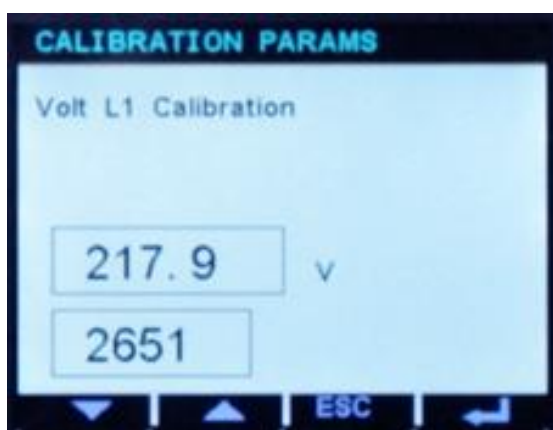

Select “**CALIBRATION PARAMS**” on “**CONFIGURATION MENU**”. Then select the channel to calibrate with  and , and then press .



Then adjust the coefficient until required measured value is displayed on the bottom right of the screen then long-press  to save the new calibration coefficient and return to “**CONFIGURATION MENU**”.

34. DECLARATION OF CONFORMITY

The unit conforms to the EU directives

-2006/95/EC (low voltage)

-2004/108/EC (electro-magnetic compatibility)

Norms of reference:

EN 61010 (safety requirements)

EN 61326 (EMC requirements)

The CE mark indicates that this product complies with the European requirements for safety, health, environmental and customer protection.

UL / CSA Conformity:

certification testing in progress

UL 508, Edition 17

UL 2200, 1st Edition.

UL 840 Edition 3

CSA C22.2 NO. 14 - Edition 10

35. MAINTENANCE



DO NOT OPEN THE UNIT !

There are NO serviceable parts inside the unit.

Repair can be performed by the manufacturer only. Calibration may be verified or done during operation.

Wipe the unit, if necessary with a soft damp cloth. Do not use chemical agents.

The device is subject to detailed safety and quality checks before shipment.

When a device is opened, checks must be done again in full.



Opening a device will cancel the warranty.

Internal battery

The internal real time clock (RTC) is supplied with power from the auxiliary supply voltage. If the device is not powered on, the RTC is supplied by the internal lithium battery (CR2032 type). The lifetime of the battery is minimum 5 years, the expected life is 8 to 10 years.



Internal battery is replaced by the manufacturer only.

36. DISPOSAL OF THE UNIT

Following **DIRECTIVE 2002/96/EC OF THE EUROPEAN PARLIAMENT AND OF THE COUNCIL of 27 January 2003 on waste electrical and electronic equipment (WEEE)**, this unit should be stored and disposed separately from the usual waste.

The internal lithium battery must be disposed off separately.

37. ROHS COMPLIANCE

The european ROHS directive restricts and prohibits the use of some chemical materials in electronic devices.

Following the “**DIRECTIVE 2011/65/EU OF THE EUROPEAN PARLIAMENT AND OF THE COUNCIL of 8 June 2011 on the restriction of the use of certain hazardous substances in electrical and electronic equipment**”, this product is listed in annex-I under category: “**Monitoring and control instruments including industrial monitoring and control instruments**” and exempted from ROHS directive.

However Datakom is not using any ROHS uncompliant electronic components in the production. Only the solder contains lead. The switching to unleaded solderin is in progress.

38. TROUBLESHOOTING GUIDE



Below is a basic list of most often encountered troubles. More detailed investigation may be required in some cases.

No display:

- External fusing for the power supply voltage has tripped. Switch fuse on or replace fuse.
- Incorrect auxiliary supply voltage, check voltage at power supply terminals.
- Incorrect power supply polarity for DC supply versions.
- Device is defective. Send device to the manufacturer for repair.

Incorrect voltage display:

- Measured voltages are not connected. Connect measuring-circuit voltages.
- **Important!** Ensure the measurement inputs are not overloaded.
- The voltage measuring range has been exceeded. Check device ratings.
- The voltage measuring range has been exceeded by harmonic components. Check harmonics.
- Connect voltage transformer if necessary.
- Incorrect phase connections. Check wiring.
- Voltage transformer ratio incorrectly programmed. Check program parameter and voltage transformer.
- Device is defective. Send device to the manufacturer for repair.

Incorrect current display:

- Measured currents are not connected. Connect measuring-circuit current inputs.
- **Important!** Ensure the measurement inputs are not overloaded.
- The current measuring range has been exceeded. Check device ratings.
- The current measuring range has been exceeded by harmonic components. Check harmonics.
- Incorrect phase connections. Check wiring.
- Current transformer ratio incorrectly programmed. Check program parameter and current transformer ratings.
- Device is defective. Send device to the manufacturer for repair.

Incorrect active/reactive power and power factor display:

- Check voltage and current displays. If incorrect, follow above instructions.
- Current transformers are not connected to correct inputs or some CTs are connected with reverse polarity. Determine the correct connections of each individual CT in order to obtain correct KW and power factor display for the related phase.
- Please review chapter: “**AC CURRENT INPUTS**”
-
- Measured currents are not connected. Connect measuring-circuit current inputs.
- **Important!** Ensure the measurement inputs are not overloaded.
- The current measuring range has been exceeded. Check device ratings.
- The current measuring range has been exceeded by harmonic components. Check harmonics.
- Incorrect phase connections. Check wiring.
- Current transformer ratio incorrectly programmed. Check program parameter and current transformer ratings.
- Device is defective. Send device to the manufacturer for repair.

RS-485 connection does not work:

- Check polarity of A-B terminals.
- Incorrect device address.
- Missing termination resistors. Terminate bus with 120 ohm resistors from both ends.
- Incorrect baud rate selection. Select correct baud rate.
- RS-485 port not enabled. Check program parameter.
- Device is defective. Send device to the manufacturer for repair.

Programming mode can not be entered:

Enter correct password. Try with “3282” as password.

Some program parameters are skipped:

- These parameters require a higher level of password.