

DFC-0124

REACTIVE POWER CONTROLLER

DESCRIPTION

DFC-0124 is an advanced precision 24 step power factor control and metering device. It continuously matches the target $\text{Cos}\phi$ of the load. Thanks to its SVC outputs, the device performs exact compensation. The device is also a network analyzer; it measures, displays and logs various AC parameters in a 3-phase network.

The Windows based PC software allows monitoring and programming through USB, RS-485, Ethernet and GPRS.

Firmware upgrade process through USB port allows users to take advantage of latest software developments of the device free of charge.

The PC based Rainbow Scada software allows monitoring and control of an unlimited number of devices from a single location.

SVC OUTPUTS

SVC stands for "Static Var Compensation".

The unit has 3 SVC outputs which are duty cycle controlled PWMs that control 3 reactors with a precision of 1000 steps.

Thus the controller is able to supply almost any required reactive power, enabling matching the exact required PF, independently from capacitor bank selection.

FEATURES

- *Internal GPRS Modem*
- *Internal Ethernet port, 10/100Mb*
- *RS-485 isolated (Modbus RTU)*
- *RS-232 (for external GPRS modem)*
- *USB Host (for data recording on flash memory)*
- *USB Device (for PC connection)*
- *Modbus RTU RS-485, 2400-115200 baud*
- *Modbus TCP/IP*
- *UDP*
- *SNTP*
- *SNMP*
- *TCP/IP server & client*
- *SMTP*
- *Dynamic DNS support*
- *Embedded website, HTML*
- *GSM-SMS sending*
- *E-mail sending*
- *Central Monitoring through IP*

FUNCTIONS

- *Automatic setup under load*
- *Automatic correction of connection faults*
- *24-18-12 step output options*
- *All steps can drive contactors/thyristors*
- *Always exact correction with SVC outputs*
- *Compensation on low current (3 mA)*
- *Reactive power correction in 20 ms*
- *Separate target $\text{Cos}\phi$ for generator*
- *User configurable screens and relay outputs*



COPYRIGHT NOTICE

Any unauthorized use or copying of the contents or any part of this document is prohibited.

ABOUT THIS DOCUMENT

This document describes minimum requirements and necessary steps for the successful installation of the DFC0124 family units.

Follow carefully advices given in the document. These are often good practices for the installation, which may reduce future issues. For all technical queries please contact Datakom at below e-mail address:

technical.support@datakom.com.tr

QUERRIES

If additional information to this manual is required, please contact the manufacturer directly at below email address:

technical.support @datakom.com.tr

Please provide following information in order to get answers to any question:

- Device model name (see the back panel of the unit),
- Complete serial number (see the back panel of the unit),
- Firmware version (read from the display screen),
- Measuring-circuit voltage and power supply voltage,
- Precise description of the query.

RELATED DOCUMENTS

FILENAME	DESCRIPTION
0124_INST	DFC-0124 Installation Guide
Rainbow Plus Installation	Rainbow Plus Installation Guide
Rainbow Plus User	Rainbow Plus User Guide

REVISION HISTORY

REVISION	DATE	AUTHOR	DESCRIPTION
01	23.03.2017	TO	First edition

TERMINOLOGY



CAUTION: Potential risk of injury or death.



WARNING: Potential risk of malfunction or material damage.



ATTENTION: Useful hints for the understanding of device operation.

ORDERING CODES

The DFC0124 family units are available in various options and peripheral features. Please use below information for ordering the correct version:

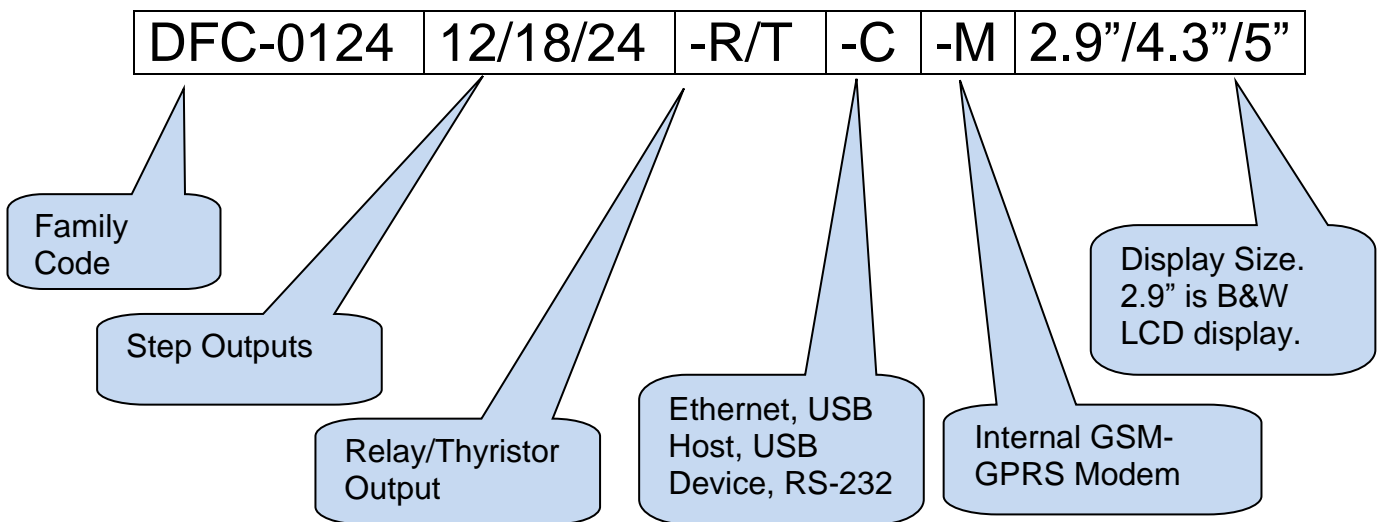

SPARE PARTS



Screw type bracket
Stock Code=J10P01 (per unit)



Self Retaining type bracket
Stock Code=K16P01 (per unit)



SAFETY NOTICE

**Failure to follow below instructions
will result in death or serious injury**



- Electrical equipment should be installed only by qualified specialist. No responsibility is assured by the manufacturer or any of its subsidiaries for any consequences resulting from the non-compliance to these instructions.



- Check the unit for cracks and damages due to transportation. Do not install damaged equipment.



- Do not open the unit. There are no serviceable parts inside.
- Fuses must be connected to the power supply and phase voltage inputs, in close proximity of the unit.
- Fuses must be of fast type with a maximum rating of 6A.



- Disconnect all power before working on equipment.



- When the unit is connected to the network do not touch terminals.



- Short circuit terminals of unused current transformers.



- Any electrical parameter applied to the device must be in the range specified in the user manual. Although the unit is designed with a wide safety margin, over-range parameters may reduce lifetime, alter operational precision or even damage the unit.
- Do not try to clean the device with solvent or the like. Only clean with a damp cloth.
- Verify correct terminal connections before applying power.
- Only for panel base mounting.

TABLE OF CONTENTS

1. INSTALLATION INSTRUCTIONS
2. MOUNTING
 - 2.1 DIMENSIONS
 - 2.2 SEALING, GASKET
 - 2.3 ELECTRICAL INSTALLATION
3. AUTO SETUP
4. TERMINAL DESCRIPTIONS
 - 4.1. SUPPLY VOLTAGE INPUT
 - 4.2. AC VOLTAGE INPUTS
 - 4.3. AC CURRENT INPUTS
 - 4.4. RELAY OUTPUTS
 - 4.5. SVC OUTPUTS
 - 4.6. THYRISTOR OUTPUTS
 - 4.7. RS-485 PORT
 - 4.8. USB DEVICE PORT
 - 4.9. USB HOST PORT
 - 4.10. ETHERNET PORT
 - 4.11. GSM MODEM
5. CONNECTION DIAGRAM
6. TECHNICAL SPECIFICATIONS
7. TERMINAL DESCRIPTIONS
8. DESCRIPTION OF CONTROLS
 - 8.1. FRONT PANEL FUNCTIONALITY
 - 8.2. PUSHBUTTON FUNCTIONS
9. MEASURED PARAMETERS
10. INDICATOR SYMBOLS
11. WAVEFORM DISPLAY & HARMONIC ANALYSIS
12. EVENT LOGS
13. COUNTERS
14. DEMAND MEASUREMENT
15. MIN-MAX MEASUREMENT
16. PROTECTION AND ALARMS
17. PROGRAMMING
 - 17.1. ENTERING THE PROGRAMMING MODE
 - 17.2. NAVIGATING BETWEEN MENUS
 - 17.3. MODIFYING PARAMETER VALUE
 - 17.4. PROGRAMMING MODE EXIT

18. PROGRAM PARAMETER LIST

18.1. CONTROLLER CONFIGURATION GROUP

18.2. ELECTRICAL PARAMETERS GROUP

18.2.1. PFC PARAMETERS GROUP

18.2.2. USER OUTPUT CONFIGURATION

18.2.3. RELAY PARAMETERS

18.2.4. THYRISTOR PARAMETERS

18.2.5. SVC PARAMETERS

18.3. COMMUNICATION PARAMETERS

18.3.1. NETWORK SETUP

18.3.2. GSM MODEM PARAMETERS

18.3.3. ETHERNET PARAMETERS

18.3.4. SMS PARAMETERS

18.3.5. RAINBOW PARAMETERS

18.3.6. E-MAIL PARAMETERS

18.3.7. SNTP PARAMETERS

18.4. MIN/MAX COUNTER SET

18.5. ALARM CONFIGURATION

18.5.1. ALARM PARAMETER GROUP

18.5.2. RECORD PARAMETERS

18.5.3. ALARM RELAY PARAMETERS

19. DATA RECORDING

19.1. USB FLASH MEMORY DATA RECORDING

19.2. DIRECTORY STRUCTURE

19.3. UNDERSTANDING THE CSV FORMAT

19.4. RECORDED DATA LIST, RECORD PERIOD

20. SNMP COMMUNICATION

20.1 PARAMETERS REQUIRED FOR SNMP VIA INTERNET

21. DECLARATION OF CONFORMITY

22. MAINTENANCE

23. DISPOSAL OF THE UNIT

24. ROHS COMPLIANCE

1. INSTALLATION INSTRUCTIONS

Before installation:

- Read the user manual carefully, determine the correct connection diagram.
- Remove all connectors and mounting brackets from the unit, then pass the unit through the mounting opening.
- Put mounting brackets and tighten. Do not tighten too much, this can damage the enclosure.
- Make electrical connections with plugs removed from sockets, then place plugs to their sockets.
- Be sure that adequate cooling is provided.
- Be sure that the temperature of the environment will not exceed the maximum operating temperature in any case.
- Be sure that the unit is not subject to water spill.

Below conditions may damage the device:

- Incorrect connections.
- Incorrect power supply voltage.
- Voltage at measuring terminals beyond specified range.
- Voltage applied to digital inputs over specified range.
- Current at measuring terminals beyond specified range.
- Overload or short circuit at relay outputs
- Connecting or removing data terminals when the unit is powered-up.
- High voltage applied to communication ports.
- Ground potential differences at non-isolated communication ports.
- Excessive vibration, direct installation on vibrating parts.



**Current Transformers must be used for current measurement.
No direct connection allowed.**

Below conditions may cause abnormal operation:

- Power supply voltage below minimum acceptable level.
- Power supply frequency out of specified limits
- Phase order of voltage inputs not correct.
- Current transformers not matching related phases.
- Current transformer polarity incorrect.

2. MOUNTING

2.1. DIMENSIONS

Dimensions: 164x164x69 mm
Panel Cutout: 140x140 mm minimum
Weight: 750g (approx.)





**The unit is designed for panel mounting.
The user should not be able to access parts of the
unit other than the front panel.**

Mount the unit on a flat, vertical surface. Before mounting, remove the mounting brackets and connectors from the unit, then pass the unit through the mounting opening. Place and tighten mounting brackets.

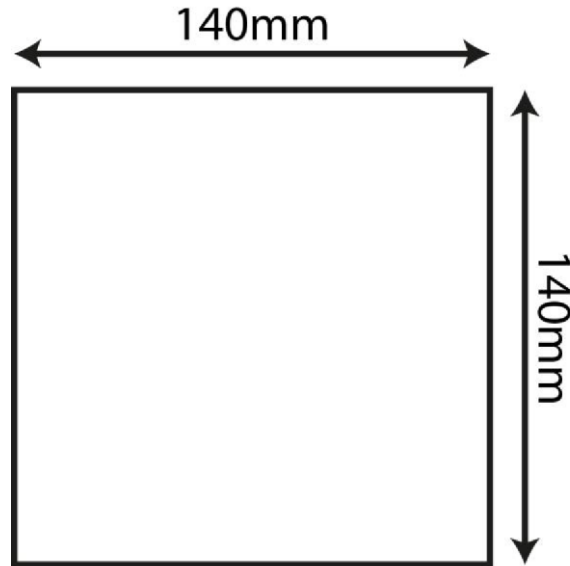

Panel Cutout

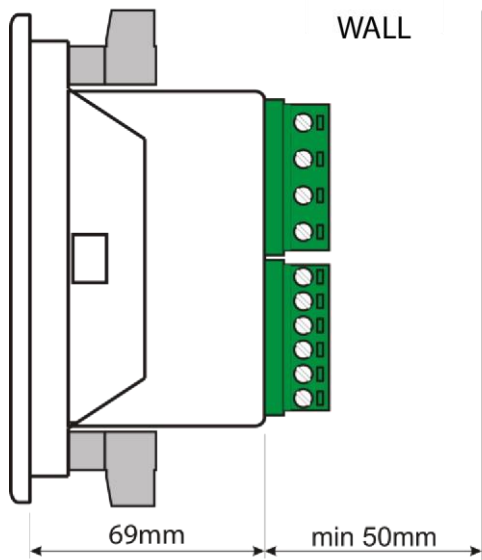

Required Panel Depth

Two different types of brackets are provided:



Screw type bracket



Self-retaining type bracket



Installation of screw type bracket



Installation of self-retaining type bracket

 **Do not tighten too much, this may break the unit.**

2.2. SEALING, GASKET

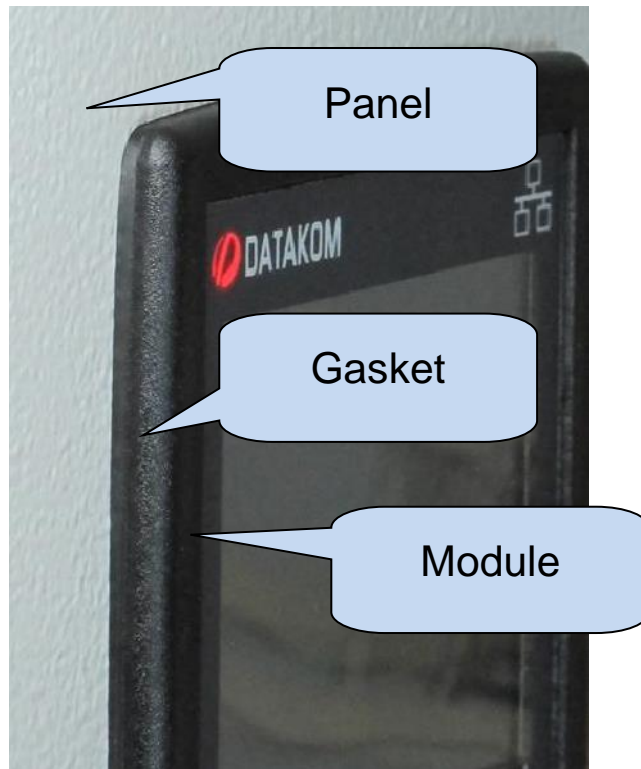

The rubber gasket provides a watertight means of mounting the module to the panel. Together with the gasket, IEC 60529-IP65 protection can be reached from the front panel. A short definition of IP protection levels are given below.

1st Digit

0 Not protected

1 Protected against solid foreign objects of 50 mm diameter and greater

2 Protected against solid foreign objects of 12,5 mm diameter and greater

3 Protected against solid foreign objects of 2,5 mm diameter and greater

4 Protected against solid foreign objects of 1,0 mm diameter and greater

5 Protected from the amount of dust that would interfere with normal operation

6 Dust tight

2nd Digit

0 Not protected

1 Protected against vertically falling water drops

2 Protected against vertically falling water drops when enclosure is tilted up to 15 °

3 Protected against water sprayed at an angle up to 60 ° on either side of the vertical

4 Protected against water splashed against the component from any direction

5 Protected against water projected in jets from any direction

6 Protected against water projected in powerful jets from any direction

7 Protected against temporary immersion in water

8 Protected against continuous immersion in water, or as specified by the user

2.3. ELECTRICAL INSTALLATION



Do not install the unit close to high electromagnetic noise emitting devices like contactors, high current busbars, switch mode power supplies and the like.

Although the unit is protected against electromagnetic disturbance, excessive disturbance can affect the operation, measurement precision and data communication quality.

- **ALWAYS** remove plug connectors when inserting wires with a screwdriver.
- Fuses must be connected to the power supply and phase voltage inputs, in close proximity of the unit.
- Fuses must be of fast type with a maximum rating of 6A.
- Use cables of appropriate temperature range.
- Use adequate cable section, at least 0.75mm² (AWG18).
- Follow national rules for electrical installation.
- Current transformers must have 5A output.
- For current transformer inputs, use at least 1.5mm² section (AWG15) cable.
- The current transformer cable length should not exceed 1.5 meters. If longer cable is used, increase the cable section proportionally.



Current Transformers must be used for current measurement.

No direct connection allowed.



Do not overload relay outputs. Use additional contactors if required.

3. AUTO SETUP

During Auto Setup:

- The device detects phase orders and performs auto correction.
- The device detects current transformers polarity and performs auto correction.
- The device detects current transformers order and performs auto correction.
- The device measures and records step output types and ratings.



In order to Perform Successful AUTO SETUP:

- Voltage inputs must be connected to a three-phase network, otherwise the device will display voltage alarm.
- First few outputs must be connected to the three-phase capacitors, otherwise the device may not be able to detect connection faults, and alarm will be displayed.
- AUTO setup should be performed preferably at no load condition. However, the device is able to perform AUTO setup under stable load.

Fast varying loads may cause inaccurate detection of reactive power as well as auto correction failure. In such cases, auto setup should be repeated and measured step output ratings should be compared with actual capacitor/reactor banks. Step output ratings should be adjusted manually from front panel if required.

AUTO setup screen will be displayed when the device is energized. However below steps can be followed anytime in order to force a device to AUTO SETUP.





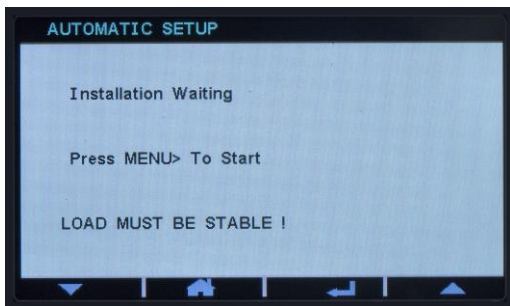

PROGRAMMING > ELECTRICAL PARAMETERS > PFC PARAMETERS > AUTO SETUP ACTIVE > YES

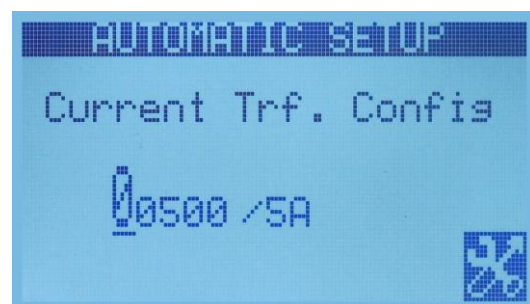
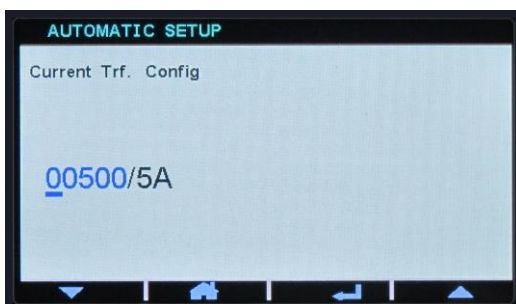
Below screen will be displayed once the device is energized. Press  () button once when the AUTO setup screen appears.



Once the below screen is displayed, current transformer ratio should be configured. Configure primary and secondary ratings of current transformers by   () and  () buttons and press  () button.



Once below screen displayed, the number of banks (step outputs) should be configured. Adjust number of step outputs by   ( ) buttons and press  () button.

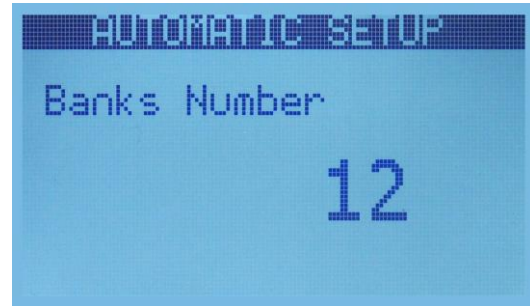
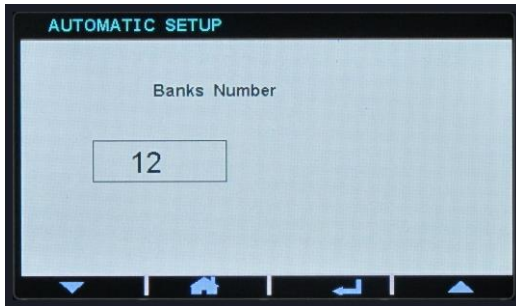

AUTO setup will start when above steps are performed. The device will energize first few banks to detect polarities of current transformers and phase order of voltage inputs. After that, the device will energize each bank independently to measure and record its reactive power rating.



Reactive power measured on each bank should be visually checked from front panel once AUTO setup is completed.

4. TERMINAL DESCRIPTIONS

4.1. SUPPLY VOLTAGE INPUT

Supply Voltage:	100-265VAC(\pm 15%), 50-60Hz (\pm 10%)
Maximum Input Power:	15 VA
Isolation:	3500VAC/1 minute from all other terminals.

4.2. AC VOLTAGE INPUTS

Measurement Method:	True RMS
Harmonic Analysis	Up to 31st harmonic
Measurement Range:	7 - 330VAC P-N (14 - 520VAC P-P)
Input Impedance:	4.5M-ohms
Display Resolution:	0.1VAC
Accuracy:	0.5% + 1 digit @ 230VAC ph-N (\pm 2VAC P-N) 0.5% + 1 digit @ 400VAC ph-ph (\pm 3VAC P-P)
Overload:	1300VAC (continuous)
Burden:	0.1VA max (per phase)
Frequency Range:	30 - 100 Hz
Frequency Display Resolution:	0.1 Hz
Frequency Accuracy:	0.2% + 1 digit

4.3. AC CURRENT INPUTS

Structure:	Isolated, internal current transformers
Measurement Method:	True RMS
Harmonic Analysis	Up to 31st harmonic
CT Secondary:	5A
Measurement Range:	5/5 - 10000/5A
Maximum Current:	6A continuous
Measurement Range:	0.003 - 6.5A AC
Display Resolution:	0.1A
Burden:	0.5VA max (per phase)
Accuracy:	0.5% + 1 digit
Isolation:	1000VAC/1minute from all other terminals.
Overload:	100A-AC for 1 second

SELECTING THE CT RATING AND CABLE SECTION:

The load on a CT should be kept minimum in order to minimize phase shift effect of the current transformer. Phase shift in a CT will cause erroneous power and power factor readings, although amp readings are correct.

Datakom advises CT rating to be selected following this table for the best measurement accuracy.

SELECTING THE CT ACCURACY CLASS:

The CT accuracy class should be selected in accordance with the required measurement precision. The accuracy class of the Datakom controller is 0.5%. Thus 0.5% class CTs are advised for the best result.

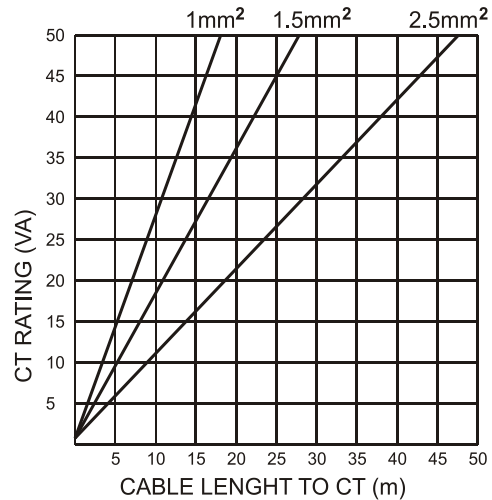

CONNECTING CTs:

Be sure of connecting each CT to the related phase input with the correct polarity. Mixing CTs between phases will cause faulty power and pf readings.

Many combinations of incorrect CTs connections are possible, so check both order of CTs and their polarity. Reactive power measurement is affected by incorrect CTs connection in similar way as active power measurement.

CORRECT CT CONNECTIONS

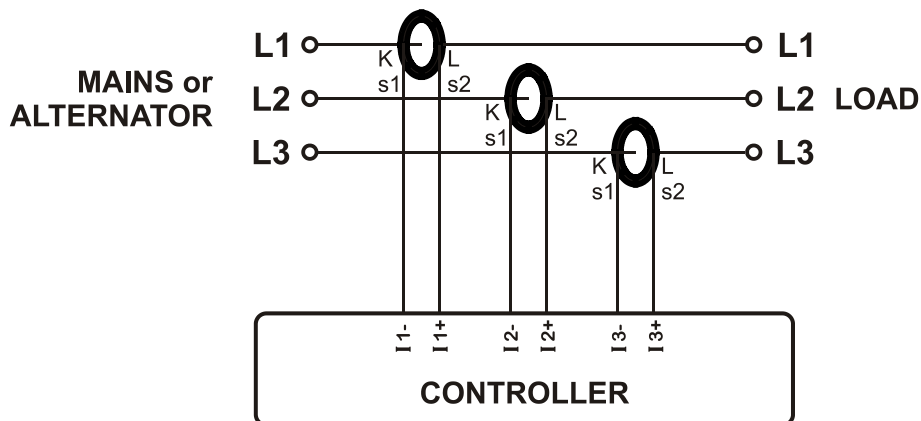

Let's suppose that the network is loaded with 100 kW on each phase. The load Power Factor (PF) is 1. Measured values are as follows:

	kW	kVAr	kVA	pf
Phase L1	100.0	0.0	100	1.00
Phase L2	100.0	0.0	100	1.00
Phase L3	100.0	0.0	100	1.00
Total	300.0	0.0	300	1.00

EFFECT OF POLARITY REVERSAL

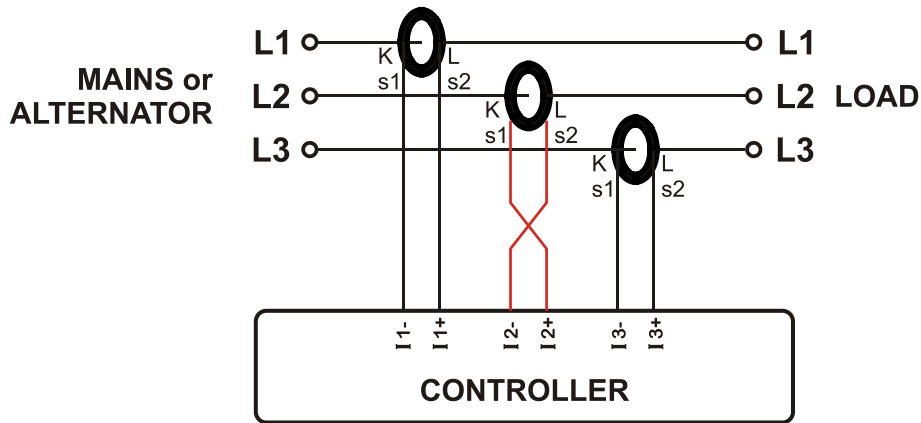

The network is still loaded with 100 kW on each phase. The load Power Factor (PF) is 1. PF in phase L2 will show -1,00 due to reverse CT polarity. The result is that total network power displayed by the controller is 100 kW. Measured values are as follows:

	kW	kVAr	kVA	pf
Phase L1	100.0	0.0	100	1.00
Phase L2	-100.0	0.0	100	-1.00
Phase L3	100.0	0.0	100	1.00
Total	100.0	0.0	300	0.33

EFFECT OF PHASE SWAPPING

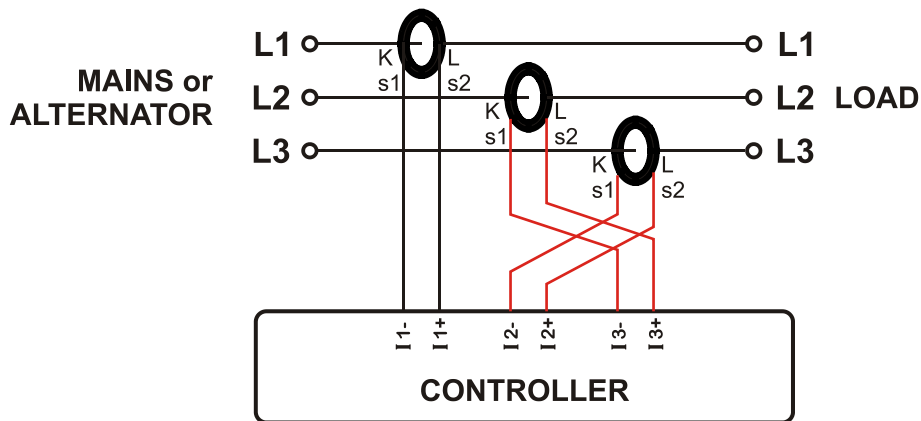

The network is still loaded with 100 kW on each phase. The load Power Factor (PF) is 1. PF in phases L2 and L3 will show -0,50 due to phase shift between voltages and currents which is caused by CT swapping. The result is that total network power displayed by controller is 0 kW. Measured values are as follows:

	kW	kVAr	kVA	pf
Phase L1	100.0	0.0	100	1.00
Phase L2	-50.0	86.6	100	-0.50
Phase L3	-50.0	-86.6	100	-0.50
Total	0.0	0.0	300	0.0

4.4. RELAY OUTPUTS

Structure:	Isolated relay outputs, normally open free contact.
Max Switching Current:	5A @250VAC/30VDC
Max Switching Voltage:	250VAC
Max Switching Power:	1250VA
Isolation:	2000VAC from all other terminals.

4.5. SVC OUTPUTS

Structure:	PNP transistor outputs protected with electronic fuse. Active level is +12VDC.
Max Output Current:	50mA
Parallel Connection:	2 units max

4.6. THYRISTOR OUTPUTS

Thyristor outputs are available for thyristor switched systems. (SSC)

Structure:	PNP transistor outputs protected with electronic fuse. Active level is +12VDC.
Max Output Current:	50mA
Parallel Connection:	2 units max

4.7. RS-485 PORT

Structure:	RS-485, isolated.
Connection:	3 wires (A-B-GND). Half duplex.
Baud rate:	2400-115200 baud, selectable.
Data Type:	8-bit data, no parity, 1 bit stop
Termination:	External 120 ohms required.
Isolation:	1000VAC from all other terminals.
Max Distance:	1200m @ 9600 baud (with 120 ohms balanced cable) 200m @ 115200 baud (with 120 ohms balanced cable)

The RS-485 port features MODBUS-RTU protocol. Multiple modules can be paralleled on the same RS-485 bus for data transfer to automation or building management systems.



The Modbus register list is available at the MODBUS section of this manual.

The RS-485 port provides also a good solution for distant PC connection where Rainbow Plus program will enable programming, control and monitoring.

RS-485 BUS STRUCTURE

A maximum of 32 devices can be paralleled on a RS-485 bus. For more devices on one bus, repeaters must be used.

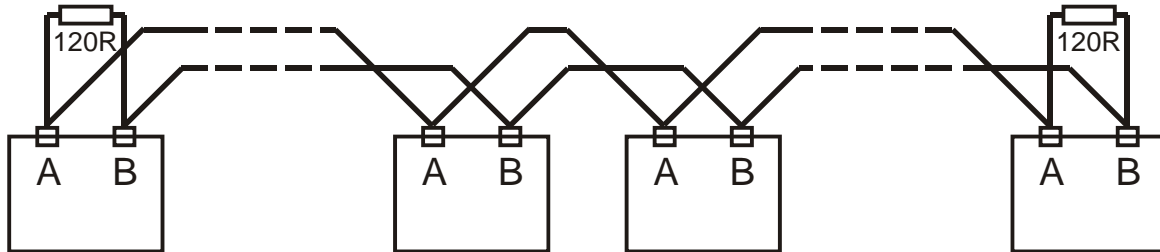

The bus must be terminated from both ends with 120-ohm resistor.

The cable shield should be grounded from one end only.



The device does not have any internal terminating resistors. External 120-ohm resistor should be added to both extremities of the bus line.

4.8. USB DEVICE PORT

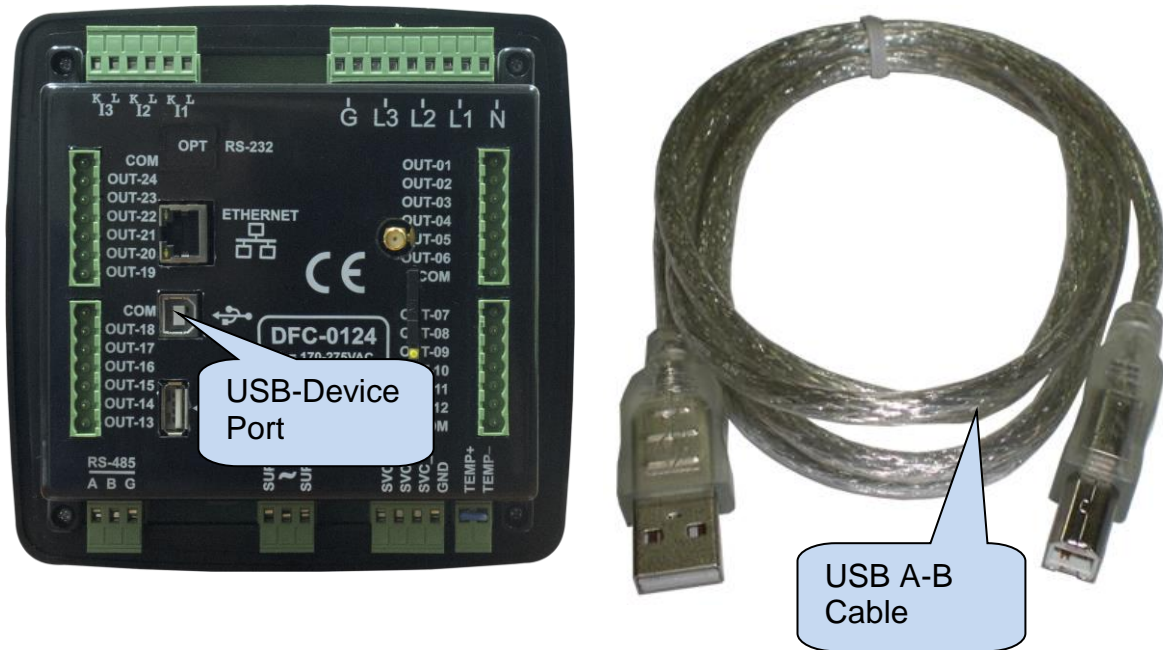

The USB-Device port is available in units with COMM option.

Description:	USB 2.0, not isolated, HID mode
Data Rate:	1.5/12 Mbit/s, auto detection
Connector:	USB-B (printer cable)
Cable Length:	Max 6m
Functionality:	Modbus, FAT32 for firmware update (boot mode only)

The USB-Device port is designed to connect the module to a PC. Using the Rainbow Plus software, programming, and monitoring of measured parameters are achieved.

The Rainbow Plus software can be downloaded from www.datakom.com.tr website.

For more details about programming, control and monitoring please refer to Rainbow Plus user manual.

4.9. USB HOST PORT



USB FLASH MEMORY

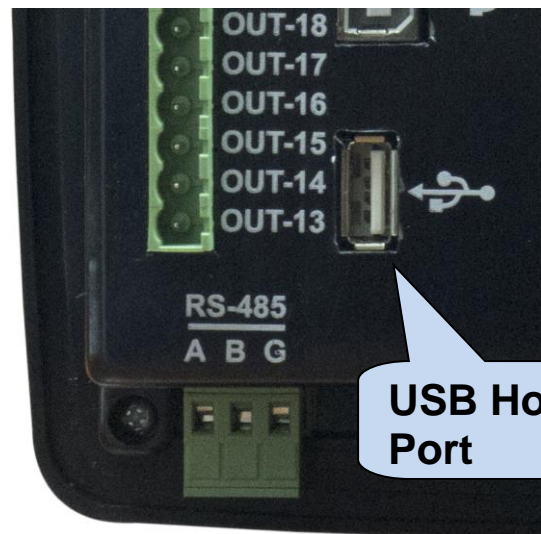

The USB-Host port is available in units with COMM option.

Description:	USB 2.0, not isolated
Power Supply Output:	5V, 300mA max.
Data Rate:	Full Speed 1.5/12 Mbits/s, auto detecting
Connector:	USB-A (PC type connector)
Cable Length:	Max 1.5m
Function:	USB memory, FAT32, data recording
Memory Capacity:	All USB flash memories.

The USB-Host port is designed for detailed data recording. The period of recording is adjustable through program parameter.

As USB flash memory is inserted, the unit will start data recording and continue until the flash memory is removed.

For more details about data recording, please review chapter “Data Recording”.



If USB-Device is plugged, then USB-Host port will not function.

4.10. ETHERNET PORT

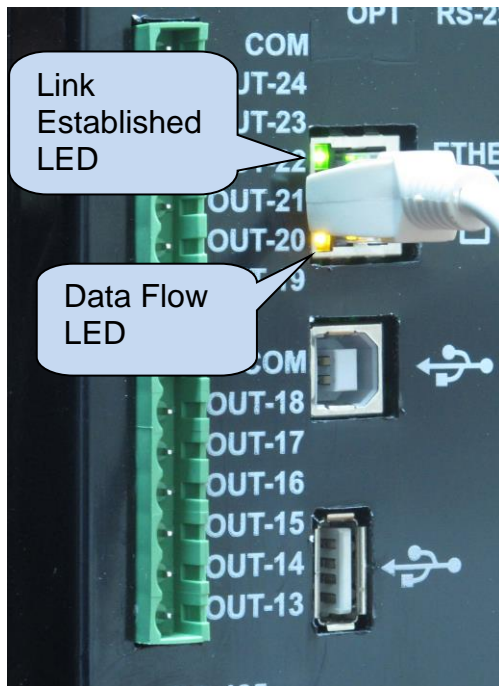

Description:	IEEE802.3 compliant, 10/100 Base-TX RJ45 ethernet port with indicating leds
Data Rate:	10/100 Mbits/s, auto detecting
Cable Type:	CAT5 or CAT6
Isolation:	1500 VAC, 1 minute
Max Distance:	30m
Function:	Embedded TCP/IP, Web Server, Web Client, SMTP, e-mail, SNMP, Modbus TCP_IP

STANDARD ETHERNET CABLE



LED FUNCTIONS:

GREEN: This led turns on when the ethernet link is established (connector inserted)

YELLOW: This led blinks when data transfer occurs inwards or outwards. Periodic blinking will witness data flow.

4.11. GSM MODEM

The optional internal GSM modem offers the advantage of being internally powered and is fully compatible with the unit. It does not require any special setup.

The 1800/1900 MHz magnetic antenna together with its 2 meter cable is supplied with the internal modem option. The antenna is intended to be placed outside of the panel for the best signal reception.

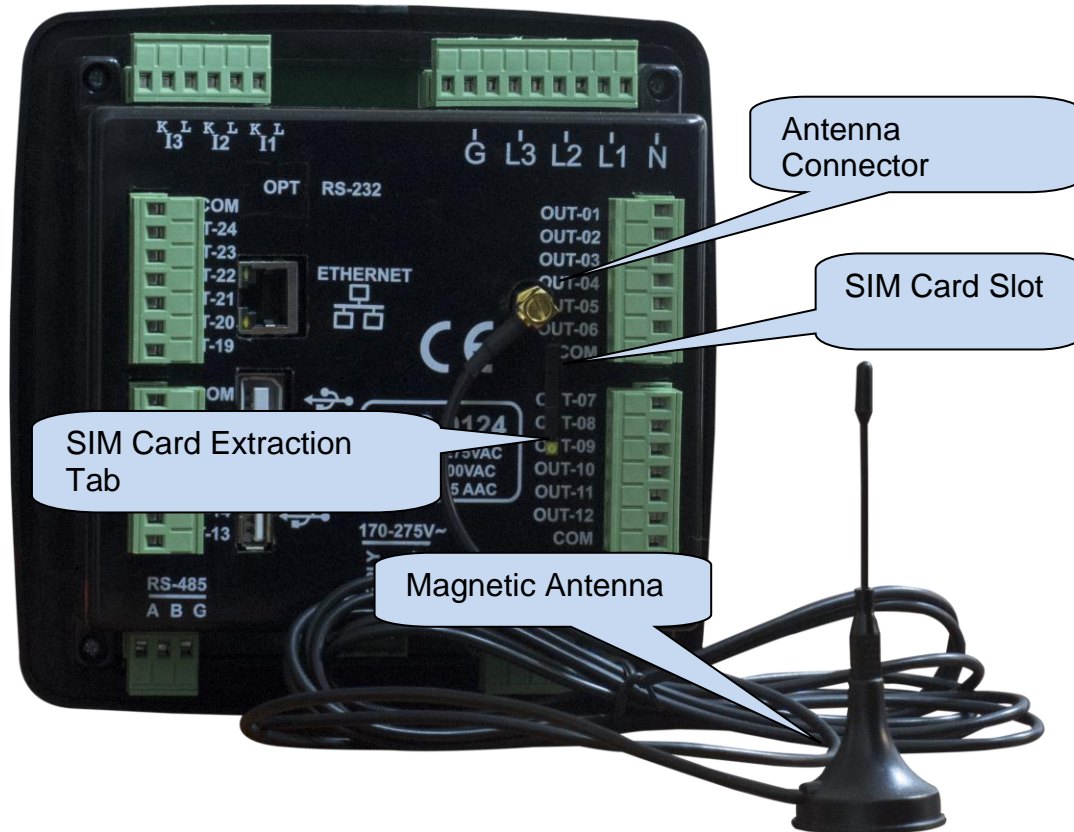

The module requires a GPRS enabled SIM card for full functionality. Voice-only type SIM cards will usually not function properly.

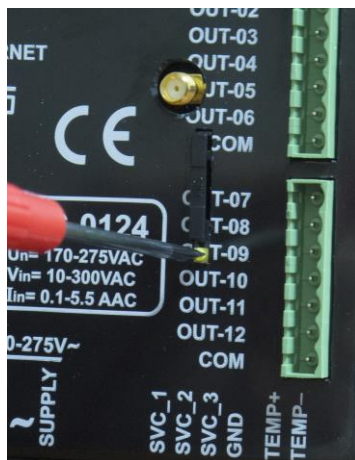

SIM CARD EXTRACTION

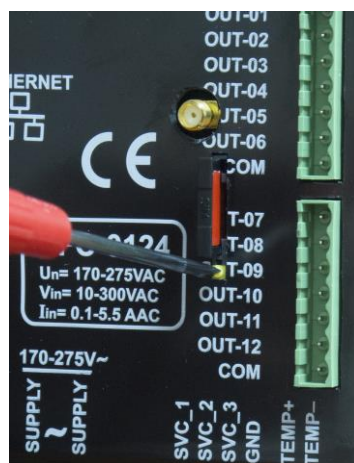

SIM CARD EXTRACTION/INSERTION

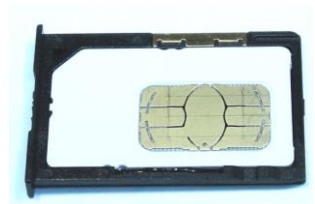

SIM CARD

Description:	Quad-band GSM/GPRS 850/900/1800/1900MHz module. GPRS multi-slot class 12/12 GPRS mobile station class B Compliant to GSM phase 2/2+. – Class 4 (2 W @ 850/ 900 MHz) – Class 1 (1 W @ 1800/1900MHz)
Functionality:	Web Client, SMTP, Modbus TCP/IP (client), SMS, e-mail
Operating temp range:	-40°C to +85 °C
Data speed:	max. 85.6 kbps (download), 85.6 kbps (upload)
SIM card type:	external SIM 3V/1.8V, GPRS enabled
Antenna:	Quad band, magnetic, with 2m cable
Module certificates:	CE, FCC, ROHS, GCF, REACH

LOCATION DETERMINATION VIA GSM

The unit determines automatically the geographical position through the GSM network. No settings are necessary for this.



The location precision will depend of the GSM system. In highly populated areas, the precision is good (a few hundred meters), but rural areas may lead to errors of a many kilometers.

5. CONNECTION DIAGRAM

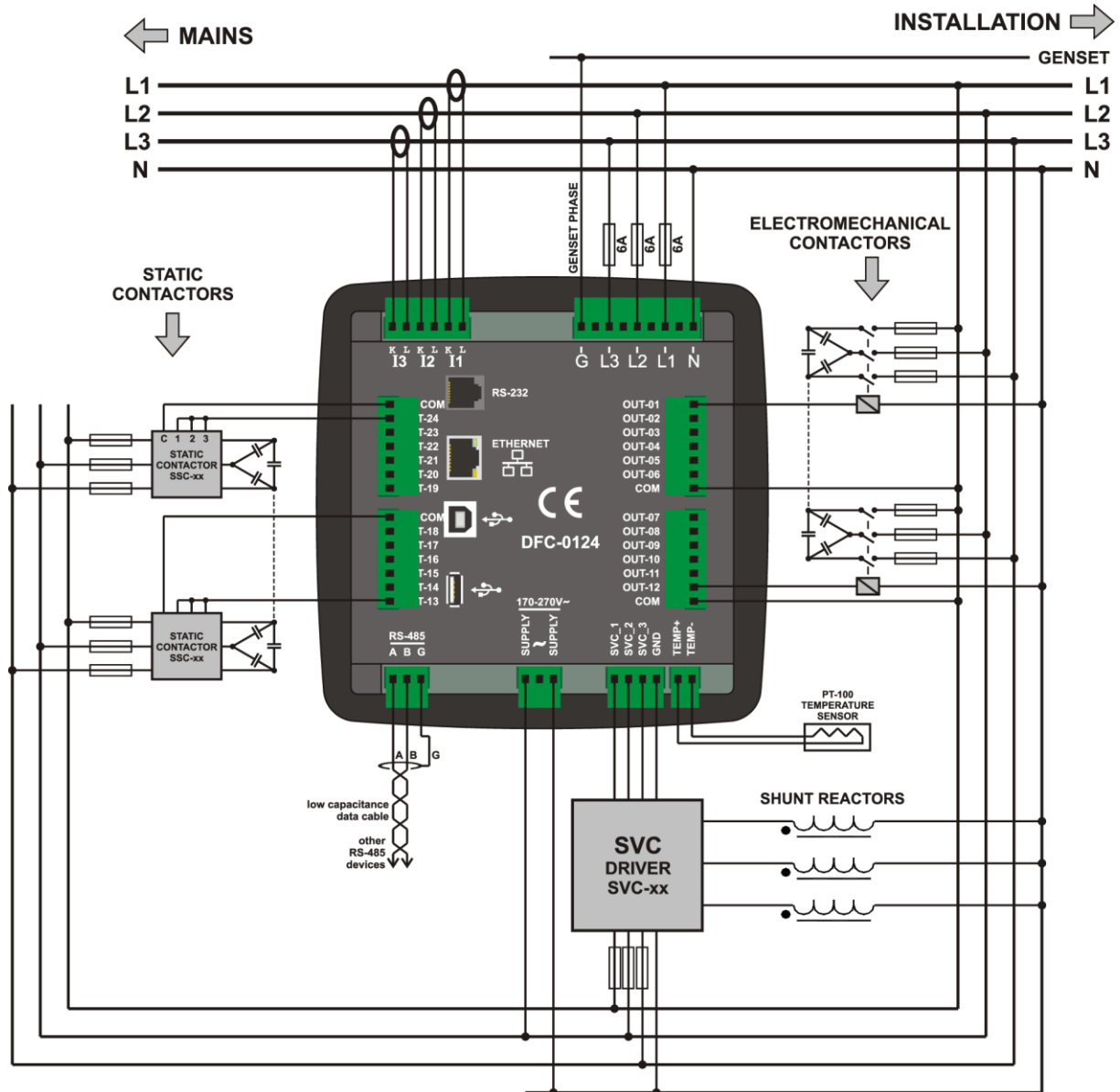

6. TECHNICAL SPECIFICATIONS

Power Supply Input:	100-265V AC ($\pm 15\%$), 50/60Hz ($\pm 10\%$)
Power Consumption:	<15 VA
Measurement Input Range:	
Voltage:	5 - 300 V AC (P-N) 10 - 520 V AC (P-P)
Current:	0.003 – 6.5 A AC
Frequency:	30 - 100 Hz
Accuracy:	
Voltage:	0.5% + 1 digit
Current:	0.5% + 1 digit
Frequency:	0.2% + 1 digit
Power:	1.0% + 2 digit
Cos:	0.5% + 1 digit
Measurement Range:	
CT Range:	5/5A - 10000/5A
VT Range:	0.1/1 - 5000.0/1
kW Range:	0.1 kW to 50 MW
Voltage Burden:	< 0.1VA per phase
Current Burden:	< 0.5VA per phase
Relay Outputs:	5A @ 250V AC
Static Contactor Outputs:	50mA @ 12 VDC
Temperature Input:	PT100 sensor or switch (selectable)
Operating Temperature:	-20°C to +70 °C
Maximum Humidity:	95%, non-condensing
Degree of Protection:	IP 54 (Front Panel) / IP65 (Front panel with gasket) IP 30 (Back)
Enclosure:	Non-flammable, ROHS compliant
Installation:	Flush mounting with rear brackets
Dimensions:	164x164x69mm (WxHxD)
Panel Cutout:	140x140mm
Weight:	500 gr
<u>EU Directives:</u>	<u>Norms of Reference:</u>
2006/95/EC (LVD)	EN 61010 (safety)
2004/108/EC (EMC)	EN 61326 (EMC)

7. TERMINAL DESCRIPTION

Term	Function	Technical Data	Description
	SUPPLY	100-265VAC	Connect power supply input.
	-	-	Do not connect this terminal.
	SUPPLY	100-265VAC	Connect power supply input.

Term	Function	Technical Data	Description
	L1	Voltage inputs, 5-300V-AC	Connect voltage measurement inputs.
	L2		
	L3		
	NEUTRAL	Input, 5-300V-AC	Connect neutral terminal.

Term	Function	Technical Data	Description
	CURR_1_L	Current transformer inputs, 5A-AC	Connect current transformer terminals to these inputs. Do not connect the same current transformer to other instruments otherwise a unit fault will occur. Connect each terminal of the transformer to the unit's related terminal.
	CURR_1_K		
	CURR_2_L		
	CURR_2_K		
	CURR_3_L		
	CURR_3_K		

Term	Function	Technical Data	Description
	RS-485 A	Digital communication port	Connect the A-B data lines of the RS-485 link to these terminals.
	RS-485 B		
	PROTECTION GROUND	Output 0Vdc	Connect the protective shield of the MPU and CANBUS-J1939 cables to this terminal, from one end only.

Term	Function	Technical Data	Description
	OUT 1	Relay outputs 5A @ 250 VAC	Connect to contactor coils.
	OUT 2		
	.		
	COM	Common terminal	Connect any phase.

Term	Function	Technical Data	Description
	THYRIS 1	Static contactor outputs 50 mA @ 12 VDC	Connect trigger input of static contactor.
	THYRIS 2		
	.		
	COM	Common terminal	Connect common terminal of static contactor.







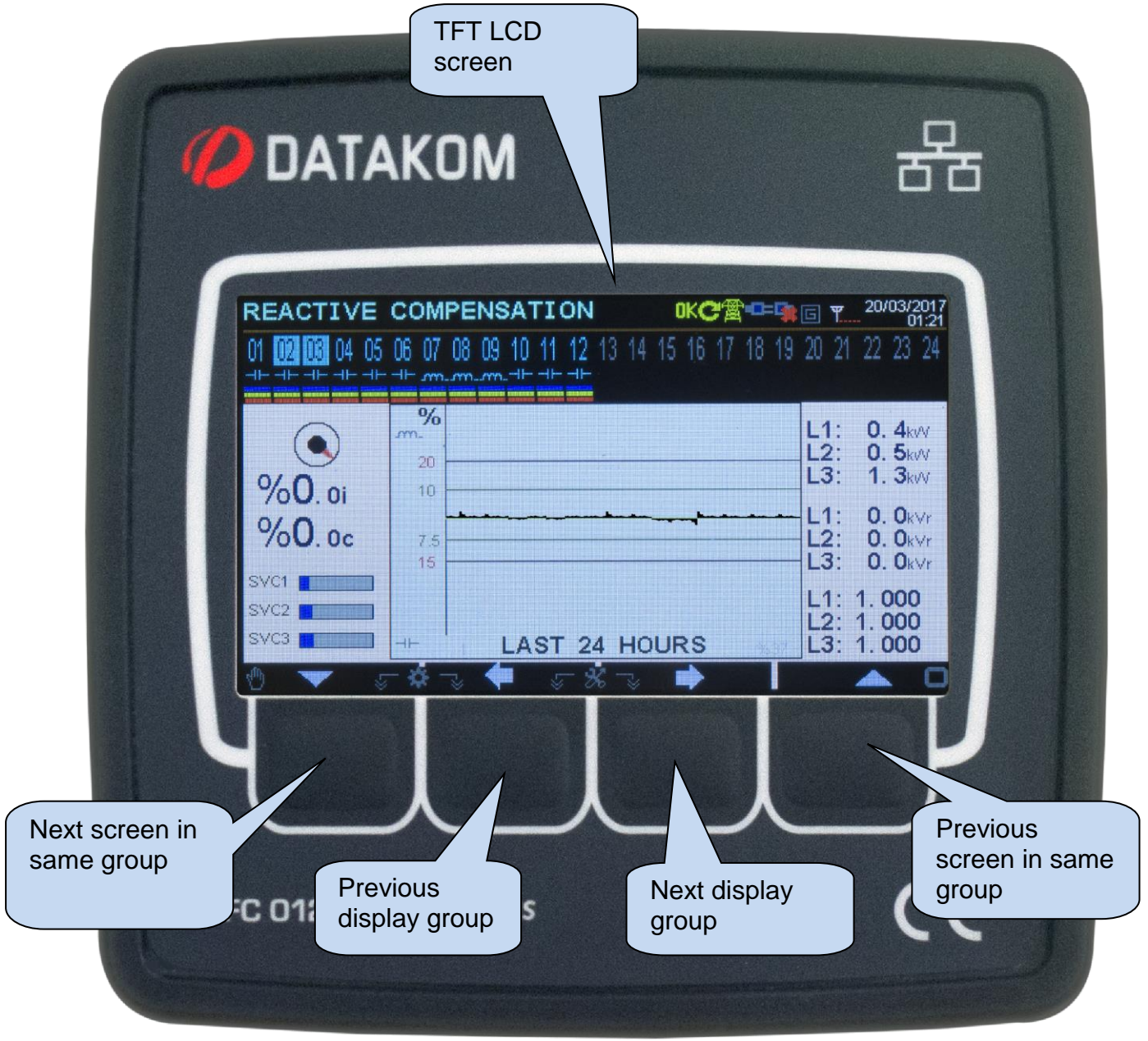











Term	Function	Technical Data	Description
	SVC1	SVC outputs 50 mA @ 12 VDC	Connect triggering input of SVC.
	SVC2		
	SVC3		
	GND	Common terminal	Connect common terminal of SVC.

8. DESCRIPTION OF CONTROLS

8.1. FRONT PANEL FUNCTIONALITY



8.2. PUSHBUTTON FUNCTIONS

BUTTON		FUNCTION
		Previous display group.
		Next display group.
		Next screen in same display group, or decrease selected value. (programming mode)
		Previous screen in same display group, or increase selected value. (programming mode)
		<u>HELD PRESSED FOR 5 SECONDS:</u> Enters programming mode. Exits programming mode if held pressed in programming mode.
		<u>HELD PRESSED FOR 5 SECONDS:</u> Switches between AUTO and TEST modes. Compensation is disabled in TEST mode.
		<u>HELD PRESSED FOR 5 SECONDS:</u> Current screen will be default display screen.
		Remove alarms on screen.
		<u>HELD PRESSED FOR 5 SECONDS:</u> Remove alarms. Alarms will reappear if alarm condition occurs.

9. MEASURED PARAMETERS

The unit performs a detailed set of AC measurements.

The list of measured parameters is below :

L1-N voltage	L2 reactive power (kVAr)
L2-N voltage	L3 reactive power (kVAr)
L3-N voltage	L1 apparent power (kVA)
L1-L2 voltage	L2 apparent power (kVA)
L2-L3 voltage	L3 apparent power (kVA)
L3-L1 voltage	L1 power factor (pf)
Average Ph-N voltage	L2 power factor (pf)
Average Ph-Ph voltage	L3 power factor (pf)
L1 current	
L2 current	<u>Harmonic analysis channels:</u>
L3 current	L1-N voltage
Neutral current	L2-N voltage
Average current	L3-N voltage
Frequency (Hz)	L1-L2 voltage
Total active power	L2-L3 voltage
Total reactive power	L3-L1 voltage
Total apparent power	L1 current
Total power factor	L2 current
L1 active power (kW)	L3 current
L2 active power (kW)	
L3 active power (kW)	
L1 reactive power (kVAr)	

10. INDICATOR SYMBOLS

SYMBOL	DEFINITION
Ver	Firmware
U12	Phase 1 - Phase 2 AC RMS Voltage
U23	Phase 2 - Phase 3 AC RMS Voltage
U31	Phase 3 - Phase 1 AC RMS Voltage
FRQ	Frequency
V1	Phase 1 - Neutral AC RMS Voltage
V2	Phase 2 - Neutral AC RMS Voltage
V3	Phase 3 - Neutral AC RMS Voltage
I1	Phase 1 AC RMS Current
I2	Phase 2 AC RMS Current
I3	Phase 3 AC RMS Current
P1	Phase 1 Active Power (kW)
P2	Phase 2 Active Power (kW)
P3	Phase 3 Active Power (kW)
ΣP	Total Active Power (kW)
Q1	Phase 1 Reactive Power (kVar)
Q2	Phase 2 Reactive Power (kVar)
Q3	Phase 3 Reactive Power (kVar)
ΣQ	Total Reactive Power (kVar)
S1	Phase 1 Apparent Power (kVA)
S2	Phase 2 Apparent Power (kVA)
S3	Phase 3 Apparent Power (kVA)
ΣS	Total Apparent Power (kVA)
PF1	Phase 1 Power Factor
PF2	Phase 2 Power Factor
PF3	Phase 3 Power Factor
PF	Total Power Factor
I1mx	Phase 1 Maximum Current
I2mx	Phase 2 Maximum Current
I3mx	Phase 3 Maximum Current
Pmax	Total Maximum Active Power
Plm1	Import Power Counter 1 (kWh)
PEx1	Export Power Counter 1 (kWh)
Plm2	Import Power Counter 2 (kWh)
PEx2	Export Power Counter 2 (kWh)
QIn1	Inductive Power Counter 1 (kVar)
QCp1	Capacitive Power Counter 1 (kVar)
QIn2	Inductive Power Counter 2 (kVar)
QCp2	Capacitive Power Counter 2 (kVar)
THD	Total Harmonic Distortion
Th...	Total Harmonic of ... (V1,V2,V3,I1,I2,I3,U1,U2,U3)
H03-H31	Harmonics

11. WAVEFORM DISPLAY & HARMONIC ANALYSIS

The unit features waveform display together with a precision harmonic analyzer for both voltages and currents. Both phase to neutral and phase to phase voltages are available for analysis.

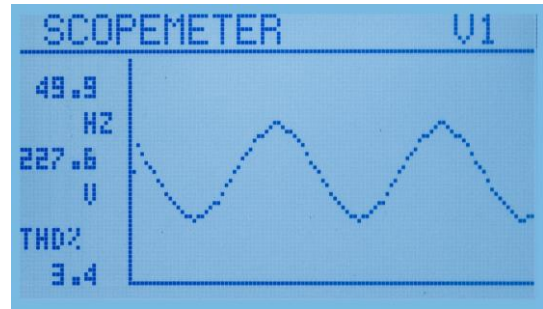
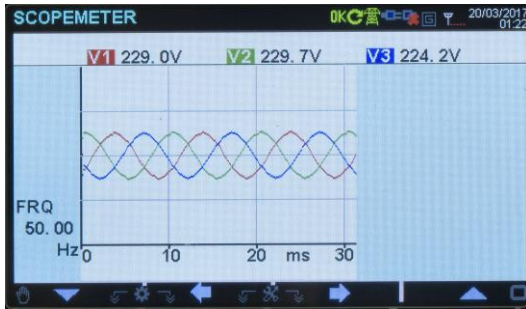

Scope meter Screen

The waveform display memory is of 100 samples length and 12-bit resolution, with a sampling rate of 2048 s/s. Thus, one cycle of a 50Hz signal is represented with 41 points. The vertical scale is automatically adjusted in order to avoid clipping of the signal.

The waveform is displayed on the device screen, and with more resolution on PC screen through the Rainbow Plus program.

The display memory is also available in the Modbus register area for third party applications. For more details please check chapter “**MODBUS Communications**”.

The harmonic analyzer consists of a Fast Fourier Transform (FFT) algorithm which is run twice a second on the selected parameter.

The sample memory is 1024 samples length and 12 bits resolution with a sampling rate of 8192 s/s.

The unit is able to analyze up to 1550Hz and up to 31st harmonic, whichever is smaller.

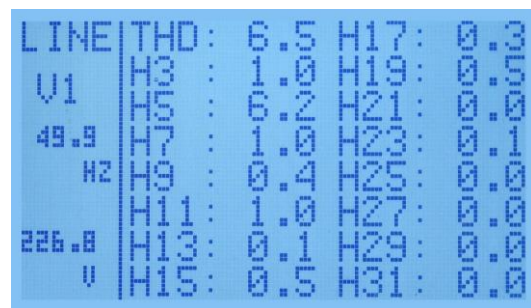

Harmonics Display Screens

All harmonics are displayed with 0.1% resolution.

On Rainbow Plus program, harmonics and waveform are displayed with more resolution.

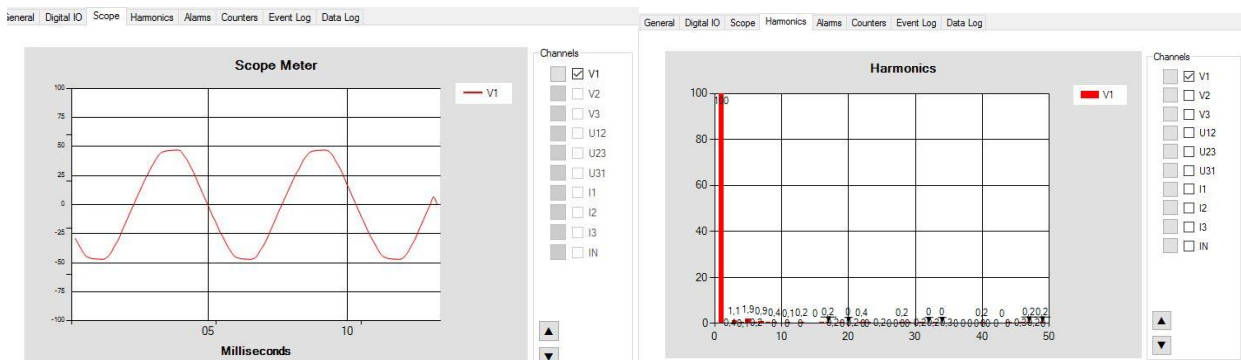

Rainbow Plus Scada section: Waveform Display and Harmonics

12. DISPLAYING EVENT LOGS

The unit features more than 200 event logs with date-time stamp and full snapshot of measured values at the moment that the event has occurred.

Stored values in an event record are listed below:

- event number
- event type / fault definition (see below for various event sources)
- date and time
- binary values of all alarm, input and output bits.
- Ph-N voltages: V1-V2-V3
- Ph-Ph voltages: U12-U23-U31
- Phase currents: I1-I2-I3
- frequency
- total active power (kW)
- total reactive power (kVAr)
- total apparent power (kVA)
- total power factor
- Total harmonic distortion: V1-V2-V3-U12-U23-U31-I1-I2-I3

Possible event sources are various. Every source can be individually enabled or disabled:

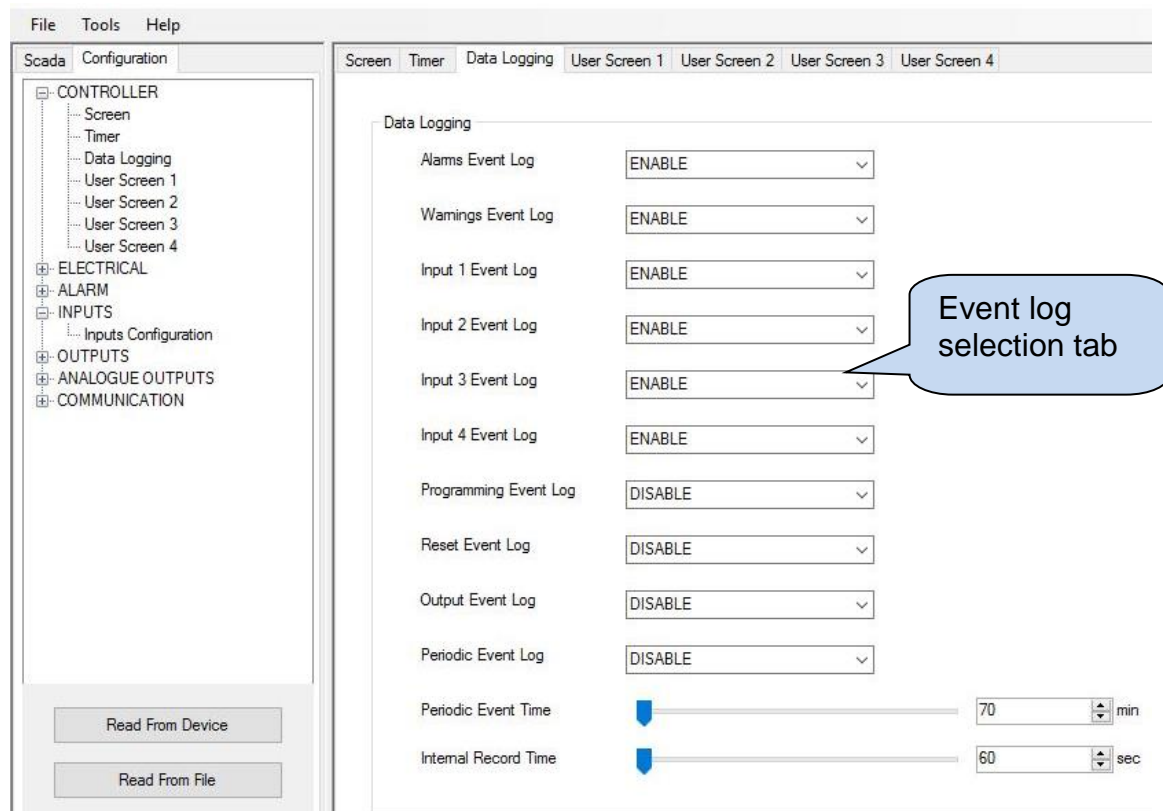

Alarm events: recorded when the related fault condition occurs.

Warning events: recorded when the related warning condition occurs.

Input events: recorded when the status of a digital input is changed.



Programming event: Recorded with the password level when program mode is entered.

Reset event: recorded when device reset.

Output event: recorded when the status of a digital output changes.

Periodic event: records measurements and parameters with specified time periods.

Event logs are displayed within the program mode menu. This is designed in order to reduce the interference of event logs with other measurement screens.

To monitor event logs, hold pressed  and  (↶ and ↷) buttons for 5 seconds.

When the program mode is entered, below password entry screen will be displayed.

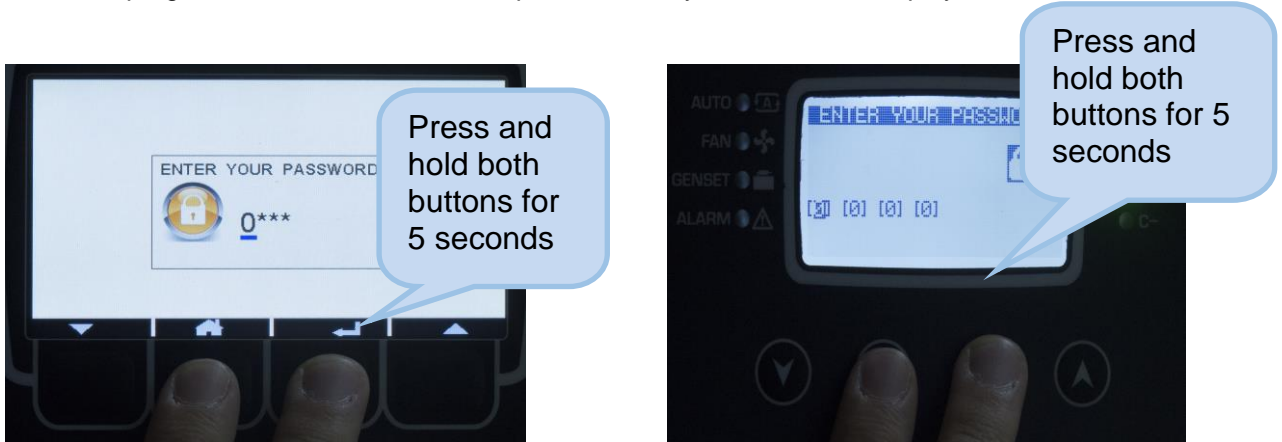

Type password as “9876” by using  and  (↶↷) buttons to increase or decrease the number in highlighted digit, press  (↶) button to type the next digit. Press  (↶) button to enable programming mode.

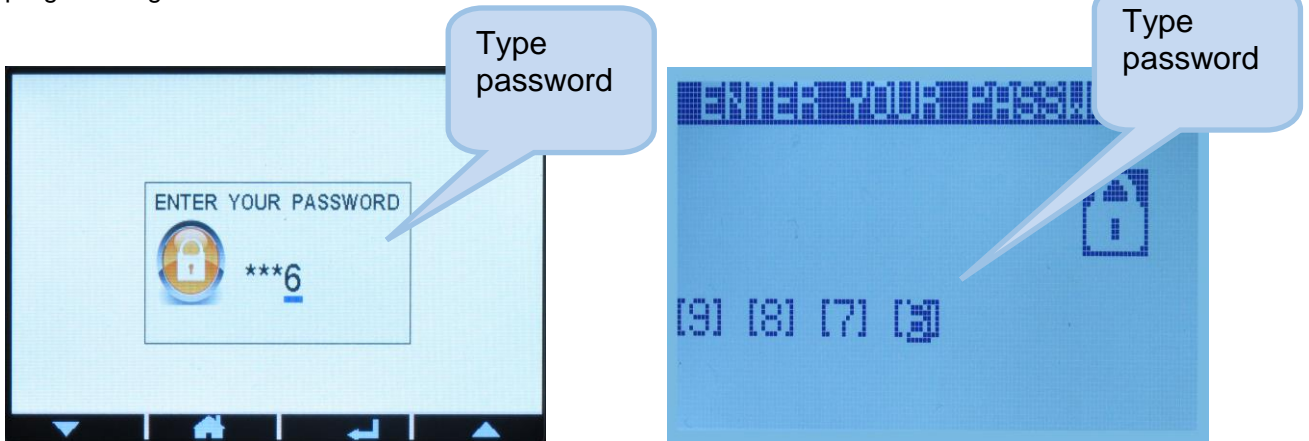



Press  (↶) button again to see the last stored event. The first page will display the event number, event type, fault type and date-time information.

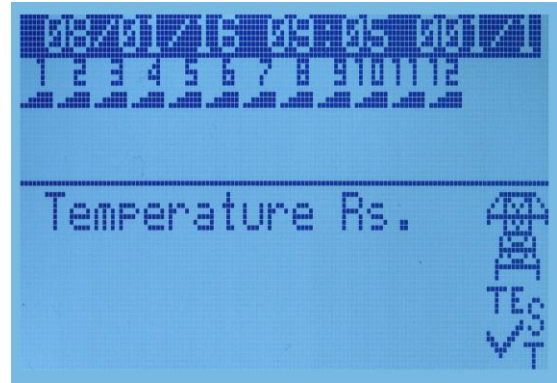



When displaying event logs:

-  button will display the next information in the same event, when held pressed returns to the main programming screen.
-  button will display the same information of the previous event.
-  button will display the same information of the next event.

13. COUNTERS

The unit provides a set of non-resettable incremental counters for statistical purposes.

Available Counters:

- Total import kWh-1
- Total export kWh-1
- Total inductive kVArh-1
- Total capacitive kVArh-1

- Total import kWh-2
- Total export kWh-2
- Total inductive kVArh-2
- Total capacitive kVArh-2

14. DEMAND MEASUREMENT

Demand values are average values of measured parameters over a specified time period.

The average values at the end of the period are compared with the demand registers, if higher, the new demand is stored into the register.

Demand registers are reset at the beginning of each month. Therefore, demands are effective for the current month.

Demands can be reset manually by "Restart All Counters" section on programming.

Demand registers are stored in a non-volatile memory and retain their values even when power is off.

Below demand measurements are available:

- demand I1
- demand I2
- demand I3
- demand Ia (average current)
- demand import active power
- demand export active power

15. MIN-MAX MEASUREMENT

Min-max values are based on instantaneous measurements. They have no averaging periods. Therefore, excessive values may be stored during short duration peak demands, like electric motor starts or inrush currents that flow at power-on.

During operation, the unit compares the instantaneous value with the storage registers, if higher, the new value is stored into the register.

Min-max registers are reset through programming mode. The related parameter is:

COUNTER/MIN/MAX>Restart Min/Max

Min-max registers are stored in a non-volatile memory and retain their values even when power is off.

For stability purposes, the min-max detection starts 5 seconds after power turns on.

Below min-max registers are available

-Min voltage L1-N	-Max voltage L1-N
-Min voltage L2-N	-Max voltage L2-N
-Min voltage L3-N	-Max voltage L3-N
-Min voltage L1-2	-Max voltage L1-2
-Min voltage L2-3	-Max voltage L2-3
-Min voltage L3-1	-Max voltage L3-1
-Min frequency	-Max frequency
-Min current I1	-Max current I1
-Min current I2	-Max current I2
-Min current I3	-Max current I3
-Min current Ia (average current)	-Max current Ia (average current)
-Min import active power	-Max import active power
-Min export active power	-Max export active power
-Min inductive reactive power	-Max inductive reactive power
-Min capacitive reactive power	-Max capacitive reactive power

16. PROTECTION AND ALARMS

Measured analog values outside of programmed limits cause an ALARM condition.

In case of an alarm, pop-up screen will appear and alarm relay will be active. In order to interact with other systems, any relay output of the device can be assigned as alarm.



If a fault condition occurs, pop-up screen will appear automatically.

Alarms may be of **LATCHING** type following programming. For latching alarms, even if the alarm condition is removed, the alarms will stay on.

Most alarms have programmable trip levels. See the programming chapter for adjustable alarm limits.

17. PROGRAMMING

The program mode is used to adjust timers, operational limits and the configuration of the unit. Although a free PC program is provided for programming, every parameter may be modified through the front panel, regardless of the operating mode.







Program parameters will be automatically recorded into a non-erasable memory and take effect immediately after modification.







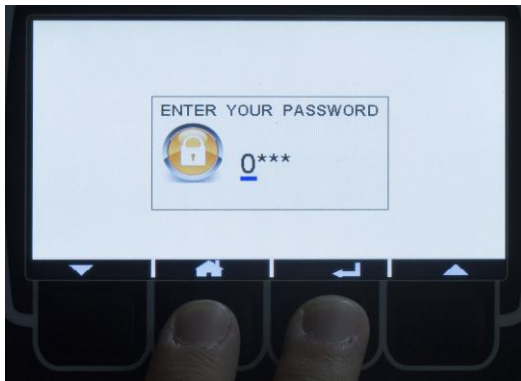

Programming mode will not affect the operation of the unit.

17.1. ENTERING THE PROGRAMMING MODE

Press and hold  and  ( and ) buttons to enter programming mode. When the programming mode is enabled, below screen will be displayed to enter password.



4-digit password must be entered with   ( ) and  () buttons.

  ( ) buttons modify the value of the current digit.  () button navigates to the next digit.

The unit supports 3 password levels. The level_1 is designed for field adjustable parameters. The level_2 is designed for factory adjustable parameters. The level_3 is reserved. It allows recalibration of the unit.











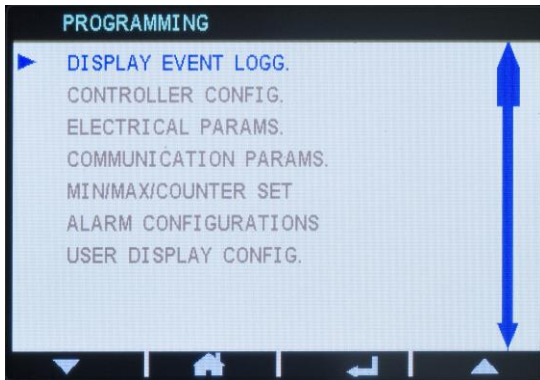



Level-1 password is '1234' ve Level-2 password is '9876'

17.2. NAVIGATING BETWEEN MENUS





The program mode is driven with a two-level menu system. The top menu consists on program groups and each group consists on various program parameters.

When programming mode is enabled, a list of available groups will be displayed. Navigation between different groups are made with  () and  () buttons. Selected group is shown in a different color. In order to enter inside a group, please press  () button.



Navigation inside a group is also made with  and  ( and ) buttons. A list of available parameters will be displayed on the screen. Selected parameter is shown in white on black. In order to display/change the value of this parameter, please press  () button. Parameter value may be increased and decreased with  and  ( and ) buttons. When a program parameter is modified, it is automatically saved in memory. If  () button is pressed, next parameter will be displayed.

17.3. MODIFYING PARAMETER VALUE

Parameter values can be increased or decreased with  and  ( and ) buttons. When a program parameter is modified, it is automatically saved in memory. If  () button is pressed, next parameter will be displayed.

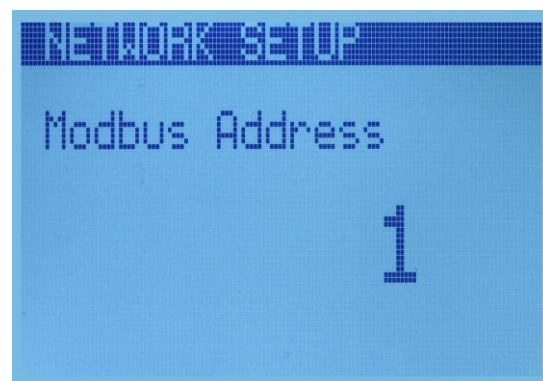
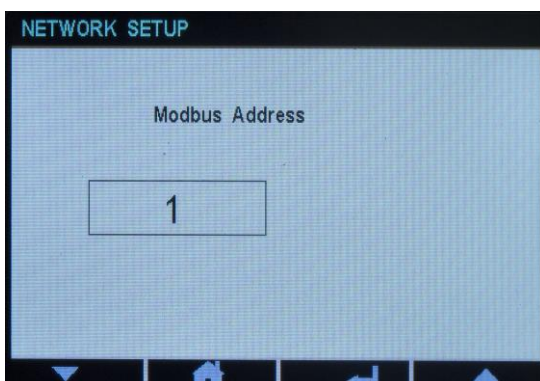

17.4. PROGRAMMING MODE EXIT

To exit programming mode, press  and  (↶ and ↷) buttons together with 5 seconds.

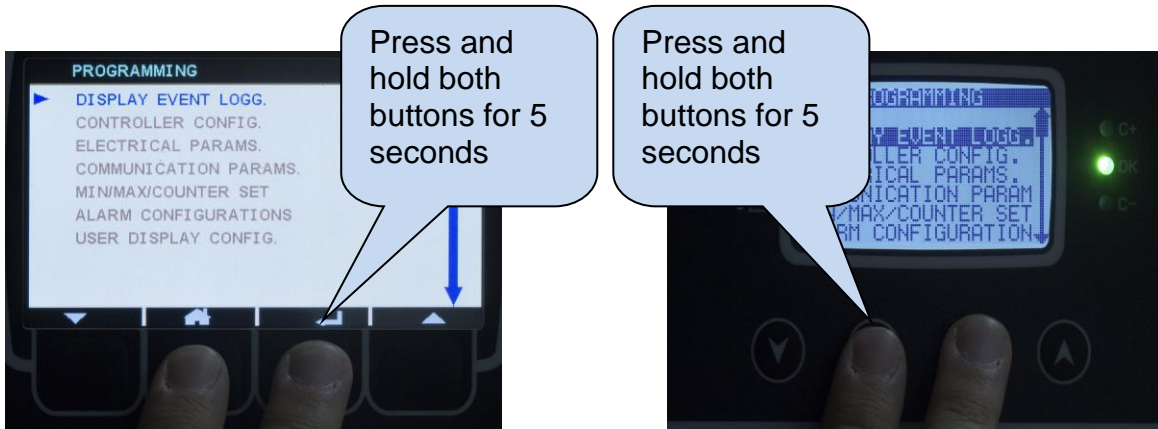

 **Device will automatically disable programming mode, if no action is taken for 2 minutes.**

18. PROGRAMMING PARAMETER LIST

18.1. CONTROLLER CONFIGURATION GROUP

Parameter Definition	Unit	Min	Max	Factory Set	Description
LCD Contrast	-	30	55	39	This parameter is used to set LCD contrast. Adjust for the best viewing angle.
Screen Scroll Timer	sec	0	250	0	Delay for automatic switch between screens.
Language	-	0	1	1	0: English 1: Turkish (This language may depend on the country where the unit is intended to be used.) Different languages can be uploaded by Rainbow Plus.
GSM Location Active	-	0	1	1	0: Disabled 1: Enabled Location information is obtained by using GSM.
Log Record Period	sec	10	65535	10	Log record period to USB flash memory.
Real Time Clock Adjust	-	0	255	117	Determines speed of real time clock.
LCD Backlight Timer	min	0	1440	1	If no button is pressed during this period, then the unit will reduce the LCD screen backlight intensity.
Fahrenheit Display	-	0	1	0	0: Temperature will be displayed as Celsius. 1: Temperature will be displayed as Fahrenheit.
Internal Record Timer	sec	5	65535	360	Log record period to internal memory.
Calibration Parameters	-	-	-	-	Calibration coefficients of voltages and currents for each phase are held.
Time & Date Config	-	-	-	-	It is used to adjust date and time of the device.
Change Password	-	-	-	-	It is used to change Level 1 and Level 2 password.
Location Setup	-	-	-	-	It is used to change longitude, latitude and time zone parameters.
Return to Factory	-	-	-	-	It is used to return factory settings, which will reset learned banks, counters and current transformers settings.

18.2. ELECTRICAL PARAMETERS GROUP

Parameter Definition	Unit	Min	Max	Factory Set	Description
PFC Parameters	-	-	-	-	Parameter group related with compensation.
User Output Config	-	-	-	-	Parameter group related with user defined relay or thyristor outputs.
Relay Parameters	-	-	-	-	Parameter group related with relay outputs.
Thyristor Parameters	-	-	-	-	Parameter group related with thyristor outputs.
SVC Parameters	-	-	-	-	Parameter group related with SVC outputs.

18.2.1 PFC PARAMETERS GROUP

Parameter Definition	Unit	Min	Max	Factory Set	Description
Mode Change	-	0	1	0	Switches between AUTO and TEST mode. Compensation is disabled in TEST mode.
Learn All	-	0	1	0	Step outputs will be tested and reactive power of each output will be learned.
Auto Setup Active	-	0	1	0	Auto setup will be active.
Current Trf. Config	-	5/5	500/5	20000/5	Primary and secondary ratings of current transformers must be configured.
Voltage Transf. Ratio	-	0.1	5000	1.0	Voltage transformer ratio must be configured.
Target Cos 1	-	-0,800	0,800	1.000	Target power factor can be adjusted as capacitive or inductive. Negative Cos means capacitive load characteristics where positive Cos means inductive load characteristics.
Target Cos 1 Range	%	0.0	39.9	0.5	If power factor of the load is in range specified by "Target Cos 1 Range", then DFC0124 will not take further action to reduce reactive power.
Target Cos 2	-	-0,800	0,800	1.000	It is possible to define an alternative power factor for generator mode operation. If 230 VAC is applied to the generator input terminal of DFC0124, device will operate by considering "Target Cos2".
Target Cos 2 Range	%	0.0	39.9	0.5	If power factor of the load is in range specified by "Target Cos 2 Range", then DFC0124 will not take further action to reduce reactive power.
Nominal Voltage	V	0	65500	230	Nominal phase-neutral voltage must be adjusted.
Nominal Frequency	Hz	10	400	50	Nominal frequency must be adjusted.
Month Start Date	-	1	31	1	Invoice date must be adjusted.

Comp. Ok LED Ratio	%	1	50	10	Compensation OK led will flash, if reactive power ratio is less than the limit defined by "Comp. Ok LED Ratio".
Elect. Meter Type	-	0	1	1	0: Analog Meter 1: Digital Meter
Phase Order Check	-	0	1	0	Phase order alarm will appear if phase order of mains changes.
Daily Ind. Range	%	5	50	15	If daily inductive ratio exceeds "Daily Ind. Range", device will issue an alarm.
Daily Cap. Range	%	5	50	15	If daily capacitive ratio exceeds "Daily Cap. Range", device will issue an alarm.
Monthly Ind. Range	%	5	50	15	If monthly inductive ratio exceeds "Monthly Ind. Range", device will issue an alarm.
Monthly Cap. Range	%	5	50	15	If monthly capacitive ratio exceeds "Monthly Cap. Range", device will issue an alarm.
Test & Fix Connection	-	0	1	0	Performs automatic correction for phase order error of voltage inputs and polarity error of current transformers.
Const Reactive Load	kVAr	-3276	3276	0	Adjusted amount of reactive power will not be compensated by DFC0124.
Without Capacitor	-	0	1	0	This parameter should be active in order to complete auto setup for the systems consists of reactors only.
Stop Comp for Genset	-	0	1	0	Compensation will stop if 230VAC applied to the genset input of DFC0124

18.2.2 USER OUTPUT CONFIGURATION

Up to 6 outputs can be configured as alarm relay output. Output number and function must be specified. List of available functions are as follows;

Compensation OK	Cos Insufficient Compensation
Compensation Not OK	High Current
Compensation Error	High THDV
kW Tick	High THDI
kVAR Tick	Voltage Unbalance
Not 3 Phase	Current Unbalance
1 st Bank Not 3 Phase	Phase Order
High Voltage	Bank Error
Low Voltage	High Temperature
High Frequency	Temperature is Rising
Low Frequency	Low Temperature
High kW	Temperature Sensor Fail
Low kW	Alarm
Over Compensation	Fan
Insufficient Compensation	Horn
Cos over Compensation	Flashing Relay

18.2.3 RELAY PARAMETERS

Parameter Definition	Unit	Min	Max	Factory Set	Description
Learn Banks	-	0	24	0	Measures capacitor/reactor connected to specified output.
Reset Banks	-	0	1	0	Switch on timers will be reset for every output.
Reset Counters	-	0	1	0	All counters will be reset.
Manuel Connect Bank	-	0	24	0	Specified output can be energised.
Banks Number	-	0	24	24	Total number of step outputs used in compensation.
Fix Banks	-	0	24	0	Determines number of fixed banks, which will be active continuously.
Connect Time	sec	0	1638	2	Switching on delay timer for step outputs.
Disconnect Time	sec	0	1638	2	Switching off delay timer for step outputs.
Resume After C/K	sec	0	1638	2	Delay timer for switch on/switch off when reactive power changes by half of the amount of least step output power.
Discharge Time	sec	0	1638	14	Common discharge timer for all steps. Any step switched off, can not be switched on again before expiration of this timer.
Bank 1...12/24 Configuration	-	-	-	-	Manual configuration of step output powers.

18.2.4 THYRISTOR PARAMETERS

Parameter Definition	Unit	Min	Max	Factory Set	Description
Learn Banks	-	0	24	0	Measures capacitor/reactor connected to specified output.
Reset Banks	-	0	1	0	Switch on timers will be reset for every output.
Reset Counters	-	0	1	0	All counters will be reset.
Manuel Connect Bank	-	0	24	0	Specified output can be energised.
Banks Number (THY)	-	0	24	24	Total number of step outputs used in compensation.
Fix Banks	-	0	24	0	Determines number of fixed banks, which will be active continuously.
Bank 1...12/24 Configuration	-	-	-	-	Manual configuration of step output powers.

18.2.5 SVC PARAMETERS

Parameter Definition	Unit	Min	Max	Factory Set	Description
Learn SVC	-	0	1	0	Measures and records power of reactors connected to SVC outputs.
Reset SVC	-	0	1	0	Switch on timers will be reset for SVC outputs.
Manual Drive SVC	-	0	3	0	Drives SVC outputs for specified phases. 0: Switch off all SVC outputs. 1: Drive reactor on phase 1 by %100 2: Drive reactor on phase 2 by %100 3: Drive reactor on phase 3 by %100
SVC Target Ratio	%	0	50	0	Target duty cycle ratio for SVC by keeping reactive power within predefined limits.
SVC Max Open Ratio	%	50	95	50	If reactors connected to SVCs are constantly on, in order to reduce heating, duty cycle will reduce by %1 for every minute.
PID P Ratio	%	0	100	55	Do not change this parameter. It is adjusted to obtain optimum operation for SVC. You can contact with technical support for more details.
PID I Ratio	%	0	100	0	Do not change this parameter. It is adjusted to obtain optimum operation for SVC. You can contact with technical support for more details.
PID D Ratio	%	0	100	5	Do not change this parameter. It is adjusted to obtain optimum operation for SVC. You can contact with technical support for more details.
SVC Low kW Protect	kW	0.2	1000	0.2	If total power of the load is under "SVC Low kW Protect" limit, and DFC0124 can match power factor without using SVC, then SVC will be disabled.
SVC Configuration	-	-	-	-	Manual configuration of reactor powers connected to SVC.

18.3. COMMUNICATION PARAMETERS

Parameter Definition	Unit	Min	Max	Factory Set	Description
Network Setup	-	-	-	-	Parameter group consist of network parameters.
GSM Modem Parameters	-	-	-	-	Parameter group consist of GSM modem parameters.
Ethernet Parameters	-	-	-	-	Parameter group consist of ethernet parameters.
SMS Parameters	-	-	-	-	Parameter group consist of SMS parameters.
E-Mail Parameters	-	-	-	-	Parameter group consist of E-Mail parameters.
Rainbow Parameters	-	-	-	-	Parameter group consist of remote monitoring parameters.
SNTP Parameters	-	-	-	-	Parameter group consist of SNTP parameters.

18.3.1 NETWORK SETUP

Parameter Definition	Unit	Min	Max	Factory Set	Description
RS-485 Enable	-	0	1	1	RS-485 output enable/disable.
MODBUS Address	-	0	255	1	MODBUS address of the device must be specified.
RS-485 Baud Rate	Bps	2400	115200	9600	Baud rate of RS-485 communication must be adjusted.
Modem Selection	-	-	-	-	GSM modem selection must be internal for the devices that have internal GSM modem.
GPRS Connection En.	-	0	1	1	GPRS connection enable/disable.
Ethernet Enable	-	0	1	1	Ethernet connection enable/disable.
Ping Period	sec	30	900	120	The unit will check the availability of the internet connection with this interval.
Web Server Port	-	0	65535	80	This is the port number of the internal web server. The unit will answer queries to this port only.
Modbus TCP/ Port	-	0	65535	502	This is the port number of the internal Modbus TCP/IP terminal. The unit will answer Modbus requests to this port only.
Site ID	-	-	-	-	This is the site Id string sent at the beginning of SMS messages, e-mails and web page headers for the identification of the device sending the message. Any 20 character long string may be entered.
Device Serial Numb.	-	-	-	-	Device serial number string is designed to identify the current controller. This string is added to GSM-SMS messages, e-mails, web page headers etc.

18.3.2 GSM MODEM PARAMETERS

Parameter Definition	Unit	Min	Max	Factory Set	Description
APN User Name	-	-	-	-	The APN (access point name) username may be required by the GSM operator. However, some GSM operators may allow access without username. The exact information should be obtained from the GSM operator. Please search the GSM operator's website with "APN" string.
APN Password	-	-	-	-	If the APN (access point name) username is required by the GSM operator, most probably the APN password will also be required. However, some GSM operators may allow access without password. The exact information should be obtained from the GSM operator. Please search the GSM operator's website with "APN" string.
APN Name	-	-	-	-	The APN (access point name) is always required by the GSM operator. The exact information should be obtained from the GSM operator. Please search the GSM operator's website with "APN" string.
SMS Service Center Number	-	-	-	-	The SMS service center number may be required by the GSM operator. However, some GSM operators may allow SMS sending without SMS service center number. The exact information should be obtained from the GSM operator. Please search the GSM operator's website with "sms service center" string.

18.3.3 ETHERNET PARAMETERS

Parameter Definition	Unit	Min	Max	Factory Set	Description
Network IP Address	-	-	-	0.0.0.0	This is the IPv4 (internet protocol version 4) address that the unit will require from the DHCP (dynamic host control protocol) server. If this parameter is set to 0.0.0.0 then the unit will require any IPv4 address from the DHCP server. If you are not an IP professional please leave this address as "0.0.0.0".
Gateway IP Address	-	-	-	0.0.0.0	This is the router IPv4 address, If the Network IP address and Gateway IP Address are set to "0.0.0.0" then the unit will get the gateway address automatically. If you are not an IP professional please leave this address as "0.0.0.0".
Subnet Mask	-	-	-	255.255.255.0	Reserved for IP professionals. If you are not an IP professional please leave this address as "255.255.255.0".
User IP Mask 1	-	-	-	255.255.255.255	These 3 registers control the IPv4 access to the unit. The remote IPv4 address is logical AND'ed with these IP addresses. If the result gives the remote IP address, then access is enabled. Thus, access may be limited to the same LAN members (x.x.x.255) or strictly to predefined IPv4 addresses.
User IP Mask 2	-	-	-	0.0.0.0	These 3 registers control the IPv4 access to the unit. The remote IPv4 address is logical AND'ed with these IP addresses. If the result gives the remote IP address, then access is enabled. Thus, access may be limited to the same LAN members (x.x.x.255) or strictly to predefined IPv4 addresses.
User IP Mask 3	-	-	-	0.0.0.0	These 3 registers control the IPv4 access to the unit. The remote IPv4 address is logical AND'ed with these IP addresses. If the result gives the remote IP address, then access is enabled. Thus, access may be limited to the same LAN members (x.x.x.255) or strictly to predefined IPv4 addresses.
Domain Name	-	-	-	d500.dyndns-ip.com	This string is used in " Dynamic DNS " feature. The unit will register itself to the dynamic DNS server

					under this name. For more detailed information please review chapter on “ Dynamic DNS Feature ” and the document “ Dynamic DNS Account Setting ”.
Membership Address	-	-	-	members.dyndns.org	This string is used in “ Dynamic DNS ” feature. This is the address used in registering to the dynamic DNS server. For more detailed information please review chapter on “ Dynamic DNS Feature ” and the document “ Dynamic DNS Account Setting ”.
Ping Address	-	-	-	www.google.com	This internet address is regularly accessed in order to check the availability of internet access. The access period is defined in parameter Controller Configuration>Ping Period .
IP Confirmation Address	-	-	-	checkip.dyndns.org	This internet address is regularly accessed in order to read the IPv4 address of the unit.

18.3.4 SMS PARAMETERS

Parameter Definition	Unit	Min	Max	Factory Set	Description
SMS Enable	-	0	1	1	0: SMS messages disabled 1: SMS messages enabled
SMS on Output Change	-	0	1	0	This parameter controls SMS sending when any output status is changed. No warnings generated. 0: SMS on output change is disabled. 1: SMS on output change is enabled.
SMS on IP Change	-	0	1	0	This parameter controls SMS sending when IP address of GPRS connection is changed. No warnings generated. 0: No SMS on IP change 1: SMS sent on IP change
SMS1 Tel No	-	-	-	-	SMS messages will be sent to this mobile number.
SMS2 Tel No	-	-	-	-	SMS messages will be sent to this mobile number.
SMS3 Tel No	-	-	-	-	SMS messages will be sent to this mobile number.
SMS4 Tel No	-	-	-	-	SMS messages will be sent to this mobile number.

18.3.5 RAINBOW PARAMETERS

Parameter Definition	Unit	Min	Max	Factory Set	Description
Rainbow Refresh Rate	sec	0	65535	60	The unit will update the remote monitoring terminal with this rate.
Rainbow Address-1 Port	-	0	65535	90	This is the port number of the first monitoring terminal address.
Rainbow Address-2 Port	-	0	65535	90	This is the port number of the second monitoring terminal address.
Rainbow Address-1 Port Rainbow Address-2 Port	-	-	-	wss1.datakom.com.tr	This is the remote monitoring server address. Datakom remote monitoring server address is configured by default.

18.3.6 E-MAIL PARAMETERS

Parameter Definition	Unit	Min	Max	Factory Set	Description
SMTP Port	-	0	65535	587	This is the port number used for e-mail sending.
E-mail on IP Change	-	0	1	0	This parameter controls e-mail sending when IP address of GPRS or ethernet connection is changed. No warnings generated. 0: no e-mail on IP change 1: e-mail sent on IP change
Mail Account Name	-	-	-	-	This is the account name appearing in the "from" tab of the e-mail recipient. (ex: datakom-d500@gmail.com)
Mail Account Password	-	-	-	-	This is the e-mail password of above e-mail account.
Mail Server Address	-	-	-	-	This is the Outgoing Mail Server Address of the above e-mail account (ex: smtp.gmail.com)
E-Mail Address-1	-	-	-	-	These are e-mail recipient addresses where the unit is intended to send e-mail messages. Up to 3 e-mails can be sent at once.
E-Mail Address-2	-	-	-	-	These are e-mail recipient addresses where the unit is intended to send e-mail messages. Up to 3 e-mails can be sent at once.
E-Mail Address-3	-	-	-	-	These are e-mail recipient addresses where the unit is intended to send e-mail messages. Up to 3 e-mails can be sent at once.

18.3.7 SNTP PARAMETERS

SNTP (simple network time protocol) communication allows the controller to query high precision, atomic clock based date/time servers through the internet and to adjust its internal real time clock to these servers.

Thanks to the SNTP communication, the internal RTC will reach an atomic clock precision.

Parameter Definition	Unit	Min	Max	Factory Set	Description
SNTP Refresh Period	-	0	65535	30	This is the wait period between two SNTP requests of the unit in order to update its internal real time time clock from the servers.
SNTP Address 1 Port	-	0	65535	123	This is the port number of the first SNTP server.
SNTP Address 2 Port	-	0	65535	123	This is the port number of the second SNTP server.
SNTP Address 1	-	-	-	0.tr.pool.ntp.org	This is the IP address of the first SNTP server.
SNTP Address 2	-	-	-	1.tr.pool.ntp.org	This is the IP address of the second SNTP server.

18.4. MIN/MAX COUNTER SET

Parameter Definition	Unit	Min	Max	Factory Set	Description
Min/Max Restart	-	0	1	0	Restarts Min/Max values.
Counter1 (kWh1-Im)	-	-	-	0	Changes value of kWh1 Import active energy counter.
Counter2 (kWh1-Ex)	-	-	-	0	Changes value of kWh1 export active energy counter.
Counter3 (kVArh1-In)	-	-	-	0	Changes value of kVArh1 inductive energy counter.
Counter4 (kVArh1-Cp)	-	-	-	0	Changes value of kVArh1 capacitive energy counter.
Counter6 (kWh2-Im)	-	-	-	0	Changes value of kWh2 Import active energy counter.
Counter7 (kWh2-Ex)	-	-	-	0	Changes value of kWh2 export active energy counter.
Counter8 (kVArh2-In)	-	-	-	0	Changes value of kVArh2 inductive energy counter.
Counter9 (kVArh2-Cp)	-	-	-	0	Changes value of kVArh2 capacitive energy counter.
Restart All Counters	-	0	1	0	Restart all counters.

18.5. ALARM CONFIGURATION

Parameter Definition	Unit	Min	Max	Factory Set	Description
Set Voltage Alarm	-	-	-	-	Parameter group for voltage alarm parameters.
Set Frequency Alarm	-	-	-	-	Parameter group for frequency alarm parameters.
Set Active Power Alarm	-	-	-	-	Parameter group for active power alarm parameters.
Set Reactive Power Alarm	-	-	-	-	Parameter group for reactive power alarm parameters.
Set Cos Alarm	-	-	-	-	Parameter group for power factor alarm parameters.
Set Current Alarm	-	-	-	-	Parameter group for current alarm parameters.
Set THD-V Alarm	-	-	-	-	Parameter group for THD-V alarm parameters.
Set THD-I Alarm	-	-	-	-	Parameter group for THD-I alarm parameters.
Set V-Unbalance Alarm	-	-	-	-	Parameter group for V-Unbalance alarm parameters.
Set I-Unbalance Alarm	-	-	-	-	Parameter group for I-Unbalance alarm parameters.
Log Parameters	-	-	-	-	Specifies event log record conditions.
Alarm Relay Parameters	-	-	-	-	Alarm relay parameter group.

18.5.1 ALARM PARAMETER GROUP

Below parameters can be set for alarm condition;

Parameter Definition	Unit	Min	Max	Factory Set	Description
Low Alarm	-	-	-	-	Low limit of specified alarm.
High Alarm	-	-	-	-	High limit of specified alarm.
Alarm Timer	-	-	-	-	Alarm delay timer.
Stop Compensation	-	-	-	-	Compensation will stop if this parameter is active.
Latch Alarm	-	-	-	-	Latching or nonlatching alarm type can be specified. For latching alarms, even if the alarm condition is removed, the alarms will stay on and disable the operation of the the device.

18.5.2 RECORD PARAMETERS

Event logs can be recorded depending on many measurements and parameters. Event log conditions are listed below:

Alarm Event Log

Reset Event Log

Warning Event Log

Output Changed Event Log

Genset Input Event Log

Program Modified Event Log

Over Compensation Event Log

Manuel/Automatic Event Log

Insufficient Compensation Event Log

Learn Performed Event Log

Fan Status Changed Event Log

Periodic Event Log

Programming Mode Event Log

18.5.3 ALARM RELAY PARAMETERS

Parameter Definition	Unit	Min	Max	Factory Set	Description
Flashing Relay Timer	sec	1	255	1	ON and OFF timer of flashing relay.
Horn Timer	sec	0	120	60	Horn relay active timer.
Flashing Relay Active	-	0	1	0	Flashing relay enabled/disabled.
Latch Warnings	-	0	1	0	If this parameter is set to 1, all warnings will be latching type.
Flashing Relay Active	min	0	6000	0	ON timer of flashing relay.
Flashing Relay Passive	min	0	6000	0	OFF timer of flashing relay.
Alarm Mute Timer	sec	0	255	20	If the alarm is selected non-latching , then the alarm condition disappears this timer after the alarm signal goes off.
Intermittent Relay Close	-	00.00	23.59	00.00	Open time for intermittent relay.
Intermittent Relay Open	-	00.00	23.59	00.00	Close time for intermittent relay.

19. DATA RECORDING

19.1. USB FLASH MEMORY DATA RECORDING

Data can be recorded in USB flash memory. As soon as a USB flash memory is inserted, the unit will start data recording and continue until the flash memory is removed.



USB FLASH MEMORY

USB HOST
Port

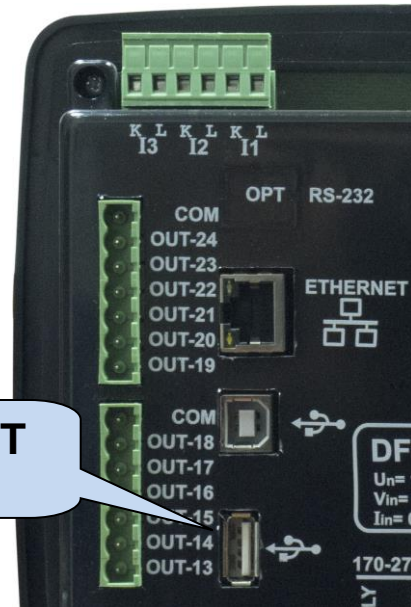

USB HOST port is available with “-C” option.



If USB-Device is plugged then USB-Host port will not function.

19.2. DIRECTORY STRUCTURE

The USB flash memory record structure of DFC0124 is explained below;

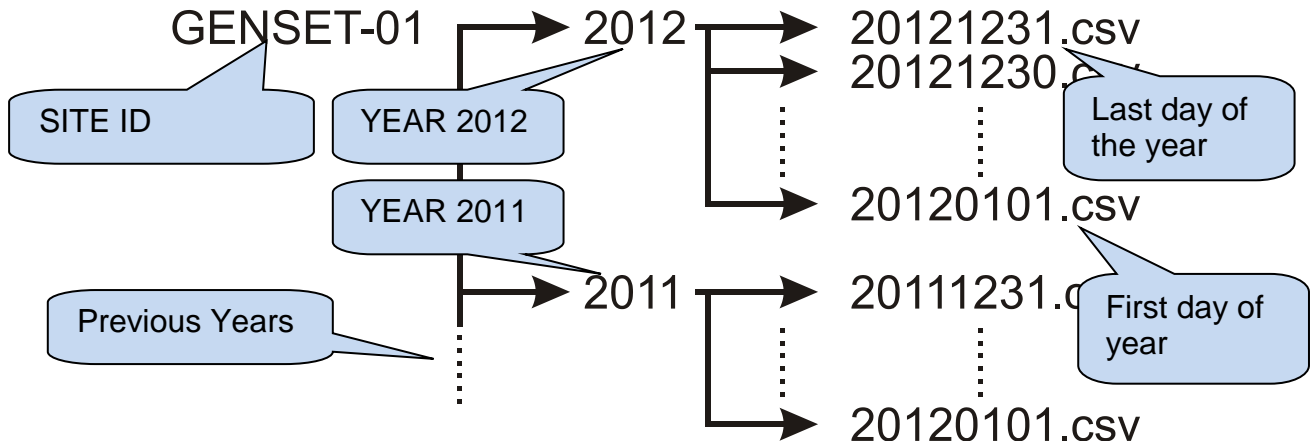

The unit will record data in a directory named with the first 11 characters of its site-id parameter. In order to avoid confusion between records, it is highly recommended to configure the site-id parameter accordingly to the installation place. Thus, the same memory module may be used for recording in different controllers,

Inside the <SITE-ID> directory, the unit will open a separate directory for each year of recording. The directory will be simply named by the year, like 2012, 2013 etc...

Inside the year directory, the controller will record data in a different file for each day of recording. The record file will be named YYYYMMDD like "20120331" representing March '31, 2012. Thus, alphabetical listing will produce a sorted list by date of recording.

The recorded file is of CSV (comma separated values) type. This is a text file which can be directly opened with Microsoft Excel program without any loss of information. It can be also opened with any text editor (like Notepad program).

Inside the file, each record consists of a line including a large set of measured parameters. The recorded parameters list is not adjustable. The controller records all practically necessary parameters.

19.3. UNDERSTANDING THE CSV FORMAT

The ".csv" file is basically a text file format. Thanks to this, it can be opened by any text editor in any operating system.

When opened with the Microsoft Excel program, the values will appear in tabulated form, enabling application of formulas, graphs and other features of Excel program.

19.4. RECORDED DATA LIST, RECORD PERIOD

The recording period is adjustable between 10 seconds and 18 hours by program parameter.

A short period will give better resolution, but it will generate more data in the memory card.

One data record is typically 250 bytes long, thus with a minimum period of 2 seconds, the unit will store 10.8 MB of data per day (250x30x60x24). A typical memory of 4GB will store data during 370 days, more than 1 year.

With a recording period of 1 minute, 4GB memory card will store data during 30 years.

Below parameters are recorded:

Date and time of recording	Mains Average Current
kWh Import Counter	Mains Phases Active Power
kWh Export Counter	Mains Total Active Power
kVarh Inductive Counter	Mains Phases Reactive Power
kVarh Capacitive Counter	Mains Total Reactive Power
Mains Phase-Neutral Voltages	Mains Total Apparent Power
Mains Phase-Phase Voltages	Mains Power Factor
Mains Phase Currents	Mains Phase Current Demand
Neutral Current	Mains Active Power Demand
Mains Frequency	Mains Reactive Power Demand
Mains Phase-Neutral Average Voltage	Mains Phase Voltages THD
Mains Phase-Phase Average Voltage	Mains Phase Currents THD

20. SNMP COMMUNICATION

The unit offers SNMP communication through its Ethernet port (10/100Mb)



The supported version of the SNMP is V1.0.

Below parameters may be read from the controller:

kWh Import Counter	Mains Total Active Power
kWh Export Counter	Mains Phase Reactive Power
kVarh Inductive Counter	Mains Total Reactive Power
kVarh Capacitive Counter	Mains Phase Apparent Power
Mains Phase-Neutral Voltages	Mains Total Apparent Power
Mains Phase-Phase Voltages	Mains Phase Power Factor
Mains Phase Currents	Mains Total Power Factor
Neutral Current	Mains Phase Current Demand
Mains Frequency	Mains Active Power Demand
Mains Phase-Neutral Average Voltage	Mains Reactive Power Demand
Mains Phase-Phase Average Voltage	Mains Phase-Neutral Voltage THD
Mains Average Current	Mains Phase-Phase Voltage THD
Mains Phase Active Powers	Mains Phase Current THD
Mains Capacitive Power Min/Max	Mains Phase Current Min/Max
Mains Export Power Min/Max	Mains Phase-Neutral Voltage Min/Max
Mains Frequency Min/Max	Mains Phase-Phase Voltages Min/Max
Mains Import Power Min/Max	Temperature
Mains Inductive Power Min/Max	

20.1. PARAMETERS REQUIRED FOR SNMP VIA ETHERNET

Modbus Slave Address: may be set between 1 and 240. If only one unit is available in the same IP address, it is advised to keep the default address (1).

Ethernet Enable: This parameter should be set to 1 (or checked) in order to enable the ethernet port.

Modbus TCP/IP Port: The usual setting is 502. However, the unit is able to work on any port address.

User IP Mask: There are 3 mask registers available. The use of the registers are emphasized in user manual. Please set the first mask as 255.255.255.0 for the proper operation.

Ethernet Network IP: May be left as 0.0.0.0 for automatic address claim or set to a value in order to claim a defined address.

Ethernet Gateway IP: Should be set in accordance with your local switch configuration.

Ethernet Subnet Mask: Should be set in accordance with your local switch configuration.

21. DECLARATION OF CONFORMITY

The unit conforms to the EU directives

- 2006/95/EC (low voltage)
- 2004/108/EC (electro-magnetic compatibility)

Norms of reference:

- EN 61010 (safety requirements)
- EN 61326 (EMC requirements)

The CE mark indicates that this product complies with the European requirements for safety, health environmental and customer protection.

22. MAINTENANCE



DO NOT OPEN THE UNIT!
There are NO serviceable parts inside the unit.

Wipe the unit, if necessary with a soft damp cloth. Do not use chemical agents.

23. DISPOSAL OF THE UNIT

Following DIRECTIVE 2002/96/EC OF THE EUROPEAN PARLIAMENT AND OF THE COUNCIL of 27 January 2003 on waste electrical and electronic equipment (WEEE), this unit should be stored and disposed separately from the usual waste.

24. ROHS COMPLIANCE

The European ROHS directive restricts and prohibits the use of some chemical materials in electronic devices.

Following the “**DIRECTIVE 2011/65/EU OF THE EUROPEAN PARLIAMENT AND OF THE COUNCIL of 8 June 2011 on the restriction of the use of certain hazardous substances in electrical and electronic equipment**”, this product is listed in annex-I under category: “**Monitoring and control instruments including industrial monitoring and control instruments**” and exempted from ROHS directive.

However, Datakom is not using any ROHS non-compliant electronic components in the production. Only the solder contains lead. The switching to unleaded soldering is in progress.