

# DKG-325 GENSET CONTROL & ATS PANEL

## DESCRIPTION

DKG-325, is a ready-to-use control and transfer panel for gasoline and diesel gensets rated up to 15kVA. It supports both 1 and 3 phase gensets.

The unit incorporates all necessary components for battery charging, genset control and load transfer between mains and genset.

Gensets may be automatized using the DKG-325, without the need for any additional equipment. Thanks to the unit, automatization of small gensets has become easy and cost effective.

In AUTO position, the unit monitors 3 phases of the mains, runs and stops the genset automatically and performs load transfer. When the engine is running, it monitors internal protections and alarm inputs.

The unit features 2 contactors, battery charging rectifier and the automatic control circuitry in one enclosure. It is the equivalent of a complete genset control panel.

Internal contactors are rated for 40Amp switching and are capable of carrying 25Amp continuously.

Fuel and crank outputs are provided through 40Amp rated relays and do not require additional relays.

The internal battery charging rectifier is rated 1Amp @12V-DC. The internal rectifier is sufficient for the float charging of the engine start battery.

The unit features 3 internal current transformers. It measures currents and power from both genset and mains.

Timers, threshold levels, input and output configurations are digitally programmable. Programs are modified through front panel pushbuttons and do not require an additional unit.

## FEATURES

- **Automatic mains monitoring**
- **Automatic load transfer**
- **Automatic starting and stopping**
- **Automatic stopping in fault condition**
- **Test mode available**
- **Emergency backup mode**
- **Internal current transformers**
- **Detailed load measurements and protections**
- **Internal battery charging rectifier**
- **40 Amp rated Fuel and Crank outputs**
- **Front panel adjustable parameters**
- **Stop, preheat and choke output capability**
- **Configurable spare digital input**
- **Survives cranking voltage dropouts**
- **Compact dimensions, flush mounted**

## MEASUREMENTS

Mains Voltages: L1-N, L2-N, L3-N  
 Mains Voltages: L1-L2, L2-L3, L3-L1  
 Genset Voltages: L1-N, L2-N, L3-N  
 Genset Voltages: L1-L2, L2-L3, L3-L1  
 Load Currents: L1, L2, L3  
 Load phase and total kW, kVA, kVAR, cos $\phi$   
 Genset Frequency  
 Battery Voltage  
 Oil pressure  
 Coolant temperature  
 Engine run Hours  
 Service Counters



## COPYRIGHT NOTICE

Any unauthorized use or copying of the contents or any part of this document is prohibited.

## ABOUT THIS DOCUMENT

This document describes minimum requirements and necessary steps for the successful installation of the DKG-325 family units.

Follow carefully advices given in the document. These are often good practices for the installation which reduce future issues.

For all technical queries please contact Datakom at below e-mail address:

**datakom@datakom.com.tr**

## QUERRIES

If additional information to this manual is required, please contact the manufacturer directly at below e-mail address:

**datakom@datakom.com.tr**

Please provide following information in order to get answers to any question:

- Device model name (see the back panel of the unit),
- Complete serial number (see the back panel of the unit),
- Firmware version (read from the display screen),
- Measuring-circuit voltage and power supply voltage,
- Precise description of the query.

## REVISION HISTORY

| REVISION | DATE       | WRITTEN | DESCRIPTION   |
|----------|------------|---------|---------------|
| 01       | 28.08.2015 | MH      | First edition |

## TERMINOLOGY



**CAUTION:** Potential risk of injury or death.



**WARNING:** Potential risk of malfunction or material damage.



**ATTENTION:** Useful hints for the understanding of device operation.

## ORDER CODES

DKG325 is available in various options and peripheral features. Please use below information for ordering the correct version:

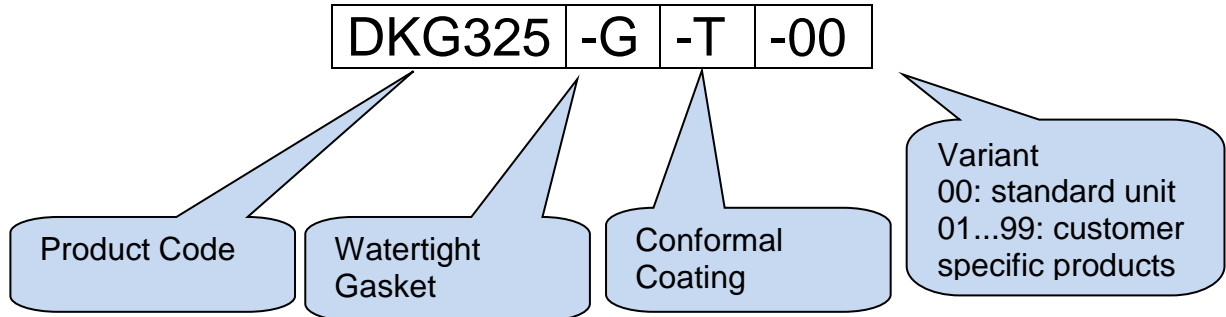

## SPARE PARTS



Screw Type Bracket  
Stock Code=J10P01 (1 unit)



Spring Type Bracket  
Stock Code=K16P01 (1 unit)

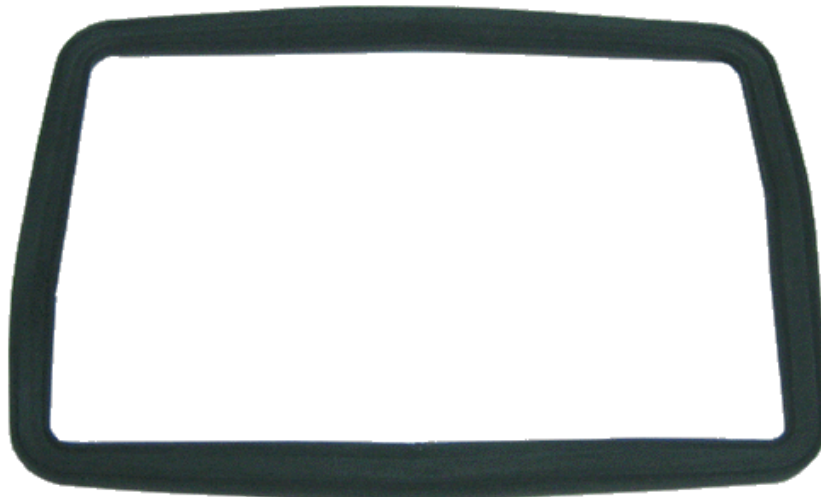

Watertight Gasket, Stock Code= K35P01



### SAFETY NOTICE

Failure to follow below instructions will result in death or serious injury



- Electrical equipment should be installed only by qualified specialist. No responsibility is assured by the manufacturer or any of its subsidiaries for any consequences resulting from the non-compliance to these instructions.

- Check the unit for cracks and damages due to transportation. Do not install damaged equipment.



- Do not open the unit. There are no serviceable parts inside.

- Fuses must be connected to the phase voltage inputs, in close proximity of the unit.

- Fuses must be of fast type (FF).

- Disconnect all power before working on equipment.



- When the unit is connected to the network do not touch terminals.



- Any electrical parameter applied to the device must be in the range specified in the user manual. Although the unit is designed with a wide safety margin, over-range parameters may reduce lifetime, alter operational precision or even damage the unit.



- Do not try to clean the device with solvent or the like. Only clean with a damp cloth.

- Verify correct terminal connections before applying power.

- Only for panel base mounting.



### WARNING

Use of fuses of higher rating than allowed may result in serious hazards.

---

## TABLE OF CONTENTS

- 1. INSTALLATION INSTRUCTIONS**
- 2. MOUNTING**
  - 2.1 DIMENSIONS**
  - 2.2 SEALING, GASKET**
  - 2.3 ELECTRICAL INSTALLATION**
- 3. TERMINAL DESCRIPTIONS**
  - 3.1. BATTERY VOLTAGE INPUT**
  - 3.2. AC VOLTAGE INPUTS**
  - 3.3. DIGITAL INPUTS**
  - 3.4. ANALOG SENDER INPUTS**
  - 3.5. CHARGE INPUT TERMINAL**
  - 3.6. LOAD OUTPUTS**
  - 3.4. DIGITAL OUTPUTS**
- 4. CONNECTION DIAGRAM**
- 5. TERMINAL DESCRIPTION**
- 6. TECHNICAL SPECIFICATIONS**
- 7. DESCRIPTION OF CONTROLS**
  - 7.1. FRONT PANEL FUNCTIONALITY**
  - 7.2. PUSHBUTTON FUNCTIONS**
  - 7.3. DISPLAY SCREEN ORGANIZATION**
  - 7.4. MEASURED PARAMETERS**
  - 7.5. LED INDICATORS**
- 8. OPERATION OF THE UNIT**
  - 8.1. QUICK START GUIDE**
  - 8.2. STOP MODE**
  - 8.3. MANUAL RUN MODE**
  - 8.4. AUTO MODEN**
- 9. PROTECTIONS AND ALARMS**
  - 9.1. SERVICE REQUEST ALARM**
  - 9.2. ALARMS**
- 10. PROGRAMMING**
- 11. CRANK CUTTING**

**TABLE OF CONTENTS (continued)****12. SOFTWARE FEATURES****12.1. REMOTE START OPERATION****12.2. MAINS SIMULATION****12.3. DELAYED MAINS SIMULATION, BATTERY CHARGING****12.4. SERVICE REQUEST DISPLAY****12.5. ENGINE HOUR METER****12.6. SOFTWARE VERSION DISPLAY****12.7. GAS ENGINE FUEL SOLENOID CONTROL****12.8. SINGLE PHASE OPERATION****13. DECLARATION OF CONFORMITY****14. MAINTENANCE****15. DISPOSAL OF THE UNIT****16. ROHS COMPLIANCE****17. TROUBLESHOOTING**

## 1. INSTALLATION INSTRUCTIONS

### **Before installation:**

- Read the user manual carefully, determine the correct connection diagram.
- Remove all connectors and mounting brackets from the unit, then pass the unit through the mounting opening.
- Put mounting brackets and tighten. Do not tighten too much, this can brake the enclosure.
- Make electrical connections with plugs removed from sockets, then place plugs to their sockets.
- Be sure that adequate cooling is provided.
- Be sure that the temperature of the environment will not exceed the maximum operating temperature in any case.

### **Below conditions may damage the device:**

- Incorrect connections.
- Incorrect battery voltage.
- Reverse battery voltage
- Voltage at measuring terminals beyond specified range.
- Voltage applied to digital inputs over specified range.
- Current at measuring terminals beyond specified range.
- Overload or short circuit at relay outputs
- Connecting or removing data terminals when the unit is powered-up.
- High voltage applied to communication ports.
- Excessive vibration, direct installation on vibrating parts.

### **Below conditions may cause abnormal operation:**

- Battery voltage below minimum acceptable level.
- Frequency out of specified limits
- Missing earthing

## 2. MOUNTING

### 2.1. DIMENSIONS

**Dimensions:** 200x148x72mm (7.9"x5.8"x2.9")  
**Panel cutout:** 176x121mm minimum (7.0"x4.8")  
**Weight:** 700g (1.5 lb)

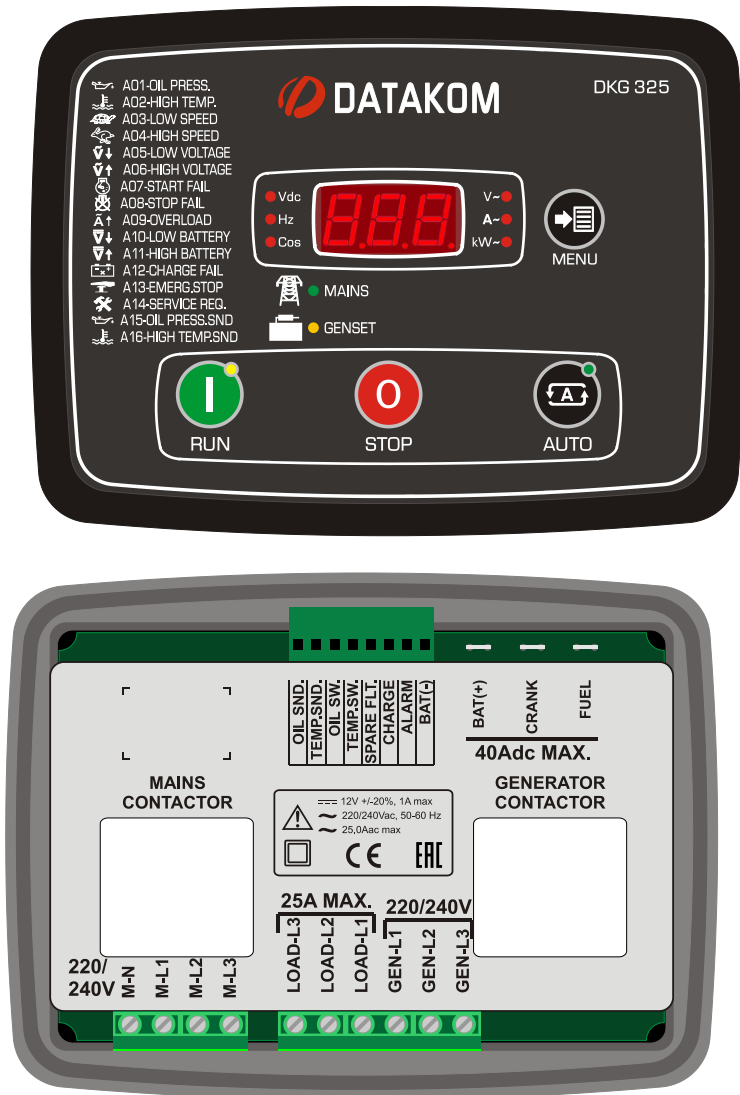

Mount the unit on a flat, vertical surface. Before mounting, remove the mounting brackets and connectors from the unit, then pass the unit through the mounting opening.

Place and tighten mounting brackets.



The module will come with one of below bracket types:



Screw type bracket



Spring type bracket



Screw type bracket installation



Spring type bracket installation

 **Do not tighten too much, this may break the unit.**

## 2.2. SEALING, GASKET

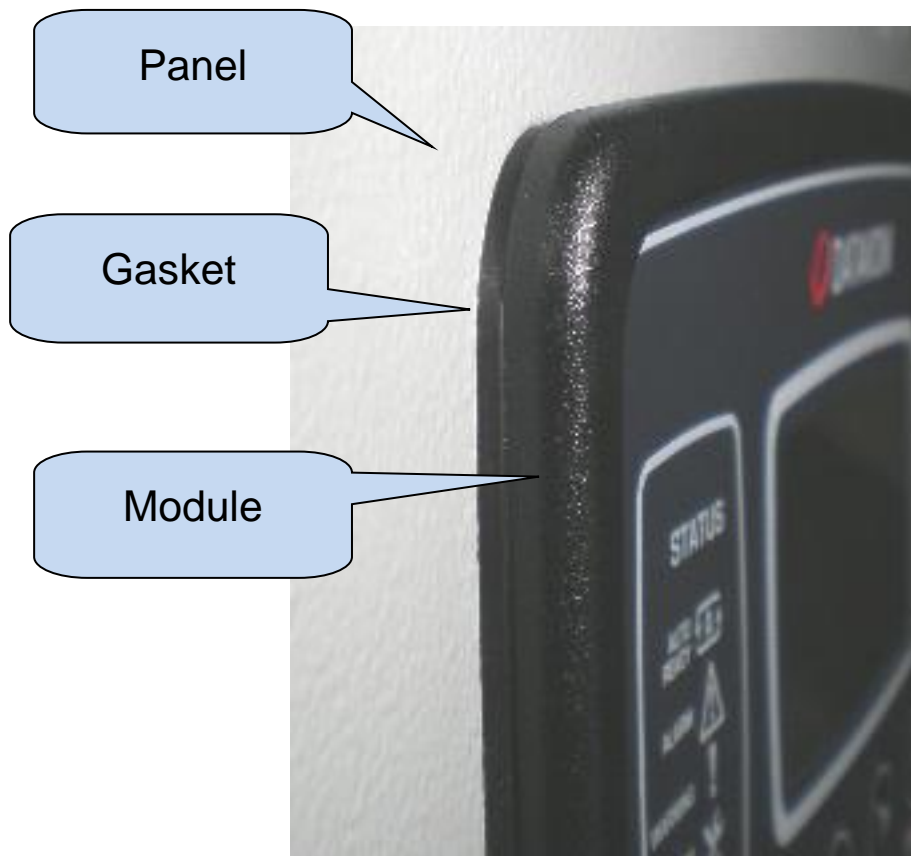

The rubber gasket provides a watertight means of mounting the module to the gasket panel. Together with the gasket, IEC 60529-IP65 protection can be reached from the front panel. A short definition of IP protection levels is given below.

### 1st Digit

- 0 Not protected
- 1 Protected against solid foreign objects of 50 mm diameter and greater
- 2 Protected against solid foreign objects of 12,5 mm diameter and greater
- 3 Protected against solid foreign objects of 2,5 mm diameter and greater
- 4 Protected against solid foreign objects of 1,0 mm diameter and greater
- 5 Protected from the amount of dust that would interfere with normal operation
- 6 Dust tight**

### 2nd Digit

- 0 Not protected
- 1 Protected against vertically falling water drops
- 2 Protected against vertically falling water drops when enclosure is tilted up to 15 °
- 3 Protected against water sprayed at an angle up to 60 ° on either side of the vertical
- 4 Protected against water splashed against the component from any direction
- 5 Protected against water projected in jets from any direction**
- 6 Protected against water projected in powerful jets from any direction
- 7 Protected against temporary immersion in water
- 8 Protected against continuous immersion in water, or as specified by the user

## 2.3. ELECTRICAL INSTALLATION



**Do not install the unit close to high electromagnetic noise emitting devices like contactors, high current busbars, switchmode power supplies and the like.**

Although the unit is protected against electromagnetic disturbance, excessive disturbance can affect the operation, measurement precision and data communication quality.

- **ALWAYS** remove plug connectors when inserting wires with a screwdriver.
- **Fuses must be connected to the battery and phase voltage inputs, in close proximity of the unit.**
- **Fuses must be of fast type (FF). AC fuses must be max 25A.**
- **Use cables of appropriate temperature range.**
- **Use adequate cable section, at least 0.75mm<sup>2</sup> (AWG18).**
- **Follow national rules for electrical installation.**



**For the correct operation, engine body must be grounded. Otherwise faulty voltage and frequency measurements may occur.**

### 3. TERMINAL DESCRIPTIONS

#### 3.1. BATTERY VOLTAGE INPUT

Battery terminals are both internal battery charger outputs and battery supply inputs.

When AC mains supply is available, the unit charges the battery. When mains voltages fail, the unit continues operation through the engine battery.

|                                   |   |
|-----------------------------------|---|
| <b>Charger output voltage:</b>    | 13.7VDC   |
| <b>Charger output current</b>     | 1.0 ADC   |
| <b>Operating voltage range:</b>   | 8 - 16VDC   |
| <b>Cranking dropouts:</b>         | Survives 0VDC during 100ms. The voltage before surge should be 9VDC minimum |
| <b>Max. Operating current:</b>    | 500mA @ 12VDC. (All features active, outputs open)                          |
| <b>Typical operating current:</b> | 250mA @ 12VDC. (All features passive, digital outputs open)                 |
| <b>Measurement range:</b>         | 0 - 36VDC   |
| <b>Display resolution:</b>        | 0.1VDC  |
| <b>Accuracy:</b>                  | 1.0% + 1 digit @ 12VDC  |



**Be sure that battery connection is not reversed. Reverse connection will damage the unit.**

#### 3.2. AC VOLTAGE INPUTS

|  |  |
|--|--|
| <b>Measurement method:</b>               | True RMS   |
| <b>Input voltage range:</b>              | 14 to 250 VAC (phase-neutral)  |
| <b>Min voltage for frequency detect:</b> | 15 VAC (Ph-N)  |
| <b>Measurement range:</b>                | 0 to 330VAC ph-N (0 to 570VAC ph-ph)   |
| <b>Input impedance:</b>                  | 4.5M-ohms  |
| <b>Display resolution:</b>               | 1VDC   |
| <b>Accuracy:</b>                         | 1.0% + 1 digit @ 230VAC ph-N ( $\pm 2$ VAC ph-N)<br>1.0% + 1 digit @ 400VAC ph-ph ( $\pm 3$ VAC ph-ph) |
| <b>Frequency range:</b>                  | DC to 100 Hz   |
| <b>Frequency display resolution:</b>     | 0.1 Hz   |
| <b>Frequency accuracy:</b>               | 0.2% + 1 digit ( $\pm 0.2$ Hz @ 50Hz)  |

### 3.3. DIGITAL INPUTS

|                               |  |
|-------------------------------|--|
| <b>Contact type:</b>          | Normally open or normally closed (programmable)                        |
| <b>Switching:</b>             | Battery negative or battery positive (programmable)                    |
| <b>Structure:</b>             | 47 k-ohms resistor to battery positive, 110k-ohms to battery negative. |
| <b>Measurement:</b>           | Analog voltage measurement.  |
| <b>Open circuit voltage:</b>  | 70% of battery voltage   |
| <b>Low level threshold:</b>   | 35% of battery voltage   |
| <b>High level threshold:</b>  | 85% of battery voltage   |
| <b>Maximum input voltage:</b> | +100VDC with respect to battery negative                               |
| <b>Minimum input voltage:</b> | -70VDC with respect to battery negative                                |
| <b>Noise filtering:</b>       | yes  |

### 3.4. ANALOG SENDER INPUTS

|                                |  |
|--------------------------------|--|
| <b>Structure:</b>              | 667 ohms resistor polarizing to 3.3VDC |
| <b>Measurement:</b>            | Analog resistor measurement.           |
| <b>Open circuit voltage:</b>   | +3.3VDC                                |
| <b>Short circuit current:</b>  | 5mA                                    |
| <b>Measurement range:</b>      | 0 to 5000 ohms.                        |
| <b>Open circuit threshold:</b> | 5000 ohms.                             |
| <b>Resolution:</b>             | 1 ohms @ 300 ohms or lower             |
| <b>Accuracy:</b>               | 2 %+1 ohm ( $\pm 7$ ohms @300 ohms)    |
| <b>Noise filtering:</b>        | yes                                    |

### 3.5. CHARGE INPUT TERMINAL

The Charge terminal is both an input and output.

When the engine is ready to run, this terminal supplies the excitation current to the charge alternator.

The excitation circuit is equivalent to a 2W lamp.

|                                       |   |
|---------------------------------------|---|
| <b>Structure:</b>                     | <ul style="list-style-type: none"> <li>• battery voltage output through 82 ohm resistor</li> <li>• voltage measurement input</li> </ul> |
| <b>Output current:</b>                | 130mA @12VDC  |
| <b>Charge Fail Warning Threshold:</b> | 6VDC  |
| <b>Open circuit voltage:</b>          | battery positive  |
| <b>Overvoltage protection:</b>        | > 500VDC continuous, with respect to battery negative   |
| <b>Reverse voltage protection:</b>    | -30VDC with respect to battery negative   |

### 3.6. LOAD OUTPUTS

|                                |  |
|--------------------------------|--|
| <b>Structure:</b>              | Genset or mains voltage through 2 internal relays. Internal current transformers on the load line. |
| <b>Max. switching current:</b> | 25A @250VAC  |
| <b>Max switching voltage:</b>  | 440VAC   |

### 3.7. DIGITAL OUTPUTS

The unit has 3 digital outputs. One of them may be selected as FUEL or STOP. The auxiliary output function may be selected from list.

|                                 |                                  |
|---------------------------------|----------------------------------|
| <b>Structure:</b>               | Positive switching relay outputs |
| <b>Max. Continuous current:</b> | Fuel & crank:40A, Auxiliary:10A  |
| <b>Max. Switching current:</b>  | 16 VDC                           |

**4. CONNECTION DIAGRAM**

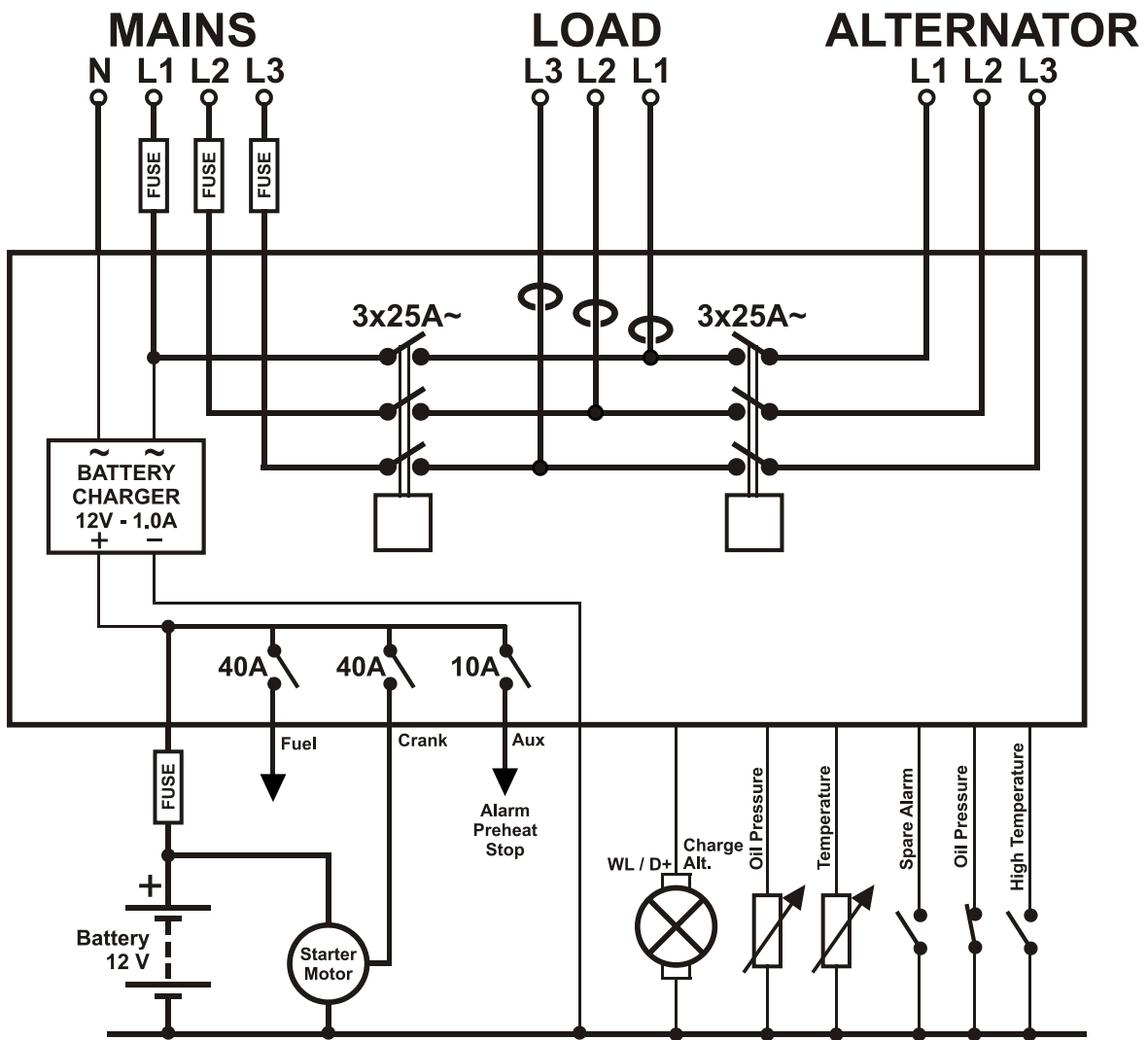
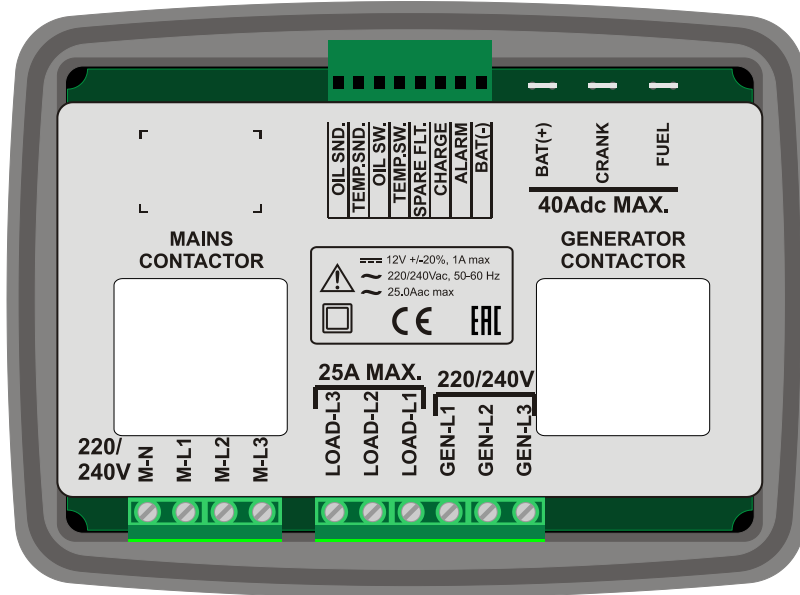

**Battery negative must be grounded.**

## 5. TERMINAL DESCRIPTION

| Term | Function      | Technical data                        | Description  |
|------|---------------|---------------------------------------|--|
| 1    | MAINS NEUTRAL | Input, 0-250V-AC                      | Neutral terminal for the mains phases.   |
| 2    | MAINS-L1      | Mains phase inputs,<br>0-250V-AC      | Connect the mains phases to these inputs. The mains voltages upper and lower limits are programmable. Mains inputs must be protected by fuses. Fuse rating must be max 25A |
| 3    | MAINS-L2      |                                       |  |
| 4    | MAINS-L3      |                                       |  |
| 5    | LOAD L3       | AC Load supply<br>output, 25A-AC max. | Supply the load from these outputs. The maximum output current rating is 25A per phase.  |
| 6    | LOAD L2       |                                       |  |
| 7    | LOAD L1       |                                       |  |
| 8    | GENSET-L1     | Genset phase inputs,<br>0-250V-AC     | Connect the genset phases to these inputs. The genset voltages upper and lower limits are programmable.  |
| 9    | GENSET-L2     |                                       |  |
| 10   | GENSET-L3     |                                       |  |



**Drawing excessive current from load outputs may damage the unit.**

| Term | Function                | Technical data                              | Description   |
|------|-------------------------|---|---|
| 11   | OIL PRESSURE SENDER     | Resistor measuring<br>input,<br>0-5000 ohms | Connect to the oil pressure sender. Do not connect the sender to other devices. The input is programmable in order to use to any sender type.                       |
| 12   | COOLANT TEMP. SENDER    |   | Connect to the coolant temperature sender. Do not connect the sender to other devices. The input is programmable in order to use to any sender type.                |
| 13   | LOW OIL PRESSURE SWITCH | Digital Inputs,<br>0-30Vdc                  | Connect to the low oil pressure switch to this terminal.  |
| 14   | HIGH TEMP SWITCH        |   | Connect to the high temperature switch to this terminal.  |
| 15   | SPARE FAULT INPUT       |   | The priority level of this input is adjustable.   |
| 16   | CHARGE                  | Input and output                            | Connect the charge alternator's D+/WL terminal to this terminal. This terminal will supply the excitation current and measure the voltage of the charge alternator. |
| 17   | AUXILIARY RELAY OUTPUT  | 10A-DC/16V-DC                               | This relay has programmable function, selectable from a list. Factory set as <b>ALARM</b> output.   |
| 18   | BATTERY NEGATIVE        | 0 VDC                                       | Power supply negative connection.   |

| Term | Function         | Technical data              | Description   |
|------|------------------|-----------------------------|---|
| 19   | BATTERY POSITIVE | +12 V-DC                    | The positive terminal of the DC Supply.                             |
| 20   | DIGITAL OUTPUT 1 | Relay Outputs<br>40A/12V-DC | <b>CRANK</b> output, capable of driving the starter motor directly. |
| 21   | DIGITAL OUTPUT 2 |                             | <b>FUEL</b> output, capable of driving the FUEL solenoid directly.  |



## 6. TECHNICAL SPECIFICATIONS

**DC Supply Range:** 9.0 - 16.0 V-DC.

**DC supply current:**

250 mA-DC typical @12V-DC

500 mA-DC max. @12V-DC

**Alternator Voltage:** 0-250 V-AC (Phase-Neutral)

**Alternator Frequency:** 0-100 Hz.

**Mains Voltage:** 0-250 V-AC (Phase-Neutral)

**Mains Frequency:** 0-100 Hz.

**Load Current:** 3x25A / 230V-AC continuous

**Cranking Dropouts:** survives 0V for 100ms.

**Fuel and Crank Relay Outputs:** 40 A / 12V-DC

**Auxiliary Output:** 10A / 12 V-DC

**Charge Excitation:** min 2 W.

**Battery Charge Current:** min 1A / 13.7V-DC (195-250V-AC)

**Operating temp.:** -40°C (-40°F) to 70°C (158°F).

**Storage temp.:** -55°C (-67°F) to 80°C (176°F).

**Maximum humidity:** 95% non-condensing.

**Dimensions:** 200x 148 x 72 mm (GxYxD)

**Panel Cutout:** 176 x 121mm minimum.

**Weight:** 700 g (approx..)

**Enclosure:** Flame retardant, high temp ABS/PC (UL94-V0)

**IP Protection:** IP54 (front).

**EU Directives**

-2006/95/EC (low voltage)

-2004/108/EC (electromagnetic compatibility)

**Reference standards for EU Conformity:**

-EN 61010 (safety)

-EN 61326 (EMC)

## 7. DESCRIPTION OF CONTROLS

### 7.1. FRONT PANEL FUNCTIONALITY

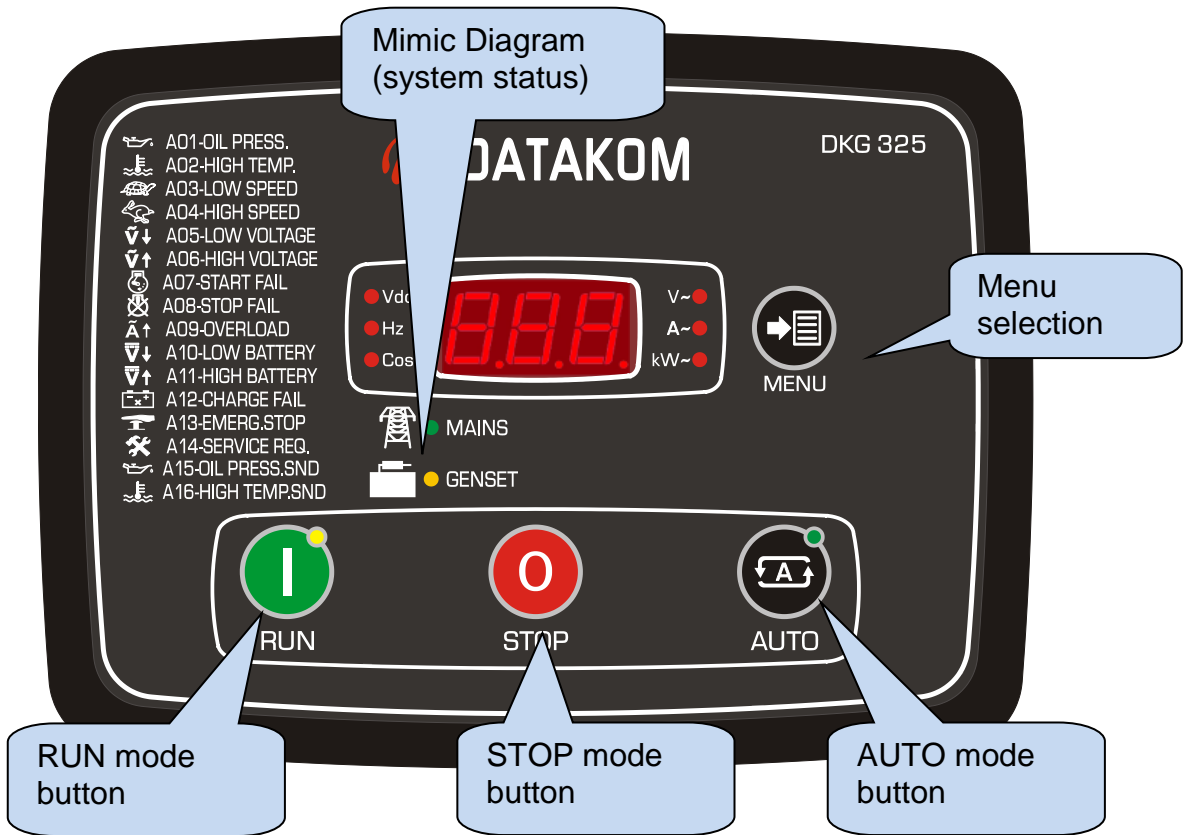

### 7.2. PUSHBUTTON FUNCTIONS

| BUTTON | FUNCTION   |
|--------|--|
|        | Selects RUN mode. The genset runs off-load.  |
|        | Selects AUTO mode. The genset runs when necessary and takes the load.  |
|        | Selects OFF mode. The genset stops.<br>If held pressed for 10 seconds, resets service counters.                      |
|        | Selects next display parameter. If held pressed, select the LAMP TEST then PROGRAMMING functions.                    |
|        | When held pressed for 5 seconds, enters a special PROGRAMMING mode where high level parameters may also be adjusted. |

### 7.3. DISPLAY SCREEN ORGANIZATION

The unit measures a large number of electrical and engine parameters. The display of the parameters is organized as a list which can be scanned by pressing the MENU button.

Each depression of the  button will cause the display to switch to the next parameter. After the last parameter the display will switch to the first parameter.

Parameter list:

**Mains phase-neutral voltages:** L1, L2, L3

**Mains phase-phase voltages:** L12, L23, L31

**Genset phase-neutral voltages:** L1, L2, L3

**Genset phase-phase voltages:** L12, L23, L31

**Load currents:** L1, L2, L3

**Total active power**

**Total cosØ**

**Genset frequency**

**Battery voltage**

**Oil pressure**

**Coolant temperature**

**Engine run hours**

**Engine run hours to service**

**Time to service**

**Firmware version**

### 7.4. MEASURED PARAMETERS

The unit performs a detailed set of AC measurements.

**The list of measured AC parameters is below:**

Mains voltage phase L1 to neutral

Mains voltage phase L2 to neutral

Mains voltage phase L3 to neutral

Mains voltage phase L1-L2

Mains voltage phase L2-L3

Mains voltage phase L3-L1

Mains frequency

Mains current phase L1

Mains current phase L2

Mains current phase L3

Mains total kW

Mains total pf

Gen voltage phase L1 to neutral

Gen voltage phase L2 to neutral

Gen voltage phase L3 to neutral

Gen voltage phase L1-L2

Gen voltage phase L2-L3

Gen voltage phase L3-L1

Gen frequency

Gen current phase L1

Gen current phase L2

Gen current phase L3

Gen average current

Gen total kW

Gen total pf

Battery voltage

Oil pressure (bar, kPa)

Coolant temperature

## 7.5. LED INDICATORS

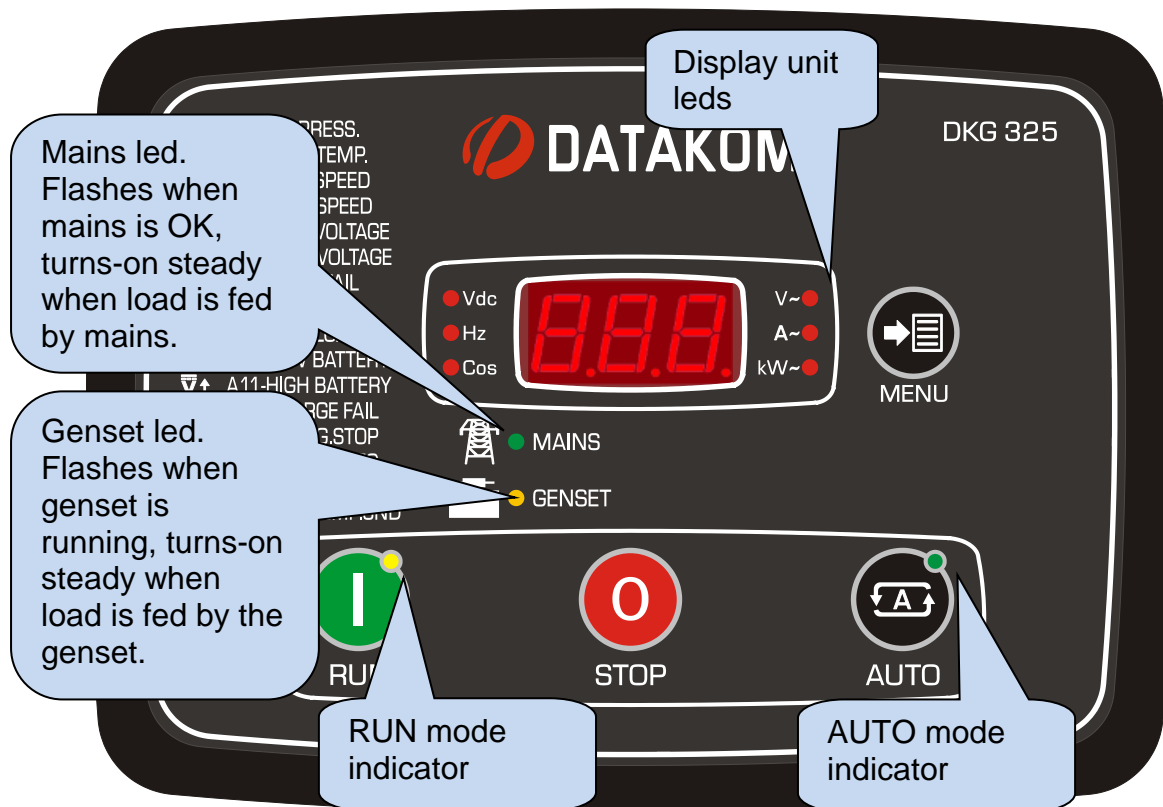

**MODE LEDS:** Turns on when related operating mode is selected.

**MAINS AND GENSET LEDS:**

**MAINS:** Flashes when all mains phase voltages and the mains frequency are within limits. Turns on when the load is fed by the mains.

**GENSET:** Flashes when all genset phase voltages and the genset frequency are within limits. Turns on when the load is fed by the genset.



If a **REMOTE START** input is defined, the **MAINS** led will reflect the status of the **REMOTE START** signal. The led is also affected by **MAINS SIMULATION** and **FORCE TO START** signals.

## 8. OPERATION OF THE UNIT

### 8.1. QUICK START GUIDE

**STOPPING THE GENSET:** Press STOP  button

**STARTING THE GENSET:** Press RUN  button

**AUTOMATIC OPERATION:** Press AUTO  button.



**Mode can be changed anytime without negative effect. Changing the operation mode while the genset is running will result into a behavior suitable for the new operating mode.**

### 8.2. STOP MODE

The STOP mode is entered by pressing the  button.

In this mode, the genset will be in a rest state.

When STOP mode is selected, if the genset is running under load, then it will be immediately unloaded. The engine will continue to run during **Cooldown Timer** and will stop afterwards.

If the STOP button is pressed again, then the engine will immediately stop.

If the engine fails to stop after the expiration of **Stop Timer** then a **Fail to Stop** warning will occur.

In this mode, the mains contactor will be energized only if mains phase voltages and frequency are within the programmed limits.

### 8.3. MANUEL RUN MODE

The RUN mode is entered by pressing the  button.

When the RUN mode is selected, the engine will be started regardless of the mains availability.



**If Emergency Backup mode is enabled and if the mains are off, then the mains contactor will be deactivated and the generator contactor will be activated.**

**When the mains are on again, a reverse changeover to the mains will be performed, but the engine will keep running unless another mode is selected.**

In order to stop the engine, press  button or select another mode of operation.

## 8.4. AUTO MODE

The AUTO mode is entered by pressing the  button.

The AUTO mode is used for the automatic transfer between genset and mains. The controller will constantly monitor the mains availability. It will run the engine and transfer the load when a mains failure occurs.

### **The mains availability evaluation sequence is below:**

- If at least one of the mains phase voltages or the mains frequency is outside limits, the mains will be supposed failing. Otherwise mains is available.
- If a Simulate Mains signal is present, then mains are made available
- If a Force to Start signal is present, then mains are unavailable
- If a Remote Start input is defined, then this signal decides of mains availability.

### **When mains are evaluated as “unavailable” then an engine start sequence begins:**

- The unit waits during Engine Start Delay for skipping short mains failures. If the mains is restored before the end of this timer, the genset will not start.
- The unit turns on the fuel and preheat glow plugs (if any) and waits for preheat timer.
- The engine will be cranked for programmed times during crank timer. When the engine fires, the crank relay will be immediately deactivated. See section **Crank Cutting** for more details.
- The engine will run unloaded during engine heating timer.
- If alternator phase voltages and frequency are correct, the unit will wait for the generator contactor period and the generator contactor will be energized.

### **When mains are evaluated as “available” again then an engine stop sequence begins:**

- The engine will continue to run for the mains waiting period to allow mains voltages to stabilize.
- Then the generator contactor is deactivated and the mains contactor will be energized after mains contactor timer.
- If a cooldown period is given, the generator will continue to run during the cooldown period.
- Before the end of cooldown, the unit will reduce the engine speed to idle speed.
- At the end of cooldown, the fuel solenoid will be de-energized, the stop solenoid will be energized for Stop Solenoid timer and the diesel will stop.
- The unit will be ready for the next mains failure.

## 9. PROTECTIONS AND ALARMS

The unit provides 3 different protection levels, being warnings, loaddumps and shutdown alarms.

- 1- **SHUTDOWN ALARMS:** These are the most important fault conditions and cause:
  - The display to show the alarm code,
  - The genset contactor to be released immediately,
  - The engine to be stopped immediately,
  - The **Alarm** digital output to operate.
- 2- **LOAD\_DUMPS:** These fault conditions come from electrical trips and cause:
  - The display to show the alarm code,
  - The genset contactor to be released immediately,
  - The engine to be stopped after Cooldown period,
  - The **Alarm** digital output to operate.
- 3- **WARNINGS:** These conditions cause:
  - The alarm code flashed on the display,
  - The **Alarm** digital output to operate.



**If a fault condition occurs, the alarm code is displayed.**

### Alarms operate in a first occurring basis:

- If a shutdown alarm is present, following shutdown alarms, loaddumps and warnings will not be accepted,
- If a loaddump is present, following loaddumps and warnings will not be accepted,
- If a warning is present, following warnings will not be accepted.



**If multiple alarms are present, they can be scanned by pressing the MENU button.**

Alarms may be of **LATCHING** type following programming.

For latching alarms, even if the alarm condition is removed, the alarms will stay on and disable the operation of the genset.



**Existing alarms may be canceled by pressing one of the operating mode buttons:**



Most of the alarms have programmable trip levels. See the programming chapter for adjustable alarm limits.

## 9.1. SERVICE REQUEST ALARM

The SERVICE REQUEST warning is designed to help the periodic maintenance of the genset to be made consistently.

The periodic maintenance is basically carried out after a given engine hours (for example 200 hours), but even if this amount of engine hours is not fulfilled, it is performed after a given time limit (for example 12 months).

The service counter set has both programmable engine hours and maintenance time limit. If any of the programmed values is zero, this means that the parameter will not be used. For example a maintenance period of 0 months indicates that the unit will request maintenance only based on engine hours, there will be no time limit. If the engine hours is also selected as 0 hours this will mean that this service counter set is not operative.

When the engine hours **OR** the time limit is over, the unit will give **A14** (SERVICE REQUEST) warning.



To reset the SERVICE PERIOD, press the  key for 10 seconds. When "Srv" is displayed, service timers are reset and the service request is erased.

The remaining engine hours and the remaining time limits are kept stored in a non-volatile memory and are not affected from power supply failures.

The time and engine hours to service are displayed in the display menu.



## 9.2. ALARMS

**A01-LOW OIL PRESSURE:** Set if a signal is detected at the Low Oil Pressure Switch. This fault will be monitored with **Holdoff Timer** delay after the engine is running.

**A02-HIGH TEMPERATURE:** Set if a signal is detected at the High Temperature Switch input.

**A03-LOW SPEED (alarm/warning):** Set if the generator frequency is below programmed limits. This fault will be monitored with **Holdoff Timer** delay after the engine is running. Limits for warning and alarm are separately programmable.

**A04-HIGH SPEED (alarm/warning):** Set if the generator frequency is above programmed limits. This fault will be monitored with **Holdoff Timer** delay after the engine is running. Limits for warning and alarm are separately programmable. Another high shutdown limit which is 12% above the high limit is always monitored and stops the engine immediately.

**A05-GENSET LOW VOLTAGE:** Set if any of the generator phase voltages goes below programmed limit for **Overload Timer**. This fault will be monitored with **holdoff timer** delay after the engine is running.

**A06-GENSET HIGH VOLTAGE:** Set if any of the generator phase voltages goes above programmed limits for **Overload Timer**. This fault will be monitored with **holdoff timer** delay after the engine is running.

**A07-START FAIL (alarm):** Set if the engine is not running after programmed number of start attempts.

**A08-STOP FAIL (warning):** Set if the engine has not stopped before the expiration of the **Stop Timer**.

**A09-OVERLOAD (load dump):** Set if at least one of the genset phase currents goes over the **Overcurrent Limit** for **Overload Timer**. Set also if the genset total active power (kW) supplied to the load goes over the **Excess Power** limit for **Overload Timer**. If currents and power go below the limit before expiration of the timer then no alarm will be set.

**A10-LOW BATTERY VOLTAGE (warning):** Set if the battery voltage goes below the programmed limit. During engine cranking this fault is not monitored.

**A11-HIGH BATTERY VOLTAGE:** Set if the battery voltage goes above programmed limits. Both warning and alarm levels for high battery voltage are programmable.

**A12-CHARGE:** Set if a charge alternator failure (or broken belt) occurs. This fault condition may result to a **warning** or **alarm** following programming.

**A13-EMERGENCY STOP (alarm/loaddump/warning):** Set if a signal is detected at the emergency stop input. The priority level of the alarm caused by this input is programmable.

**A14-SERVICE REQUEST (warning):** Set if the programmed engine hours or period is exceeded.

**A15-LOW OIL PRESSURE:** Set if the oil pressure value measured from the sender is below the programmed limit. Warning and alarm limits are separately programmable for the oil pressure sender input. This fault will be monitored with **Holdoff Timer** delay after the engine is running.

**A02-HIGH TEMPERATURE:** Set if the coolant temperature value measured from the sender is above the programmed limit. Warning and alarm limits are separately programmable for the temperature sender input.

## 10. PROGRAMMING

The program mode is used to program timers, operational limits and the configuration of the unit.

To **enter the program mode**, hold pressed the **MENU** button for 10 seconds.

When the program mode is entered, if the MENU button is pressed, the display will indicate the program parameter number. When the button is released, the display will show the parameter value.

The program mode will not affect the operation of the unit. Thus programs may be modified anytime, even while the genset is running.

Navigation between program parameters is performed via the **MENU** button. Holding the button pressed will cause the program parameter number to increase faster.

Parameter value may be increased and decreased with RUN (▼) and AUTO (▲) buttons. If these keys are held pressed, the program value will be increased/decreased faster.

When a program parameter is modified, it is automatically saved in memory.

If **MENU** button is pressed, next parameter will be displayed.

Program parameters are kept in a non-volatile memory and are not affected from power failures.

To **exit the program mode** press STOP key. If no button is pressed during 1 minute the program mode will be cancelled automatically.

Program parameters are organized in 2 groups as low and high levels. Entering the program mode by pressing the **MENU** button will allow access to only low level parameters.

In order to access all parameters please hold **STOP** and **MENU** buttons pressed together for 10 seconds.

| PGM  | Parameter Name  | Unit | Std. | Description  |
|------|---|------|------|--|
| P_01 | Fuel output type  | -    | 0    | <b>0</b> : activate to start<br><b>1</b> : activate to stop  |
| P_02 | Oil switch type   | -    | 0    | <b>0</b> : oil pressure switch<br><b>1</b> : oil level switch  |
| P_03 | Single phase operation                                      | -    | 0    | <b>0</b> : tri phased<br><b>1</b> : single phased  |
| P_04 | Overcurrent limit   | A    | 0    | If the current goes above this limit, during the period defined in <b>Overload Timeout</b> then a <b>Overcurrent Load Dump</b> alarm will be generated. If this parameter is 0 then Overcurrent check is disabled.         |
| P_05 | Excess power limit  | kW   | 0    | If the active power goes above this limit, during the period defined in <b>Overload Timeout</b> then an <b>Excess Power Load Dump</b> alarm will be generated. If this parameter is 0 then Excess Power check is disabled. |
| P_06 | Overcurrent/ Excess Power / Frequency / Voltage delay timer | sec  | 5    | This is the period between <b>OVERCURRENT</b> or <b>EXCESS POWER</b> or <b>VOLTAGE</b> or <b>FREQUENCY</b> limits are exceeded and the related alarm occurs.   |
| P_07 | Preheat timer   | Sec  | 1    | This is the time after the fuel solenoid is energized and before the genset is started. During this period the <b>PREHEAT</b> relay function is active.  |
| P_08 | Choke timer   | Sec  | 5    | This is the control delay of <b>CHOKE</b> output. The choke output is activated together with the crank output. It is released after this delay.   |
| P_09 | Engine heating timer  | Sec  | 4    | This is the period used for engine heating before genset takes the load.   |
| P_10 | Stop timer  | Sec  | 10   | This is the maximum time duration for the engine to stop. During this period the <b>STOP</b> relay function is active. If the genset has not stopped after this period, a <b>FAIL TO STOP</b> warning occurs.              |
| P_11 | Mains waiting timer   | Min  | 0.5  | This is the time between the mains voltages entered within the limits and the generator contactor is deactivated.  |
| P_12 | Cooldown timer  | min  | 1.0  | This is the period that the generator runs for cooling purpose after the load is transferred to mains.   |
| P_13 | Mains voltage low limit                                     | V    | 170  | If one of the mains phases goes under this limit, it means that the mains are off and it starts the transfer to the genset in <b>AUTO</b> mode.  |
| P_14 | Mains voltage high limit                                    | V    | 270  | If one of the mains phases goes over this limit, it means that the mains are off and it starts the transfer to the genset in <b>AUTO</b> mode.   |



Following parameters are in the “high priority” group.

| PGM  | Parameter Definition               | Unit | Fact.Set | Description   |
|------|------------------------------------|------|----------|---|
| P_15 | Genset Low Voltage Shutdown Limit  | V    | 180      | If one of the generator phase voltages goes under this limit when feeding the load, this will generate a <b>GENSET LOW VOLTAGE</b> shutdown alarm and the engine will stop.   |
| P_16 | Genset Low Voltage Warning Limit   | V    | 190      | If one of the generator phase voltages goes under this limit when feeding the load, this will generate a <b>GENSET LOW VOLTAGE</b> warning.   |
| P_17 | Genset High Voltage Warning Limit  | V    | 260      | If one of the generator phase voltages goes above this limit when feeding the load, this will generate a <b>GENSET HIGH VOLTAGE</b> warning.  |
| P_18 | Genset High Voltage Shutdown Limit | V    | 270      | If one of the generator phase voltages goes over this limit when feeding the load, this will generate a <b>GENSET HIGH VOLTAGE</b> alarm and the engine will stop.  |
| P_19 | Low Frequency Shutdown             | Hz   | 30       | If the genset frequency goes under this limit, a <b>GENSET LOW SPEED</b> alarm is generated and the engine stops.   |
| P_20 | Low Frequency Warning              | Hz   | 35       | If the genset frequency goes under this limit, a <b>GENSET LOW SPEED</b> warning is generated.  |
| P_21 | High Frequency Warning             | Hz   | 54       | If the genset frequency goes over this limit, a <b>GENSET HIGH SPEED</b> warning is generated.  |
| P_22 | High Frequency Shutdown            | Hz   | 55       | If the genset frequency goes over this limit, a <b>GENSET HIGH SPEED</b> alarm is generated and the engine stops.   |
| P_23 | Low Battery Voltage Warning        | V    | 9.0      | If the battery voltage falls below this limit, this will generate a <b>LOW BATTERY</b> warning.   |
| P_24 | High Battery Voltage Warning       | V    | 15       | If the battery voltage goes over this limit, this will generate a <b>HIGH BATTERY</b> warning.  |
| P_25 | High Battery Voltage Shutdown      | V    | 16       | If the battery voltage goes over this limit, this will generate a <b>HIGH BATTERY</b> shutdown alarm and the engine will stop.  |
| P_26 | Hysteresis Voltage                 | V    | 8        | This parameter provides the mains and genset voltage limits with a hysteresis feature in order to prevent faulty decisions.<br>For example, when the mains are present, the mains voltage low limit will be used as the programmed low limit. When the mains fail, the low limit will be incremented by this value. It is advised to set this value to 8 volts. |
| P_27 | Fault Holdoff Timer                | sec  | 12       | This parameter defines the delay after the engine runs and before the fault monitoring is enabled.  |
| P_28 | Engine Start Delay                 | sec  | 0        | This is the time between the mains fails and the fuel solenoid turns on before starting the genset. It prevents unwanted genset operation in battery backed-up loads.   |
| P_29 | Gas Solenoid Delay                 | sec  | 5        | The gas solenoid of the gas engine will be opened after this delay during cranking.   |
| P_30 | Crank Timer                        | sec  | 10       | This is the maximum start period. Starting will be automatically cancelled if the genset fires before the timer.  |
| P_31 | Wait Between Starts                | sec  | 10       | This is the waiting period between two start attempts.  |

| PGM  | Parameter Definition                      | Unit  | Fact.Set | Description  |
|------|---|-------|----------|--|
| P_32 | Genset Contactor Timer                    | sec   | 1        | This is the period after the mains contactor has been deactivated and before the generator contactor has been activated.   |
| P_33 | Mains Contactor Timer                     | sec   | 1        | This is the period after the generator contactor has been deactivated and before the mains contactor has been activated.   |
| P_34 | Number of Starts                          | -     | 3        | This is the maximum number of start attempts.  |
| P_35 | Alarm Relay Timer                         | sec   | 60       | This is the period during which the ALARM relay is active. If the period is set to 0, this will mean that the period is unlimited.   |
| P_36 | Intermittent Alarm Relay                  | -     | 0        | 0: continuous<br>1: intermittent (turns on and off every second)   |
| P_37 | Service Engine Hours                      | hour  | 50       | The SERVICE REQUEST warning (A14) will appear after this quantity of engine hours from the last service. If the period is set to '0' no SERVICE REQUEST will be generated depending on engine hours. |
| P_38 | Service Period                            | month | 6        | The SERVICE REQUEST led indicator will turn on after this amount of time from the last service. If the period is set to '0' no SERVICE REQUEST will be indicated depending on time.                  |
| P_39 | Crank Cut Frequency                       | Hz    | 10.0     | When the genset frequency reaches this limit, the engine is supposed running and the crank output will release.  |
| P_40 | Crank Stop with Oil Pressure              | -     | 0        | 0: no crank stop with oil pressure<br>1: cranking is stopped when oil pressure switch is open or the oil pressure measured is above shutdown limit.  |
| P_41 | Crank Stop with Charge                    | -     | 0        | 0: no crank stop with charge input<br>1: cranking is stopped when the charge alternator voltage is established.  |
| P_42 | Charge Alternator Shutdown                | -     | 0        | 0: The charge input generates CHARGE FAIL warning, and does not stop the engine.<br>1: The charge input generates CHARGE FAIL alarm, and stops the engine.   |
| P_43 | Line-to-Line Voltages                     | -     | 0        | 0: Display Line to Neutral voltages as default<br>1: Display Line to Line voltages as default  |
| P_44 | Emergency Backup Operation                | -     | 0        | 0: In TEST mode, the load will not be transferred to the genset even if the mains fail.<br>1: In TEST mode, the load will be transferred to the genset if the mains fail.                            |
| P_45 | Remote Start Enable                       | -     | 0        | 0: no Remote Start signal<br>1: SPARE input is Remote Start signal   |
| P_46 | Simulate Mains Enable                     | -     | 0        | 0: no Simulate Mains signal<br>1: SPARE input is Simulate Mains signal   |
| P_47 | Delayed Simulate Mains                    | -     | 0        | 0: The SPARE input has normal function<br>1: The SPARE input has delayed simulate mains function. See chapter 12.3 for more info.  |
| P_48 | Flashing Relay Timer Engine running timer | hours | 0        | <b>Delayed Simulate Mains Operation:</b> max genset running time after Simulate Mains signal disappears.<br><b>Dual Genset Systems:</b> flashing relay ON state duration timer.                      |

---

| PGM  | Parameter Definition      | Unit | Fact.Set | Description   |
|------|---------------------------|------|----------|---|
| P_49 | Low Oil Pressure Warning  | bar  | 1.5      | If the oil pressure measured from the analog input falls below this limit, this will generate a <b>LOW OIL PRESSURE SENDER</b> warning.                                 |
| P_50 | Low Oil Pressure Shutdown | bar  | 1.0      | If the oil pressure measured from the analog input falls below this limit, this will generate a <b>LOW OIL PRESSURE SENDER</b> alarm is generated and the engine stops. |
| P_51 | High Temperature Warning  | °C   | 95       | If the coolant temperature measured from the analog input goes over this limit, this will generate a <b>HIGH TEMPERATURE SENDER</b> warning.                            |
| P_52 | High Temperature Shutdown | °C   | 98       | f the coolant temperature measured from the analog input goes over this limit, this will generate a <b>HIGH TEMPERATURE SENDER</b> alarm and the engine will stop.      |

### Oil Pressure Sender Characteristics

| PGM  | Parameter Definition        | Unit | Factory Set | Description                            |
|------|-----------------------------|------|-------------|--|
| P_53 | Oil Pressure Sender Ohms -1 | ohm  | 10          | Oil Pressure Sender point 1, ohm value |
| P_54 | Oil Pressure Value -1       | bar  | 0.0         | Oil Pressure Sender point 1, bar value |
| P_55 | Oil Pressure Sender Ohms -2 | ohm  | 52          | Oil Pressure Sender point 2, ohm value |
| P_56 | Oil Pressure Value -2       | bar  | 2.0         | Oil Pressure Sender point 2, bar value |
| P_57 | Oil Pressure Sender Ohms -3 | ohm  | 90          | Oil Pressure Sender point 3, ohm value |
| P_58 | Oil Pressure Value -3       | bar  | 4.0         | Oil Pressure Sender point 3, bar value |
| P_59 | Oil Pressure Sender Ohms -4 | ohm  | 140         | Oil Pressure Sender point 4, ohm value |
| P_60 | Oil Pressure Value -4       | bar  | 7.0         | Oil Pressure Sender point 4, bar value |
| P_61 | Oil Pressure Sender Ohms -5 | ohm  | 156         | Oil Pressure Sender point 5, ohm value |
| P_62 | Oil Pressure Value -5       | bar  | 8.0         | Oil Pressure Sender point 5, bar value |
| P_63 | Oil Pressure Sender Ohms -6 | ohm  | 184         | Oil Pressure Sender point 6, ohm value |
| P_64 | Oil Pressure Value -6       | bar  | 10.0        | Oil Pressure Sender point 6, bar value |

### Coolant Temperature Sender Characteristics

| PGM  | Parameter Definition       | Unit | Factory Set | Description                           |
|------|----------------------------|------|-------------|---------------------------------------|
| P_65 | Temperature Sender Ohms -1 | ohm  | 38          | Temperature Sender point 1, ohm value |
| P_66 | Temperature Value -1       | °C   | 100         | Temperature Sender point 1, °C value  |
| P_67 | Temperature Sender Ohms -2 | ohm  | 51          | Temperature Sender point 2, ohm value |
| P_68 | Temperature Value -2       | °C   | 90          | Temperature Sender point 2, °C value  |
| P_69 | Temperature Sender Ohms -3 | ohm  | 134         | Temperature Sender point 3, ohm value |
| P_70 | Temperature Value -3       | °C   | 60          | Temperature Sender point 3, °C value  |
| P_71 | Temperature Sender Ohms -4 | ohm  | 322         | Temperature Sender point 4, ohm value |
| P_72 | Temperature Value -4       | °C   | 39          | Temperature Sender point 4, °C value  |
| P_73 | Temperature Sender Ohms -5 | ohm  | 650         | Temperature Sender point 5, ohm value |
| P_74 | Temperature Value -5       | °C   | 20          | Temperature Sender point 5, °C value  |
| P_75 | Temperature Sender Ohms -6 | ohm  | 978         | Temperature Sender point 6, ohm value |
| P_76 | Temperature Value -6       | °C   | 14          | Temperature Sender point 6, °C value  |

### Spare Input Input Configuration

| PGM  | Parameter Definition | Unit | Fac.Set | Description   |
|------|----------------------|------|---------|---|
| P_77 | Action               |      | 0       | 0: Shutdown (the engine stops immediately)<br>1: Load Dump (the engine stops after cooldown)<br>2: Warning (the horn relay operates)<br>3: No operation |
| P_78 | Sampling             |      | 0       | 0: Always<br>1: After holdoff timer<br>2: When mains present  |
| P_79 | Latching             |      | 0       | 0: Non latching<br>1: Latching  |
| P_80 | Contact type         |      | 0       | 0: Normally open<br>1: Normally closed  |
| P_81 | Switching            |      | 0       | 0: Battery negative<br>1: Battery positive  |
| P_82 | Response delay       |      | 0       | 0: No delay<br>1: Delayed (4sec)  |

The parameters below define the function of the auxiliary relay output. The relay function is selected from below list.

### Program Group: Relay Definitions

| PGM  | Parameter Definition | Unit | Fac.Set | Description                         |
|------|----------------------|------|---------|-------------------------------------|
| P_83 | Relay 01 Definition  |      | 3       | RELAY-1 function selected from list |

|    |                                  |  |  |  |     |                         |
|----|----------------------------------|--|--|--|-----|-------------------------|
| 00 | Fuel                             |  |  |  | 80  | -                       |
| 01 | Alarm                            |  |  |  | 81  | -                       |
| 02 | Start                            |  |  |  | 82  | -                       |
| 03 | Stop                             |  |  |  | 83  | -                       |
| 04 | Gen. Contactor                   |  |  |  | 84  | -                       |
| 05 | Mains Contactor                  |  |  |  | 85  | -                       |
| 06 | Choke                            |  |  |  | 86  | Spare warning           |
| 07 | Preheat                          |  |  |  | 87  | -                       |
| 08 | Shutdown alarm                   |  |  |  | 88  | Oil sender warning      |
| 09 | Shutdown or load_dump alarm      |  |  |  | 89  | Temp sender warn.       |
| 10 | Shutdown or load_dump or warning |  |  |  | 90  | Low speed warning       |
| 11 | Automatic ready                  |  |  |  | 91  | High speed warning      |
| 12 | -                                |  |  |  | 92  | -                       |
| 13 | -                                |  |  |  | 93  | -                       |
| 14 | Load_dump alarm                  |  |  |  | 94  | Fail to stop warning    |
| 15 | Fuel Main winding                |  |  |  | 95  | -                       |
| 16 | Mains Fail                       |  |  |  | 96  | Service request warning |
| 17 | -                                |  |  |  | 97  | -                       |
| 18 | -                                |  |  |  | 98  | Low battery warning     |
| 19 | -                                |  |  |  | 99  | High battery warning    |
| 20 | -                                |  |  |  | 100 | Charge fail warning     |
| 21 | Flashing Relay                   |  |  |  | 101 | -                       |
| 22 | -                                |  |  |  | 102 | -                       |
| 23 | -                                |  |  |  | 103 | -                       |
| 24 | -                                |  |  |  | 104 | Gen Low voltage warn.   |
| 25 | -                                |  |  |  | 105 | Gen High voltage warn.  |
| 26 | Idle Speed                       |  |  |  | 106 | -                       |
| 27 | -                                |  |  |  | 107 | -                       |
| 28 | -                                |  |  |  | 108 | -                       |
| 29 | -                                |  |  |  | 109 | -                       |
| 30 | -                                |  |  |  | 110 | -                       |
| 31 | -                                |  |  |  | 111 | -                       |
| 32 | Oil switch alarm                 |  |  |  | 112 | -                       |
| 33 | Temp switch alarm                |  |  |  | 113 | -                       |
| 34 | -                                |  |  |  | 114 | -                       |
| 35 | -                                |  |  |  | 115 | -                       |
| 36 | -                                |  |  |  | 116 | -                       |
| 37 | -                                |  |  |  | 117 | -                       |
| 38 | Spare Alarm                      |  |  |  | 118 | -                       |
| 39 | -                                |  |  |  | 119 | -                       |
| 40 | Oil sender alarm                 |  |  |  |     |                         |
| 41 | Temp sender alarm                |  |  |  |     |                         |
| 42 | Low speed alarm                  |  |  |  |     |                         |
| 43 | High speed alarm                 |  |  |  |     |                         |
| 44 | Low voltage alarm                |  |  |  |     |                         |
| 45 | High voltage alarm               |  |  |  |     |                         |
| 46 | Fail to start alarm              |  |  |  |     |                         |
| 47 | -                                |  |  |  |     |                         |
| 48 | -                                |  |  |  |     |                         |
| 49 | -                                |  |  |  |     |                         |
| 50 | -                                |  |  |  |     |                         |
| 51 | High battery voltage alarm       |  |  |  |     |                         |
| 52 | Charge fail alarm                |  |  |  |     |                         |
| 53 | -                                |  |  |  |     |                         |
| 54 | -                                |  |  |  |     |                         |
| 55 | -                                |  |  |  |     |                         |
| 56 | -                                |  |  |  |     |                         |
| 57 | -                                |  |  |  |     |                         |
| 58 | -                                |  |  |  |     |                         |
| 59 | -                                |  |  |  |     |                         |
| 60 | -                                |  |  |  |     |                         |
| 61 | -                                |  |  |  |     |                         |
| 62 | Spare load_dump                  |  |  |  |     |                         |
| 63 | -                                |  |  |  |     |                         |
| 64 | -                                |  |  |  |     |                         |
| 65 | -                                |  |  |  |     |                         |
| 66 | -                                |  |  |  |     |                         |
| 67 | -                                |  |  |  |     |                         |
| 68 | -                                |  |  |  |     |                         |
| 69 | -                                |  |  |  |     |                         |
| 70 | -                                |  |  |  |     |                         |
| 71 | -                                |  |  |  |     |                         |
| 72 | Overcurrent load_dump            |  |  |  |     |                         |
| 73 | Excess power Idd                 |  |  |  |     |                         |
| 74 | -                                |  |  |  |     |                         |
| 75 | -                                |  |  |  |     |                         |
| 76 | -                                |  |  |  |     |                         |
| 77 | -                                |  |  |  |     |                         |
| 78 | -                                |  |  |  |     |                         |
| 79 | -                                |  |  |  |     |                         |



## 11. CRANK CUTTING

In order to insure fast and reliable crank cutting, the unit uses various resources for engine running condition detection.

Cranking is stopped when **at least one** of below conditions is met:

**- Crank timer expired:**

The crank timer is adjusted through programming menu. The maximum allowed timer is 15 seconds.

**- Genset AC voltage over threshold:**

If the genset phase L1 AC voltage reaches **Crank Cut Voltage**, then cranking is immediately stopped.

**- Genset frequency over threshold:**

If the genset phase L1 frequency reaches **Crank Cut Frequency**, then cranking is immediately stopped.

**- Charge alternator voltage over threshold**

Following setting is necessary: **Crank Stop with Charge = 1**

If the charge alternator voltage reaches 6 volts, then cranking is immediately stopped.

**- Oil pressure above threshold**

Following setting is necessary: **Crank Cut with Oil Pressure = 1**

The crank cutting with oil pressure offers a fixed delay of 2 seconds.

Both low oil pressure switch and oil pressure sender readings may be used for crank cutting. The oil pressure switch is always used.

When oil pressure is above the Low Oil Pressure Shutdown Limit, cranking is stopped after adjustable timer delay.

## 12. SOFTWARE FEATURES

### 12.1 Remote Start Operation

The unit offers the possibility of **REMOTE START** mode of operation. The **SPARE** input may be assigned as **Remote Start Input** using the program parameter **P\_45**.

The REMOTE START signal may be a NO or NC contact, switching to either battery positive or battery negative. These selections are made using programming menu.

It is also necessary to set the **ACTION** program parameter of the **SPARE** input to **3** in order to prevent any alarm from this input using the program parameter **P\_77**.

In this mode the mains phases are not monitored. If the REMOTE START signal is present then the mains will be supposed to fail, inversely if the REMOTE START signal is absent, then mains voltages will be supposed to be present. The front panels mimic diagram's mains LEDs will reflect the status of the REMOTE START input.

### 12.2 Mains Simulation (Disable Start)

The unit offers an optional **SIMULATE MAINS** signal input. The SPARE digital input may be assigned as **Simulate Mains** using program parameter **P\_46**.

It is also necessary to set the **ACTION** program parameter of the related input to **3** in order to prevent any alarms generated from this input using the program parameter **P\_77**.

The SIMULATE MAINS signal may be a NO or NC contact, switching to either battery positive or battery negative. These selections are made using the programming menu.

If the **Simulate Mains** input is defined and the input signal is active, the mains phases are not monitored and supposed to be inside limits. This will prevent the genset from starting even in case of a mains failure. If the genset is running when the signal is applied, then usual Mains Waiting and Cooldown cycles will be performed before engine stop. When the SIMULATE MAINS signal is present, the front panels mimic diagram's mains LEDs will reflect the mains voltages as present.

When the signal is passive, the unit will revert to normal operation and monitor the mains voltage status.



**The REMOTE START operation overrides SIMULATE MAINS and FORCE TO START operations.**

## 12.3 Delayed Mains Simulation, Battery Charging

The Delayed Mains Simulation feature is used in battery backed up telecom systems where batteries are able to supply the load during a certain period. The genset is requested to run only when battery voltage drops below the critical level. Once the engine runs, the rectifier system starts charging the batteries and the battery voltage goes up immediately. Thus the engine should continue to run a programmed period for effective charging. The critical battery voltage level will be detected by an external unit which provides the digital Simulate Mains signal for the genset control unit.

The unit offers an optional **SIMULATE MAINS** signal input. The **SPARE** digital input may be assigned as **Simulate Mains** using program parameter **P\_47**.

It is also necessary to set the **ACTION** program parameter of the related input to **3** in order to prevent any alarms generated from this input using the program parameter **P\_77**.

The **SIMULATE MAINS** signal may be a NO or NC contact, switching to either battery positive or battery negative. These selections are made using the programming menu.

If the **Delayed Simulate Mains** program parameter (**P\_47**) is set to 1 and the input signal is active when the genset is not feeding the load, the mains phases are not monitored and supposed to be inside limits. This will prevent the genset from starting when the simulate mains signal is present (batteries charged). The genset will start when mains voltages are out of limits and the simulate mains signal not present.

If the genset is running when the signal is applied, then **MAINS SIMULATION** will be prevented during **P\_48 Flashing Relay Timer** program parameter. After this, usual Mains Waiting and Cooldown cycles will be performed before engine stop. When the **SIMULATE MAINS** signal is present, the front panels mimic diagram's mains LEDs will reflect the mains voltages as present.

When the signal is passive, the unit will revert to normal operation and monitor the mains voltage status.



**The REMOTE START operation overrides DELAYED SIMULATE MAINS operation. When both parameters “Remote Start Operation” and “Delayed Simulate Mains” are set then REMOTE START operation mode is performed.**

## 12.4 Service Request Display

This led is designed to help the periodic maintenance of the genset to be made consistently. The periodic maintenance is basically carried out after a given engine hours (for example 200 hours), but even if this amount of engine hours is not fulfilled, it is performed after a given time limit (for example 12 months).



**The SERVICE REQUEST warning has no effect on the genset operation.**

The unit has both programmable engine hours and maintenance time limit. The engine hours is programmable with 50-hour steps, the time limit is programmable with 1 month steps. If any of the programmed values is zero, this means that the parameter will not be used. For example a maintenance period of 0 months indicates that the unit will request maintenance only based on engine hours, there will be no time limit. If the engine hours is also selected as 0 hours this will mean that the SERVICE REQUEST display will be inoperative.

When the engine hours **OR** the time limit is over, the A14-SERVICE REQUEST warning will occur and the service request relay function will be active.

The service request relay function may be assigned to the auxiliary relay using **Relay Definition** program parameter.



**To reset the service period, press the STOP key for 5 seconds.**

The remaining engine hours and the remaining time limit are kept stored in a non-volatile memory and are not affected from power supply failures.

The time and engine hours to service are displayed by pressing the MENU button.

## 12.5 Engine Hour Meter

The unit features a non-erasable incremental engine hour meter. The hour meter information is kept in a non-volatile memory and is not affected from power supply failures.

The engine hours may be displayed by pressing the MENU button.

## 12.6 Software Version Display

Some additional features are installed within consecutive software releases. In order to be sure of the validity of the status of the unit, the software version needs to be known.

The software version may be displayed by pressing the MENU button.

## 12.7 Gas Engine Fuel Solenoid Control

The unit provides a special function for the fuel solenoid control of a gas engine.

The fuel solenoid of a gas engine is different from a diesel engine. It should be opened after the cranking has been started and should be closed between crank cycles. The delay between the crank start and solenoid opening is adjusted using the **Gas Solenoid Delay** program parameter.

The gas engine fuel solenoid relay function may be assigned to the auxiliary relays using **Relay Definition** program parameter.

## 12.8 Single Phase Operation

If the unit is used in a single phase electrical network, it is advised to set the **Single Phase Enable** program parameter to 1.

When **Single Phase Enable** is set to 1, then the unit will measure electrical parameters only on phases **L1** of genset and mains.

Voltage and overcurrent checks will be performed on phases **L1** only.

Phases **L2** and **L3** parameters, as well as phase-to-phase voltages are removed from display screens.

## 13. DECLARATION OF CONFORMITY

The unit conforms to the EU directives  
-2006/95/EC (low voltage)  
-2004/108/EC (electro-magnetic compatibility)  
Norms of reference:  
EN 61010 (safety requirements)  
EN 61326 (EMC requirements)

The CE mark indicates that this product complies with the European requirements for safety, health environmental and customer protection.

## 14. MAINTENANCE



**DO NOT OPEN THE UNIT !**  
**There are NO serviceable parts inside the unit.**

Wipe the unit, if necessary with a soft damp cloth. Do not use chemical agents.

## 15. DISPOSAL OF THE UNIT

Following **DIRECTIVE 2002/96/EC OF THE EUROPEAN PARLIAMENT AND OF THE COUNCIL of 27 January 2003 on waste electrical and electronic equipment (WEEE)**, this unit should be stored and disposed separately from the usual waste.

## 16. ROHS COMPLIANCE

The european ROHS directive restricts and prohibits the use of some chemical materials in electronic devices.

Following the “**DIRECTIVE 2011/65/EU OF THE EUROPEAN PARLIAMENT AND OF THE COUNCIL of 8 June 2011 on the restriction of the use of certain hazardous substances in electrical and electronic equipment**”, this product is listed in annex-I under category: “**Monitoring and control instruments including industrial monitoring and control instruments**” and exempted from ROHS directive.

However Datakom is not using any ROHS uncompliant electronic components in the production. Only the solder contains lead. The switching to unleaded solderin is in progress.

## 17. TROUBLESHOOTING



Below is a basic list of most often encountered troubles. More detailed investigation may be required in some cases.

### The genset operates while AC mains are OK or continues to operate after AC mains are OK:

- Check engine body grounding.
- AC mains voltages may be outside programmed limits, measure the phase voltages.
- Check the AC voltage readings by pressing the MENU button.
- Upper and lower limits of the mains voltages may be too tight. Check the parameters **Mains Voltage Low Limit** and **Mains Voltage High Limit**. Standard values are 170/270 volts.
- The hysteresis voltage may be given to excessive. The standard value is 8 volts.

### AC voltages or frequency displayed on the unit are not correct:

- Check engine body grounding, it is necessary.
- The error margin of the unit is +/- 3 volts.
- If there are faulty measurements only when the engine is running, there may be a faulty charging alternator or voltage regulator on the engine. Disconnect the charging alternator connection of the engine and check if the error is removed.
- If there are faulty measurements only when mains are present, then the battery charger may be failed. Turn off the rectifier fuse and check again.

### When the AC mains fails the unit energizes the fuel solenoid, but does not start and A01-OIL PRESSURE warning occurs:

- The unit is not supplied with battery (-) voltage at the oil pressure input.
- Oil pressure switch not connected.
  - Oil pressure switch connection wire cut.
  - Oil pressure switch faulty.
  - Oil pressure switch closes too lately. If oil pressure switch closes, the unit will start. Optionally oil pressure switch may be replaced.

### The engine does not run after the first start attempt, then the unit does not start again and A01-OIL PRESSURE warning occurs:

- The oil pressure switch closes very lately. As the unit senses an oil pressure, it does not start. When oil pressure switch closes the unit will start. Optionally the oil pressure switch may be replaced.

**When the AC mains fails, the engine starts to run but the unit gives A07-START FAIL alarm and then the engine stops:**

-The generator phase voltages are not connected to the unit. Measure the AC voltage between terminals **GEN L1-L2-L3** and **Generator Neutral** at the rear of the unit while the engine is running. A fuse protecting the generator phases may be failed. A misconnection may be occurred. If everything is OK, turn all the fuses off, and then turn all the fuses on, starting from the DC supply fuse. Then test the unit again.

**The unit is late to remove engine cranking:**

-The generator voltage rises lately. Also the generator remnant voltage is below 14 volts. The unit removes starting with the generator frequency, and needs at least 14 volts to measure the frequency. If this situation is to be avoided, please enable crank cutting with oil pressure and charge alternator voltage.

**The unit is inoperative:**

Measure the DC-supply voltage between terminals 19 and 22 at the rear of the unit. If OK, turn all the fuses off, then turn all the fuses on, starting from the DC supply fuse. Then test the unit again.

**Some program parameters are skipped:**

These parameters are reserved for factory setting and cannot be modified.

**The genset runs but does not take the load:**

Check that the genset led is flashing. Adjust genset voltage and frequency limits if necessary. Check "**Genset Contactor Timer**" program parameter.